





**CATALOGUE 21**

10th Edition

---

# WHY WE HAVE NEVER STOPPED GROWING...

Matest is an Italian company founded in 1986 by the family that still run and manage operations. Thanks to its strong capital, the company is a forerunner in technological innovation and in continuous expansion.

With an increasingly wide and comprehensive range of products, Matest is both a global player and a leading manufacturer of material testing equipment for the building industry.



1986

**MATEST**  
INNOVATIVE. GLOBAL. MANUFACTURER.

2012

**PAVETEST**  
WHERE TECHNOLOGY MEETS THE PAVEMENT.

2017

**tecnotest**<sup>®</sup>  
MATERIAL TESTING EQUIPMENT

2018

**STEELTEST**  
UNIVERSAL TESTING SYSTEMS

*...Because of our ability to constantly adapt our future strategies to stay ahead of changing customer needs, new competitors and evolving technology, while remaining a family-run company focused on medium to long-term planning.”*

There is such a lot to discover in the **10th edition** of our general catalogue, due to the dedication of the Matest team, who are the driving force behind the new products to be found in each and every sector of our range.

The synergy created with **Pavetest** has resulted in a global partnership which offers the most complete and dependable range of pavement materials testing equipment; a position confirmed by the vast majority of the market, especially customers involved in R&D, with whom we continue to develop innovative solutions.

Our awareness of having become a global player with a strong brand identity has also allowed for greater product specialization. **Steeltest** is in fact the new brand that reflects the quality and functionality inherent in our wide range of equipment for steel testing. **Tecnotest**, the company recognizable by the “Elephant” in its logo that became a well-known brand in the material testing equipment industry, is now the property of Matest, evidence of our willingness to guarantee continuity with its customers.

Our manufacturing capacity and warehouse space have been further enlarged in 2017 in order to increase productivity and accommodate higher stock levels, so as to provide better and timelier customer service; convinced as we are that this is the way forward to satisfy the market expectations.

Matest have grown by capitalizing on lessons learned and relationships created, both inside and outside the company.

**Many thanks** to our collaborators, international partners, distributors and customers, to whom we are sincerely grateful for the contributions they have made, their allegiance and commitment in sustaining the values we all share that will allow us to face future challenges...and continue growing!

**Paola Maestroni - Managing Director**  
**Roberto Maestroni - President**



## WE CALL IT SIMPLY **INNOVATION.**

Since taking its first steps into the world of concrete testing right up to the most recent and complex solutions for dynamic pavement testing, Matest continues to invest strongly into the research and development of highly-advanced technology for a sector in continuous evolution.

Its team of engineers are committed to ensuring stringent compliance of products with the major international standards, starting at the original drawing board right through to assembly and testing, without losing sight of the importance of an ergonomic and appealing design.

## APS

Dual blade concept for perfect parallel cutting.  
The next generation fully automated asphalt  
sawing system.



# THE LATEST OUTCOMES OF OUR RESEARCH.



## STS25

The most versatile static testing machine in the market today. A fully self-contained, precision engineered unit, able to perform Overlay, SCB, DCT, TSRST and DTT tests.

## PRESSUREMATIC

The best solution for geotechnical laboratories demanding automatic pressure and volume control.



## #GLOBALMANYTIMES

---

Matest brand's global presence encompasses all sectors of material testing, as witnessed by its widespread network of distributors and agents, ready to satisfy the requirements of every kind of customer on every continent.

---

## #GLOBALCUSTOMERS

---

A wide variety of customers, from research centers to general contractors, geotechnical laboratories to asphalt, concrete and cement manufacturers, government authorities and ministries to professional consultants.

---

## #GLOBALRANGE

---

More than 5,000 products, from basic equipment, strictly in compliance with the latest standards and security directives, to the most advanced system, in order to serve research entities and test all building industry materials.

---



## #GLOBAL PRESENCE

---

Strong participation in exhibitions, conferences and international events in over 150 countries.

---

## #GLOBAL SERVICE

---

A first class technical assistance provided by a team of Product Specialist, qualified in their specific field, and a solid network of experienced distributors, trained to locally serve our customers.

---

## #GLOBAL COMMUNICATION

---

A renewed, interactive web site makes consultation of our complete on-line catalogue easier and quicker. In addition to the usual product search by code, description or Standard, the new release also allows catalogue consultation by test type.

---



## MADE IN MATEST, MADE IN ITALY.

Matest's strength lies in a thorough control of the whole manufacturing process, from design to installation, according to strict quality criteria.

The year 2017 ended with further enlargement of the areas allocated for machine assembly and stocking so as to enhance quality, increase production capacity and provide faster deliveries.

Located in the province of Bergamo, Matest employees are dedicated to upholding the excellence of products Made in Italy.



# A 32 YEARS JOURNEY INTO **MANUFACTURING**, QUALITY AND WORLDWIDE EXPERIENCE.



1

Company owned  
by a single family



8,000 m<sup>2</sup>

Manufacturing  
and storage facility



8 mln

Stock of finished goods  
for just in time deliveries



1,000

Compression machines  
made in Italy per year



5,000

Items comprise the widest  
range of testing equipment



## GLOBAL QUALITY

A constant attention to quality during every stage of the manufacturing process, from the smallest basic equipment to the most technologically advanced system.

Quality assurance management is certified to ISO 9001. Matest is also accredited as Calibration Laboratory Lat No. 214 for force testing of compression machines and material testing equipment, in compliance with EN ISO/IEC 17025 and EA/ILAC requirements.



Accredited Calibration  
Laboratory n°214

LAT N. 214 Signatory of EA, IAF and ILAC Mutual  
Recognition Agreements



ISO 9001  
certified manufacturer





### Silent. Stilysh. Standout.

An inverter to enhance efficiency and reliability while further reducing energy consumption and noise during operation.

### Proprietary technology.

In-house developed technology to perform sophisticated tests, such as elastic modulus, post failure and strain tests.



## WORLDWIDE LEADING EXPERTS IN TESTING.

Matest is now recognized as a leader in the world of asphalt testing. Dominance of the patented Smartracker on the American market is an example of how the company's investment into the road pavement testing segment of the industry has given its just rewards.

Efforts in research have led to the development of machines for dynamic testing under the Pavetest brand. Pavetest proposes a range of hi-tech products suitable for both standard testing and for research purposes, while guaranteeing reliability and strong performance.

### 4PB

Stand-alone servo-pneumatic  
four point bending system



# EMBRACING A CULTURE OF TESTING.



## GROWING LEADER IN SOIL AND STEEL TESTING.

Matest has enriched its range of products with machines for performing tests on steel and soil. We are proud to welcome Steeltest, a new division dedicated to our range of universal testing machines.

And recently acquired is the historic brand Tecnotest. The famous elephant has always been appreciated by the construction material industry for the quality and the durability of its products, especially its range for geotechnical testing.

From the 2000 kN tensile machines adaptable for universal usage to the automatic and cyclic triaxial testing machines, Matest has earned itself prominent position on the national and international markets with solutions that are at the vanguard while being competitively-priced.

**STEELTEST**  
UNIVERSAL TESTING SYSTEMS

**tecnotest**<sup>®</sup>  
MATERIAL TESTING EQUIPMENT

## SHEARTRONIC

Digital shear testing machine, with incorporated data acquisition system and pneumatic vertical loading device.

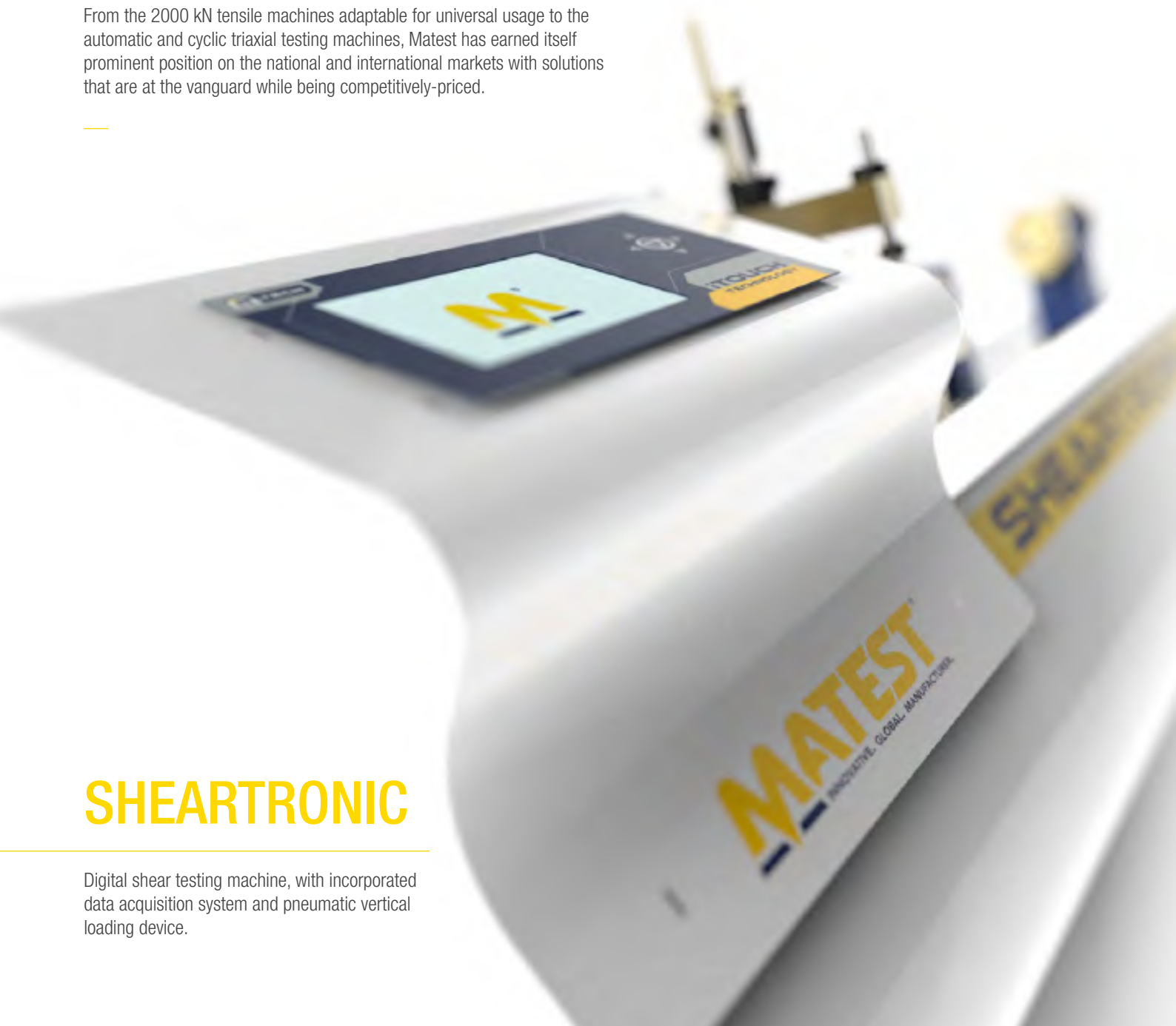

Triaxlab Automated System



Cyclic Triaxlab Automated System

Complete range of universal testing machines





# BUYER'S GUIDE

The 10th Edition of Matest catalogue contains a wide range of products, accessories and spare parts which are all identified by a specific code number and divided in sections.

## 1 Section Color

Each section is identified by a letter and a color.

## 2 Standards

The most important International Standards referring to the product are mentioned.

## 3 Main Features

This box describes the product and its main characteristics. All dimensions and weights mentioned in this catalogue are approximate and do not bind Matest company.

## 4 Product Codes

All item's codes have an initial letter, corresponding to the specific section, and a progressive number which identifies each product.

## 5 Electrical Specifications

Voltage, Phase, Frequency and Wattage information are specified at the end of the product description. Special voltages and Hz versions are available on request and have to be specified with the following codes:

24

**MATEST**  
SECTION A | AGGREGATES - ROCKS

**HIGH END LABORATORY OVENS. FORCED VENTILATION, DIGITAL THERMOSTAT**  
 HIGH TEMPERATURE UNIFORMITY UP TO 300 °C  
STANDARDS: EN 932-5 | EN 1097-5 | ASTM C127, C136, D558, D560, D698, D1557, D1559 | BS 1377 :1, 1924 :1 | UNE 103300

NEW



**A1010-01 + A1010-11**

Gasket detail



**A1010-02 + A1010-13**

Fans detail

MAIN FEATURES

- Forced ventilation airflow.
- 300 °C maximum temperature.
- High temperature (uniformity  $\pm 2\%$  and precision  $\pm 0.3$  °C) fully compliant with Standards.
- Air outlet control by valves manually operated.
- Regulation of fan speed (0-100%).
- High quality thermoinsulation material.
- Double over heat protection system.
- Low power consumption.
- Stainless steel chamber and trays with silicone gasket.
- PID electronic regulator, double digital display.

This range of laboratory ovens is designed to perform demanding thermal treatment in compliance with Standards. They are especially suitable when high temperature uniformity and precision inside the chamber are required. A temperature accuracy of  $\pm 0.3\%$  and a uniformity of  $\pm 2\%$  make this oven the best on the market. The interior chamber and the grid shelves are stainless steel made, while outside casing is in metal sheet, powder coated in gray. A sturdy double walled structure with 60 mm thick rock wool (complete lack of asbestos) and silicone gasket assure a strong thermal insulation. High-precision digital microprocessor temperature controllers fitted with self-tuning and manual PID setting allow a high temperature uniformity and accuracy reducing the energy consumption. The oven is equipped with a thermomagnetic protection and OTP (over temperature protection) to prevent accidental over-temperatures, and ensure safe working conditions. The oven is supplied complete with two grid shelves easily removable and positionable at various heights, with a pilot light and exhaust holes for fast cooling.

**Power supply:** 230V 50Hz 1ph  
400V 50Hz 3ph (for A1010-02)

Model	Capacity litres	Inside dimensions mm L D H	Outside dimensions mm L D H	Doors number	Wattage kW	Weight kg	Spare grid shelf stainless steel
<b>A1010</b>	120	550x400x580	750x780x880	1	2.2	70	<b>A1010-11</b>
<b>A1010-01</b>	220	730x500x620	930x880x915	1	4	102	<b>A1010-12</b>
<b>A1010-02</b>	420	1000x500x620	1200x930x1200	2	6.2	155	<b>A1010-13</b>

### Single Phase Power Supply

<b>STANDARD:</b>	230 V 50 Hz		(e.g. code B014 Centrifuge 230 V 1ph 50 Hz)
<b>SPECIAL:</b>	115 V 60 Hz	You have to add the letter "Y" at the end of the code	(e.g. code B014Y Centrifuge 115 V 1ph 60 Hz)
<b>SPECIAL:</b>	230 V 60 Hz	You have to add the letter "X" at the end of the code	(e.g. code B014X Centrifuge 230 V 1ph 60 Hz)
<b>SPECIAL:</b>	115 V 50 Hz	You have to add the letter "G" at the end of the code	(e.g. code B014G Centrifuge 115 V 1ph 50 Hz)

### Three Phase Power Supply

<b>STANDARD:</b>	400 V 50 Hz		(e.g. code C164 Mixer 400 V 3ph 50 Hz)
<b>SPECIAL:</b>	230 V 60 Hz	You have to add the letter "K" at the end of the code	(e.g. code C164K Mixer 230 V 3ph 60 Hz)

# INDEX

SECTION AA   <b>Software Utm2</b>	18
SECTION A   <b>Aggregates – Rocks</b>	20
SECTION B   <b>Asphalt</b>	74
SECTION B   <b>Bitumen</b>	137
SECTION B   <b>Pavement Technology</b>	169
SECTION C   <b>Concrete</b>	214
SECTION E   <b>Cement - Mortar</b>	382
SECTION H   <b>Steel</b>	432
SECTION S   <b>Soil</b>	458
SECTION V   <b>General Equipment</b>	576
INDEX   <b>Analytical Index</b>	603
INDEX   <b>Standard Index</b>	615
INDEX   <b>Product Code Index</b>	624

## UNIVERSAL TESTING MACHINE 2

### UTM2 SOFTWARE

Software developed by Matest allowing operators the management and a "User friendly" control of Matest's digital testing machines.

Software available in different languages (Italian, English, French, Spanish, German, Polish, Czech, Slovak, Turkish).

The optimal solution of laboratories for its characteristics of versatility with a wide range of customizations, for testing and research.

The ideal Software for the management of an extensive production. It contains preset profile tests according to the specifications of the EN Standards and the most common International Standards.

Flexibility, operating speed, precision and automatic storage are the fundamental characteristics of the Software conceived to facilitate the operator with few computer skills, for the management of the tests and the testing machines too.

By connecting the PC to the testing machine it is possible to perform the most complex tests just by pressing the start button. UTM2 requires a low expertise operators without any specific experience to use the software successfully (with low cost for the company).

It facilitates the printing of certificates suggesting a preset layout but changeable and customizable by the user with its own logo or others.

The software is developed on Windows platform and can be installed on old and new operative systems, from Windows XP onwards.

## General features of the UTM2

1. Automatic identification of the appliance connected.
2. Easy setting of the sequence of operations concerning the test to be made settable by the operator. The realization of a personalized testing profile savable and reusable allowing to operate following his own needs setting data and cycle test, the analogical measuring channels and the speed charts.
3. Memorization of the test in the database with the possibility to process it again.
4. Remote and interactive control of the machine.
5. Visualization of the instant loads, instant definition of the load/deformation/stroke graph, remote control of the main functions of the machine. It can also visualize the emergencies, the alarms and the eventual errors, it calculates and saves all the parameters of the test made with the possibility to process again, and to manage the test files.
6. The data test can be commented by means of test titles to be reported on the certificate or on the graph desired.
7. The user can select the calculation algorithms and , using them, the SOFTWARE will process all the results required by the Standards.
8. The colors and the graph scales of the activated windows can be freely selected by the user as well as zooming on the main interested graphic points.
9. The test certificate can be personalized with the following variables: name of the company, kind of test, date, kind of graph and number of pages.
10. Possibility to visualize into one graph and register into the archive up to no. 5 test contemporaneously, in order to dispose of a complete and global information about the tests performed for the same production batch.

## Technical specifications HARDWARE

- Processor: 312 MHz upgradable till 806 MHz
- Display LCD, QVGA (320x240 pixels) Full-color Touch-screen
- Cross Keyboard. It can completely replace the touch-screen function (for an easy use with gloves, for example)

### Hardware – Connectivity

- 1 x SD card
- 2 x USB hosts available for: mouse, keyboard, pen-drive, printer, USB Hub (to expand the number of ports), other peripherals from PC

### Hardware - I/O

- 8 Channel ADC Converter (with 2 high resolution channels for use with load cells);  
Sampling frequency: up to 200 Hz (for all the 8 channels)  
Number of bits: up to 24
- 8 digital inputs
- 8 digital outputs
- Motor ignition, Valves activation
- Expansion Connector

### Hardware - Control operation

- 2 x stepper motor controllers  
1 x standard controller, 1 x optional controller
- Brushless or stepper motor, through Expansion board

### Hardware - Storage

- Internal flash memory, dedicated to the software and to the configuration of profiles, machine, channels (including calibrations), etc.
- Unlimited memory using external memory devices SD –Card, Pen-Drive

### Hardware - Various

- On board thermic graphic printer (Accessory: C127N)
- Clock Calendar, buzzer alarm

### Software

- Operating system: “Windows Embedded CE 6.0 R3“
- User-friendly interface
- Easy updating of software and operating system
- International setting configuration  
Multilanguage interface  
Date/time/numbers formatting system  
Measurement systems (S.I.; US System)
- Software modularity  
Reference standards and tests complied through easy to install software modules
- Power calculation  
Superior calculation capacity  
Graphic representation of the test data  
Independent use from the PC

### Software - Languages

- Italian, English, French, German, Spanish, Russian, Polish, Greek, Portuguese, Dutch, Romanian, Czech. Additional languages on request

### Software - Licenses

- Every machine has an unique specific serial number
- Compliance to specific standards through dedicated license files

### Software - Record and report

- Test records: Data, Results, Chart
- Printing:  
Through on board printer (Accessory C127N)  
Through PCL printer connected to USB

### Software - “Maintenance”

- Available updates: Operating System, Applications, Licenses (backup and restore), Configuration (backup and restore), Software log
- New “UTM”: machine control through Ethernet (intranet, internet)
- Internet connection for remote assistance

## MATEST CUSTOMER SERVICE



### C104-05

#### ONLINE REMOTE ASSISTANCE PACKAGE

The machine features a connection to Internet through which Matest Customer Service provides real time support to analyze the problem, to find possible solution, and to carry out a proper test execution.



**MATEST**

# SECTION A

## AGGREGATES - ROCKS

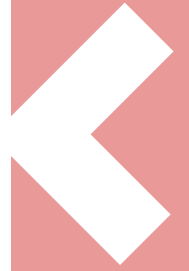

Aggregates represent the main material used in the construction industry to produce concrete, bituminous conglomerates, plasters, road and railways subgrades, etc. International and EN European Standards require many tests on different aggregate properties, including mechanical, physical, geometrical, density, strength and degradability.

A special focus is placed on Rocks with the study of its mechanical characteristics, when subjected to stress conditions such as excavations, handlings, quarries and foundations.



## GENERAL PURPOSE DRYING OVENS FORCED VENTILATION

A MORE UNIFORM TEMPERATURE WITH ON/OFF SWITCH OF THE FAN

Designed for drying, baking, conditioning and moisture determination. Sturdy manufacture, double walled with 60 mm thick glass fibre for thermal insulation.

Exterior front part is stainless steel made, while interior chamber, grid shelves and external walls are made of zinc coated steel.

Temperature from ambient to 200 °C is controlled by a **digital precision thermoregulator-indicator**. The ovens are equipped of a power switch industrial type, **dual safety thermostat** with higher thermic threshold to prevent accidental over-temperatures, and a solid-state relay (SSR) to ensure safe working conditions.

The oven is supplied complete with two grid shelves easily removable, which can be positioned at various heights, with pilot light, and exhaust holes for fast cooling.

**Power supply:** 230V 50-60Hz 1ph



**A005-04 KIT**



**A005-04 KIT** Detail of the fan

Model	Capacity litres	Inside dimensions mm L D H	Outside dimensions mm L D H	Doors n°	Wattage	Weight kg	Spare grid shelf
A007 *	50	350x360x390	590x460x620	1	750	34	A006-01
A005-01 KIT	100	400x420x600	680x685x790	1	1200	40	A007-51
A005-04 KIT	220	600x620x600	880x885x790	1	2000	60	A007-52
A005-08 KIT	440	900x690x820	1180x925x940	2	3600	85	A007-53

 **Note:** \*A007 OVEN, 50 litres capacity is natural convection.

### ACCESSORY

**A006-08** Mercury control thermometer  
0-300 °C, div. 1 °C.



**A005-08 KIT**

## LABORATORY OVENS, FORCED VENTILATION, DIGITAL THERMOSTAT HIGH TEMPERATURE UNIFORMITY AND PRECISION

STANDARDS: EN 932-5 | EN 1097-5 | BS 1924 :1

ASTM C127, C136, D558, D559, D560, D698, D1557, D1559

Especially suitable when high temperature uniformity and precision inside the chamber are required.

The temperature accuracy and uniformity meet the tolerances requested by the Standards.

The interior chamber, the grid shelves and the exterior front part are stainless steel made, while external walls are made of zinc coated steel.

Sturdy manufacture, double walled with 60 mm thick glass fibre for thermal insulation.

Temperature from ambient to 200 °C is controlled by a digital precision thermoregulator-indicator. The oven is equipped with a dual safety thermostat with higher thermic threshold to prevent accidental over-temperatures, and to ensure safe working conditions.

The oven is supplied complete with two grid shelves easily removable which can be positioned at various heights with pilot light and exhaust holes for fast cooling.

**Power supply:** 230V 50-60Hz 1ph



**A008-07 KIT**

Model	Capacity litres	Inside dimensions mm L D H	Outside dimensions mm L D H	Doors n°	Wattage	Weight kg	Spare grid shelf steel
<b>A008-01 KIT</b>	100	400x420x600	700x515x910	1	1250	45	<b>A008-51</b>
<b>A008-03 KIT</b>	220	600x610x600	900x725x910	1	2050	70	<b>A008-52</b>
<b>A008-05 KIT</b>	440	900x700x700	1250x760x1000	2	3700	95	<b>A008-53</b>
<b>A008-07 KIT</b>	750	900x640x1300	1250x700x1600	2	4950	140	<b>A008-54</b>

### MAIN FEATURES

- Forced ventilation airflow.
- Digital temperature control system.
- Temperature precision and uniformity as requested by EN, BS Spec.
- Stainless steel chamber and trays.
- Insulation by 60 mm thick glass fibres.
- Dual thermostat ensuring safe working conditions.



**A008-05 KIT**

### ACCESSORY

**A006-08** MERCURY CONTROL THERMOMETER 0-300 °C div. 1 °C.



## HIGH END LABORATORY OVENS. FORCED VENTILATION, DIGITAL THERMOSTAT

HIGH TEMPERATURE UNIFORMITY UP TO 300 °C

STANDARDS: EN 932-5 | EN 1097-5 | ASTM C127, C136, D558, D559, D560, D698, D1557, D1559 | BS 1377 :1, 1924 :1 | UNE 103300

**NEW**



**A010-01**

Gasket detail

**A010-02**

Fans detail

### MAIN FEATURES

- Forced ventilation airflow.
- 300 °C maximum temperature.
- High temperature (uniformity  $\pm 2\%$  and precision  $\pm 0.3$  °C ) fully compliant with Standards.
- Air outlet control by valves manually operated.
- Regulation of fan speed (0-100%).
- High quality thermoinsulation material.
- Double over heat protection system.
- Low power consumption.
- Stainless steel chamber and trays with silicone gasket.
- PID electronic regulator, double digital display.

This range of laboratory ovens is designed to perform demanding thermal treatment in compliance with Standards.

They are especially suitable when high temperature uniformity and precision inside the chamber are required.

A temperature accuracy of  $\pm 0.3\%$  and a uniformity of  $\pm 2\%$  make this oven the best on the market.

The interior chamber and the grid shelves are stainless steel made, while outside casing is in metal sheet, powder coated in gray. A sturdy double walled structure with 60 mm thick rock wool (complete lack of asbestos) and silicone gasket assure a strong thermal insulation.

High-precision digital microprocessor temperature controllers fitted with self-tuning and manual PID setting allow a high temperature uniformity and accuracy reducing the energy consumption.

The oven is equipped with a thermomagnetic protection and OTP (over temperature protection) to prevent accidental over-temperatures, and ensure safe working conditions.

The oven is supplied complete with two grid shelves easily removable and positionable at various heights, with a pilot light and exhaust holes for fast cooling.

**Power supply:** 230V 50Hz 1ph  
400V 50Hz 3ph (for A010-02)

Model	Capacity litres	Inside dimensions mm L D H	Outside dimensions mm L D H	Doors number	Wattage kW	Weight kg	Spare grid shelf stainless steel
<b>A010</b>	120	550x400x580	750x780x880	1	2.2	70	<b>A010-11</b>
<b>A010-01</b>	220	730x500x620	930x880x915	1	4	102	<b>A010-12</b>
<b>A010-02</b>	420	1001x469x863	1248x890x1227	2	6.2	155	<b>A010-13</b>

## A022N MUFFLE FURNACE 1100 °C

STANDARDS: EN 12697-1 clause C, EN 13108

Designed for high temperature heatings.

Structure composed of in sheet-steel, frontal furnace in diecasted steel to avoid the aggreton of the acid smokes. The thermic insulation in ceramic fibre avoids the smallest heating leakage saving energy accordingly. Electronic regulation of the temperature is obtained through a digital thermostat. This furnace is also used for the determination of residual mineral matter deriving the incineration of bituminous mixtures to (EN 12697-1 clause C Standard).

Max. temperature: 1100 °C

Chamber stability:  $\pm 1$  °C

Chamber uniformity:  $\pm 10$  °C

The chamber is muffle made and it is not suitable to test aggressive chemical samples.

Inside dimensions: 200x300x133 mm

Useful Volume: 8.2 litres

**Outside dimensions:** 440x620x510 mm

**Power supply:** 230V 1ph 50-60Hz 1.8kW

**Weight:** 30 kg approx.

## A024N CERAMIC FURNACE 1200 °C

STANDARDS: EN 196-2, 196-21, 459-2

Used to determine the loss on ignition of cement and lime; chloride, carbon dioxide, alkali content of cement.

Max. temperature: 1200 °C

Chamber stability:  $\pm 1$  °C

Chamber uniformity:  $\pm 10$  °C

The chamber, ceramic made, is resistant to aggressive chemical material samples.

Inside dimensions: 120x295x100 mm

Useful volume: 4 litres \*

**Outside dimensions:** 440x560x500 mm

**Power supply:** 230V 1ph 50-60Hz 3.7kW

**Weight:** 60 kg approx.

 **Note:** \* the Muffle Furnace 1200 °C model is available on request also with volume capacity of: 7.2, 12 or 15 litres.

 NEW



A024N



A022N

## A023-01N MUFFLE FURNACE 1100 °C HIGH CAPACITY

This furnace is also suitable for the "Determination of resistance to thermal shock of aggregates according to EN 1367-5 Specification".

Max. temperature: 1100 °C

Chamber stability:  $\pm 1$  °C

Chamber uniformity:  $\pm 10$  °C

The chamber is muffle made and it is not suitable to test aggressive chemical samples.

Inside dimensions: 315x495x240 mm

Useful volume: 39 litres

**Outside dimensions:** 650x900x740 mm

**Power supply:** 400V 3ph 50-60Hz 6kW

**Weight:** 80 kg approx.

 NEW



A023-01N

ACCESSORY for all Muffle Furnaces

A023-11N TEMPERATURE OMRON PROGRAMMER.

## CLIMATIC CABINETS



The climatic cabinet is available in two versions:

- **C313N** Temperature and humidity controlled from -30 to +70 °C and 20% to 95% respectively for testing concrete, cement, aggregates and many other applications.
- **C316N** Only temperature controlled from -30 to +70 °C for the determinations of the behavior and resistance to freezing and thawing of aggregates and different other applications on concrete and building materials.

### MAIN FEATURES

- Real-Time display of temperature and humidity parameters.
- High quality thermal insulation material.
- Temperature control from -30 to +70 °C with high stability ( $\pm 0.15$  °C).
- Humidity control from 20% to 95% with  $\pm 5\%$  stability and  $\pm 1\%$  accuracy (within temperature +10 to +70 °C).

### C313N TEMPERATURE AND HUMIDITY CONTROLLED CABINET 535 LITRES CAPACITY

STANDARDS: EN 196-1, EN 1367-1, EN 12390-9

Designed for all research and control laboratories to perform: cold and/or hot temperature measurement at controlled humidity conditions, any kind of freezing/thawing tests and accelerated curing tests. Used to cure concrete and cement specimens and analyze the behavior to freezing and thawing of aggregates and concrete. Internal and external frame is made of stainless steel AISI 304. Polyurethane insulation: 60 mm thick.

Internal ventilation.

Door with 180° opening angle, equipped magnetic gasket and integrated heater against freezing.

Shelves can be taken off and adjustable in height; adjustable feet.

Temperature and humidity sensors wall mounted inside cabinet. The cabinet is supplied with a two stage filter; mechanic and mixed ionic/cationic resins. It works with demineralized, softened waters, or tap water with hardness rate up to 300 ptm assuring an excellent functioning along the time.

Equipped with microprocessor temperature/humidity controller with integrated cycles multiple segments programmer.

- panel mount 144x130mm format
- 5" color graphic display
- 50 programs with 100 segments and real time clock
- Logging function with PC interface (optional)

Visual alarm for minimum and maximum temperature

Supplied complete with 3 adjustable shelves suitable to withstand weights up to 40 kg

**Inside dimensions:** 590x670x1360 mm

**Overall dimensions:** 710x820x2080 mm

**Power supply:** 230V 1ph 50-60Hz 2570W

**Weight:** 170 kg approx.



**C313N**

### C313-01N TEMPERATURE AND HUMIDITY CONTROLLED CABINET 1200 LITRES CAPACITY

Same as C313N model, but with an internal capacity of 1200 liters. Internal ventilation. Door with 180° opening angle, equipped magnetic gasket and integrated heater against freezing.

Shelves can be taken off and adjustable in height; adjustable feet.

Temperature and humidity sensors wall mounted inside cabinet

Visual alarm for minimum and maximum temperature

Supplied complete with 6 adjustable shelves suitable to withstand weights up to 40kg.

**Inside dimensions:** 1300x670x1360 mm

**Overall dimensions:** 1500x820x2080 mm

**Power supply:** 230V 1ph 50-60Hz 2900W

**Weight:** 230 kg approx.

#### Note:

as far the C313N and C313-01N performances, the humidity range indicated in the product description may be narrower vs. the given interval depending on the selected temperature. Please contact our sales team to investigate the suitability for your requirements.

## C316N TEMPERATURE CONTROLLED CABINET

535 LITRES CAPACITY

STANDARDS: EN 1367-1

Technical specifications:

Same as mod. C313N, except for the humidity control that is not included.

### ACCESSORIES

**C313-11N** ADDITIONAL BASKET SHELVE : Made of Stainless Steel grid, suitable for loads up to 40 Kg.

**C313-12N** MOBILE TEMPERATURE PROBE: Type PT100 in stainless steel bulb for free positioning in the chamber and on the specimen.

**C313-13N** LOGGING FUNCTION: Logging upgrade function for on-board Jumo controller with enabling of "real time trend" and "Historical trend" of variables and predisposition of PC interface.

**C313-15N** PC INTERFACE: Consist of Cables, PC interface converter and Jumo software for editing and real-time view.

**ADHESIVES FOR TILES**  **NEW**  
DETERMINATION OF TENSILE ADHESION  
STRENGTH FOR CEMENTITIOUS ADHESIVES  
STANDARDS: EN 1348 | EN 12004

## C313-05N INTERNAL FLOODING SYSTEM

Applicable only to temperature and humidity controlled cabinets C313N, C313-01N.

Used for the determination of tensile adhesion strength for cementitious adhesives.

It is composed of two stainless steel vessels and a discharging system for the water.

The system allows to empty and fill the inner vessel with water without opening the climatic cabinet.

Inner vessel water level is limited by a sensor.

Filling and drainage of water are regulated by a valve positioned on the bottom of both vessels.

Inner vessel volume is 150 l, while outer vessel volume is 170 l.

Water temperature range is from 10 °C to 40 °C, demineralized water must be used.

Temperature stability:  $\pm 2$  °C

Water pressure range is from 0.2 to 5 bar.

Flooding system can be installed also in C313 already supplied if returned in Matest factory.

System must work with no organic compounds.

### Outer vessel dimensions:

816x588x600 mm

**Weight:** 50 kg approx.



C313N + C313-05N



Control panel



Two stage filter

**A106T  
MELTING POT**

Stainless steel cup with a capacity of approximately two litres, it is used to melt wax and other materials. Suitable also for general laboratory purposes.

Temperature range: from +45 °C to +320 °C

Capacity: 2 litres

**Dimensions:** 400x280x200(h) mm.

**Power supply:** 220V 50Hz 1ph 500W

**Weight:** 3.2 kg approx.

**A106T**
**HOT PLATES**, complete with thermoregulator

**Power supply:** 230V 1ph 50-60Hz

**MODELS**

<b>V200</b>	Round Ø 185 mm - 1500 W
<b>V200-02</b>	Round Ø 220 mm - 2000 W
<b>B074</b>	Round Ø 160 mm - 1000 W
<b>V200-01N</b>	Rectangular 200x300 mm - 1500 W
<b>V200-03N</b>	Square 380x380 mm - 2000 W
<b>V200-05N</b>	Rectangular 400x500 mm - 2000 W
<b>V200-06N</b>	Rectangular 400x600 mm - 2000 W

**B073-01**

**B073-01  
MAGNETIC STIRRER | HEATER**

Used for titration and stirring of liquid and semi-solid materials. Plate Ø 150 mm.

Electronic regulators for variable speed and temperature.

Supplied complete with magnetic teflon coated follower.

**Power supply:** 230V 1ph 50Hz 400W

**A106  
MELTING POT**

Used to melt wax and other materials, it maintains heat from room temperature to max. 350 °C.

Complete with adjustable thermostat range +50 °C to +350 °C, accuracy ± 1.5 °C pilot lamp fully isolated to CE requirements.

**Capacity:** 5 litres

**Internal dimensions:** Ø 200x160 mm

**Power supply:** 230V 50-60Hz 1ph 800W

**Weight:** 3 kg

**A106**
**A106-01**
**A106-01  
MELTING POT**

Similar to the above A106 but with capacity of 12 litres.

**Internal dimensions:** Ø 270x200 mm

**Power supply:** 230V 50-60Hz 1ph 1400W

**Weight:** 8.2 kg approx.

**ACCESSORY**

**V300-19** PARAFFIN WAX, for general laboratory use, having melting point at 50-54 °C. Pack of 5 kg

**B074**
**V200**
**V200-05N**

**V200-01N**
**A009  
MICROWAVE OVEN**

Used for speed drying purposes, moisture determination and conditioning.

**Power supply:** 230V 50Hz 1ph 700W

**Weight:** 12 kg approx.

**A009**

## A028 UNIVERSAL CARBIDE METER

For a rapid and accurate determination of moisture content in sand, gravel, aggregates, soil etc, based on the calcium carbide method. It is possible to vary the sample weight from 3 to 100 g achieving a moisture range from 50% (3g) - 10% (20g) - 2% (100g). The bottle is calibrated and equipped with a surface thermometer. The glass ampoule containing the calcium carbide is broken when the bottle is closed and shaken, granting better accuracy to the test. The instrument comprises the testing bottle with manometer, small balance, 25 ampoules of reagent, accessories, case.

**Dimensions:** 520x340x140 mm

**Weight:** 6 kg approx.



## A028 SP UNIVERSAL CARBIDE METER

Same as mod. A028, but with a larger bottle suitable to use 20 g sample weight with a moisture content up to 20%.

## A028-01 DIGITAL UNIVERSAL CARBIDE METER

Same as mod. A028, but with digital manometer for more accurate readings with pressure and temperature display. Supplied complete.

## A028-02 DIGITAL UNIVERSAL CARBIDE METER

Same as mod. A028-01, with protocol printer to obtain test certificate with up to 7 pressure / time logs.

**Weight:** 8 kg approx.

A028-02



## A028-12 CALIBRATION KIT

For the universal carbide meters A028, complete with manometer and accessories.

## SPARE

**A028-11**  
Carbide Ampoules (pack of 100)



A028-11

## SPEEDY MOISTURE TESTERS

For accurate moisture reading on field of soil, sand, aggregates. The test system uses the reaction between water and calcium carbide forming a gas. Complete with electronic balance, reagent tin, accessories; the whole contained in a portable moulded case.

## MODELS

### A025 KIT SPEEDY MOISTURE TESTER 6 GRAMS CAPACITY.

**Moisture range:** 0 - 20%

**Weight:** 6 kg approx.

### A026 KIT SPEEDY MOISTURE TESTER 20 GRAMS CAPACITY.

**Moisture range:** 0 - 20%

**Weight:** 8 kg approx.

A025 KIT



## SPARE

### A027-01

Moisture tester reagent  
(one-pound tin)

## ACCESSORY

### A027-11

SPEEDY CALIBRATION KIT

A026 KIT



A028-01



## A021-10N MOISTURE, DIGITAL MICROWAVE PORTABLE METER

For an accurate, fast and easy determination of moisture content in sand, fine and coarse aggregates up to 25 mm diameter.

By using the latest microwave and microprocessor technology, and simply inserting the 5 prongs into the material to be measured, the unit displays the percentage of moisture content.

**Measuring range:** 0...20% with  $\pm 0.2\%$  accuracy.

**Frequency:** 50 MHz; USB data link; over 1000 readings storage.

**Power:** 2 AA batteries

**Weight:** 1800 g approx.

## A021 MOISTURE METER MICROLANCE

This electronic tester directly measures and visualizes on the display the moisture percentage and temperature of sand and fine aggregates up to  $\varnothing$  10 mm max by inserting the crucible tip. Suitable for both site and laboratory tests.

**Moisture range:** 0-35%, accuracy 0.5%

**Measuring deep:** 1000 mm

**Temperature range:** -20 °C to +60 °C accuracy 0.5 °C.

**Battery:** 4x1.5V AA cells

**Dimensions:** 120x120x1200 mm

**Weight:** 2 kg approx.

## A021-01 MOISTURE METER MICROLANCE

Similar to mod. A021, but with measuring deep up to 2000 mm.

**Dimensions:** 120x120x2200 mm

**Weight:** 3 kg approx.



## DESICCATORS BOROSILICATE GLASS

Complete with perforated porcelain plate.

without vacuum	with vacuum
A035 $\varnothing$ 200 mm	A039 $\varnothing$ 200 mm
A036 $\varnothing$ 250 mm	A040 $\varnothing$ 250 mm
A036-01 $\varnothing$ 300 mm	A040-01 $\varnothing$ 300 mm

## ACCESSORY

**V300-15** DESICCATORS SALTS SILICA GEL BOX 1000 g

## A029 CHAPMAN FLASK

STANDARDS: ASTM C70

AASHTO T142

Used for field determination of the amount of surface moisture in fine aggregates. Graduated to 200 ml between the two bulbs and from 375 up to 450 ml above the second bulb.

**Weight:** 500 g



## A030 REACTION CONTAINER

Standards: ASTM C289 | NF P94-048 | UNI 85209-22

UNI 8520-22

Used for the chemical determination of the potential reactivity of aggregates with alkalis in portland cement concrete. Manufactured from stainless steel and fitted with an air-tight cover. Capacity 60 ml approx.

**Weight:** 2 kg approx.



**V023-01**

## V023-01 MOISTURE DETERMINATION BALANCE

See section " V " General Equipment p. 579

## SAMPLE SPLITTERS (RIFFLE BOXES)

STANDARDS: EN 933-3 | ASTM C136, 702 | NF P18-553  
UNI 8520 | AASHTO T27, T87  
BS 812:1, 1377:2, 1924:1 | UNE 83120

Used for splitting materials such as aggregates, sand, gravel and similar into two representative portions. Painted or stainless steel made, they are supplied with two collecting pans.



A063

A062

Model	Material Steel	Slot width	Max. Size Sample mm	Slot Number	Weight kg	Spare collecting pan
A062	Stainless	1-4" - 6.3 mm	5	12	0.8	A062-02
A063	Stainless	1-2" - 12.7 mm	10	12	1.2	A063-02
A064	Painted	3-4" - 19 mm	13	12	11	A064-02
A065	"	1" - 25.4 mm	20	12	11	A065-02
A065-01	"	1 1-2" - 38 mm	25	8	11	A065-02
A065-03	"	= = - 45 mm	35	8	12	A065-04
A066	"	2" - 50.8 mm	40	8	13	A066-02
A067	"	2 1-2" - 63.5 mm	50	8	18	A067-02

A064 ... A067

## A068 LARGE CAPACITY SAMPLE SPLITTER

STANDARDS: EN 933-3 | ASTM C136 | NF P18-553 | UNI 8520  
AASHTO T27, T87 | BS 812:1, 1377:2, 1924:1  
UNE 83120

Designed for the reduction of test samples which are too large in volume to be conveniently handled. Suitable for any material from sand sizes up to Ø 108 mm. Each chute bar is 12 mm wide to get openings of 12 - 24 - 36 - 48 - 60 - 72 - 84 - 96 - 108 mm. Complete with two collecting pans. Clam shell hopper: 30 litres capacity. Very sturdily constructed, it is totally galvanized for rust protection. **Weight:** 55 kg approx.



A068

A068-05

### ACCESSORY

**A068-05** SCOOP steel made to collect aggregates. Dimensions: 700x300x100 mm. Weight: 5 kg approx.

**A068-11** WHEELS (Kit of 4) with brake for an easy displacement of the large splitter in the laboratory.



A068-11

### SPARE

**A068-01** Collecting pan for mod. A068

## BULK DENSITY AND VOIDS MEASURES

STANDARDS: EN 1097:3 | ASTM C29-97 | BS 812  
UNI 8520 :6 | ISO 6872 | CNR N. 62, 63, 64

Used to determine the loose bulk density and voids of aggregates. Stainless steel made, the 10, 20 and 50 litres models have handles.

- A069** Measure 1 litre cap.
- A069-01** Measure 5 litres cap.
- A069-02** Measure 10 litres cap.
- A069-03** Measure 20 litres cap.
- A069-04** Measure 50 litres cap.



A069-02

A069-01



## BAR (GRID) SIEVES

FOR AGGREGATE FLAKINESS INDEX AND PARTICLE SHAPE

STANDARDS: EN 933-3 | UNI 8520-18 | NF P18-561 | NLT 354

The frame is anodized aluminium made and the grids are **stainless steel rod bars having diameter from 5 to 15 mm** according to the slot widths. Sieve sizes, slot width tolerances and rod bars diameter are checked one by one, and meet EN 933-3 Standard. Each sieve is supplied complete with identification serial number label.

**Sieve dimensions:** 275x275x475 mm

**Weight:** 2 kg each sieve.



**A048N KIT**

Model	Slot width mm	Model	Slot width mm
A048-01	2.50	A048-08	12.50
A048-02	3.15	A048-09	16.00
A048-03	4.00	A048-10	20.00
A048-04	5.00	A048-11	25.00
A048-05	6.30	A048-12	31.50
A048-06	8.00	A048-13	40.00
A048-07	10.00	A048-17	50.00

**A048N KIT** COMPLETE SET of 14 bar sieves from 2.5 (A048-01) to 50 mm (A048-17) slot width.

**A048-14** BAR GRID SIEVE, slot width 9.5 mm. Used to check the wear of the spheres of the Micro-Deval having nominal size 10 mm.

### ACCESSORIES for BAR (GRID) SIEVES

**A048-20** KIT OF TWO DEVICES, anodized aluminium made, complete with stainless steel screws, to fix one bar sieve over another one, in order to get a cascade to be fitted on mechanical sieve shakers.

**A048-21** COVER for Bar Sieves, anodized aluminium made.

**A048-22** RECEIVER for Bar Sieves, anodized aluminium made, complete with coupling device to be fixed to the Matest shakers mod. A059-02 KIT | A059-03 KIT | A059-04 KIT A060-01



### A048-15 GAUGE FOR AGGREGATE FLATNESS INDEX

STANDARD: UNI 8520 part. 18

Used to determine the volume of each circumscribed sphere.

Made of heavy brass sheet.



**A048-15**

## FLAKINESS SIEVES

STANDARD: BS 812:105.1

Used to determine if aggregate is flaky; i.e. if thickness is less than 0.6 of nominal size. Manufactured from heavy steel sheet, they have dimensions as specified by Standards and are available in the following size openings:

Model	Slot width mm	Slot length mm
A049-01	4.9	30
A049-02	7.2	40
A049-03	10.2	50
A049-04	14.4	60
A049-05	19.7	80
A049-06	26.3	90
A049-07	33.9	100



**A049 KIT**

**A049 KIT**  
COMPLETE SET of n°7 flakiness sieves.  
**Weight:** 15 kg approx.

## TEST SIEVES

STANDARDS: EN 933-2 | ISO 3310-1, ISO 3310-2, ISO 565 | ASTM E 11 | BS410 | NF X11-504 | UNI 2331, UNI 2333 | DIN 4187-1 | UNE 7050

All sieves are made with stainless steel woven wire and frame and meet International Specifications.

Perforated plates are made of tinned steel, both square and round holes.

The sieves are available in the following diameters: 200 - 250 - 300 - 315 - 400 - 450 mm and 8"-12".

Their apertures are clearly marked on the label, including the serial number for the identification and traceability of the sieve.

Each sieve is supplied complete with certificate of conformity.

### HOW TO BUY WOVEN WIRE MESH SIEVES

STANDARDS: ISO 3310-1 | EN 933-2, | BS410 | UNE 7050  
DIN 4187-1 | NF X11-504 | UNI 2331, 2333  
ASTM E11

The available openings of the woven wire mesh sieves are listed in the next pages and are coded from n° 00 to 77.

The buyer has to add to this number:

**A052-...** for the frame Ø 200 mm

**A051-...** for the frame Ø 250 mm

**A053-...** for the frame Ø 300 mm

**A054-...** for the frame Ø 315 mm

**A055-...** for the frame Ø 400 mm

**A050-...** for the frame Ø 8"

**A043-...** for the frame Ø 12"



**A052-...**

**Note:** It is possible to test approx. 1000 g of material by using Ø 200 mm sieves; and 3000 g with Ø 300 mm sieves.

### HOW TO BUY PERFORATED PLATE SIEVES

#### "Square Hole"

STANDARDS: EN 933-2 | ISO 3310-2 | BS 410 | DIN 4187-1

The available openings of the perforated plate square hole sieves

are listed in the next page, and are coded from n° 01 to 37

The buyer has to add to this number:

**A031-...** for the frame Ø 200 mm

**A032-...** for the frame Ø 300 mm

**A033-...** for the frame Ø 400 mm



**A031-...**

**Note:** EN 933-2 Standard specifies that "sieves with opening 4 mm and over shall be perforated plate square hole". Below 4 mm they shall be woven wire.

### HOW TO BUY PERFORATED PLATE SIEVES

#### "Round Hole"

STANDARDS: UNI 2334

The available openings of the perforated plate round hole sieves are listed in the next page, and are coded from n° 01 to 38

The buyer has to add to this number:

**A037-...** for the frame Ø 200 mm

**A038-...** for the frame Ø 300 mm



**A037-...**

## TABLE OF THE WOVEN WIRE MESH SIEVES

STANDARDS: EN 933-2 | ISO 3310-1 | ASTM E11 | UNI 2331, UNI 2333 | UNE 7050 | BS 410 | DIN 4187-1 | NF X11-504

Aperture Size mm	ASTM Number	Frame Ø 200 mm	Frame Ø 300 mm	Aperture Size mm	ASTM Number	Frame Ø 200 mm	Frame Ø 300 mm
0.020	635	A052	A053	2.800	7	A052-40	A053-40
0.025	500	A052-00	A053-00	3.150	-	A052-41	A053-41
0.038	400	A052-01	A053-01	3.350	6	A052-42	A053-42
0.040	-	A052-02	A053-02	4.000	5	A052-43	A053-43
0.045	325	A052-03	A053-03	4.750	4	A052-44	A053-44
0.050	-	A052-04	A053-04	5.000	-	A052-45	A053-45
0.053	270	A052-05	A053-05	5.600	3,5	A052-46	A053-46
0.063	230	A052-06	A053-06	6.300	1-4"	A052-47	A053-47
0.075	200	A052-07	A053-07	6.700	0.265"	A052-48	A053-48
0.080	-	A052-08	A053-08	7.100	-	A052-49	A053-49
0.090	170	A052-09	A053-09	8.000	5-16"	A052-50	A053-50
0.100	-	A052-10	A053-10	9.500	3-8"	A052-51	A053-51
0.106	140	A052-11	A053-11	10.0	-	A052-52	A053-52
0.125	120	A052-12	A053-12	11.2	7-16"	A052-53	A053-53
0.150	100	A052-13	A053-13	12.5	1-2"	A052-54	A053-54
0.160	-	A052-14	A053-14	13.2	0.530"	A052-55	A053-55
0.180	80	A052-15	A053-15	14.0	-	A052-56	A053-56
0.200	-	A052-16	A053-16	16.0	5-8"	A052-57	A053-57
0.212	70	A052-17	A053-17	19.0	3-4"	A052-58	A053-58
0.250	60	A052-18	A053-18	20.0	-	A052-59	A053-59
0.300	50	A052-19	A053-19	22.4	7-8"	A052-60	A053-60
0.315	-	A052-20	A053-20	25.0	-	A052-61	A053-61
0.355	45	A052-22	A053-22	25.4	1"	A052-62	A053-62
0.400	-	A052-23	A053-23	26.5	1.06"	A052-63	A053-63
0.425	40	A052-24	A053-24	28.0	-	A052-64	A053-64
0.500	35	A052-25	A053-25	31.5	1 1-4"	A052-65	A053-65
0.600	30	A052-26	A053-26	37.5	1 1-2"	A052-66	A053-66
0.630	-	A052-27	A053-27	40.0	-	A052-67	A053-67
0.710	25	A052-28	A053-28	45.0	1 3-4"	A052-68	A053-68
0.800	-	A052-29	A053-29	50.0	2"	A052-69	A053-69
0.850	20	A052-30	A053-30	53.0	2.12"	A052-70	A053-70
1.000	18	A052-31	A053-31	56.0	-	A052-70S	A053-70S
1.180	16	A052-32	A053-32	63.0	2 1-2"	A052-71	A053-71
1.250	-	A052-33	A053-33	75.0	3"	A052-72	A053-72
1.400	14	A052-34	A053-34	80.0	-	A052-73	A053-73
1.600	-	A052-35	A053-35	90.0	3 1-2"	A052-74	A053-74
1.700	12	A052-36	A053-36	100.0	4"	A052-75	A053-75
2.000	10	A052-37	A053-37	106.0	4.24"	A052-76	A053-76
2.360	8	A052-38	A053-38	125.0	5"	A052-77	A053-77
2.500	-	A052-39	A053-39				

TABLE OF THE PERFORATED PLATE SIEVES, "SQUARE HOLES"

STANDARDS: ISO 3310-2 | EN 933-2 | BS 410 | DIN 4187-1

Aperture mm	Frame Ø 200 mm	Frame Ø 300 mm
4.00	A031-01	A032-01
4.75	A031-02	A032-02
5.00	A031-03	A032-03
5.60	A031-04	A032-04
6.30	A031-05	A032-05
6.70	A031-06	A032-06
7.10	A031-07	A032-07
8.00	A031-08	A032-08
9.00	A031-34	A032-34
9.50	A031-09	A032-09
10.00	A031-10	A032-10
11.20	A031-11	A032-11
12.50	A031-12	A032-12
13.20	A031-13	A032-13
14.00	A031-14	A032-14
16.00	A031-15	A032-15
18.00	A031-35	A032-35
19.00	A031-16	A032-16
20.00	A031-17	A032-17
22.40	A031-18	A032-18
25.00	A031-19	A032-19
26.50	A031-20	A032-20
28.00	A031-21	A032-21
31.50	A031-22	A032-22
37.50	A031-23	A032-23
40.00	A031-33	A032-33
45.00	A031-24	A032-24
50.00	A031-25	A032-25
53.00	A031-26	A032-26
56.00	A031-36	A032-36
63.00	A031-27	A032-27
75.00	A031-28	A032-28
80.00	A031-37	A032-37
90.00	A031-29	A032-29
100.00	A031-30	A032-30
106.00	A031-31	A032-31
125.00	A031-32	A032-32

TABLE OF THE PERFORATED PLATE SIEVES, "ROUND HOLES"

STANDARD: UNI 2334

Aperture mm	Frame Ø 200 mm	Frame Ø 300 mm
4.00	A037-01	A038-01
4.75	A037-02	A038-02
5.00	A037-03	A038-03
5.60	A037-04	A038-04
6.30	A037-05	A038-05
7.10	A037-06	A038-06
8.00	A037-07	A038-07
9.00	A037-08	A038-08
10.00	A037-09	A038-09
11.20	A037-10	A038-10
12.50	A037-11	A038-11
13.20	A037-12	A038-12
14.00	A037-13	A038-13
15.00	A037-37	A038-37
16.00	A037-14	A038-14
18.00	A037-15	A038-15
19.00	A037-16	A038-16
20.00	A037-17	A038-17
25.00	A037-18	A038-18
28.00	A037-19	A038-19
30.00	A037-38	A038-38
31.50	A037-20	A038-20
35.50	A037-21	A038-21
40.00	A037-22	A038-22
45.00	A037-23	A038-23
50.00	A037-24	A038-24
53.00	A037-25	A038-25
56.00	A037-26	A038-26
63.00	A037-27	A038-27
71.00	A037-28	A038-28
75.00	A037-29	A038-29
80.00	A037-30	A038-30
90.00	A037-31	A038-31
100.00	A037-32	A038-32
106.00	A037-33	A038-33
112.00	A037-34	A038-34
125.00	A037-35	A038-35

## WET WASHING SIEVES

Used for wet testing of fine granulated materials.  
Frame and woven wire cloth are stainless steel made.  
Frame dimensions: Ø 200 mm by 100 or 200 mm height.

### MODELS

- A045** Cloth opening 0.074 mm by 200 mm height  
**A045-02** Cloth opening 0.063 mm by 200 mm height  
**A045-05** Cloth opening 0.074 mm by 100 mm height  
**A045-06** Cloth opening 0.063 mm by 100 mm height

### MODELS for ASTM E11 Standard

- A045-07** Sieve Ø 8" by 4" height, opening 0.075 mm  
**A045-08** Sieve Ø 8" by 8" height, opening 0.075 mm

## WET SIEVING PAN+LID STAINLESS STEEL

The water enters through the spray nozzle mounted on top of the lid and spill out of the pan with the finest granulated material.  
Supplied complete with two watertight seals.

Model	Description	Set of 10 seals
<b>A046</b>	Pan + Lid, Ø 200 mm	<b>A046-11</b>
<b>A046-02</b>	Pan + Lid, Ø 8"	<b>A046-11</b>
<b>A047</b>	Pan + Lid, Ø 300 mm	<b>A047-11</b>
<b>A047-02</b>	Pan + Lid, Ø 400 mm	<b>A047-12</b>

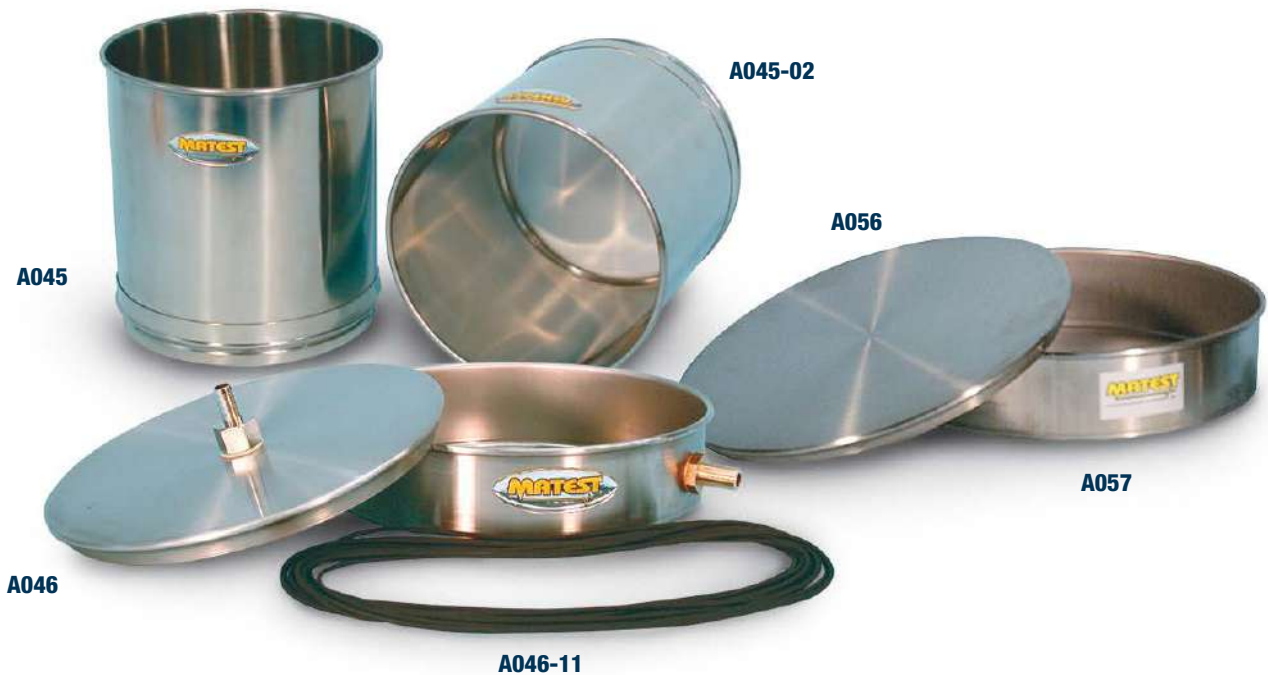

	Ø 200 mm	Ø 300 mm	Ø 250 mm	Ø 315 mm	Ø 8"	Ø 450 mm	Ø 400 mm	Ø 12"
<b>LID</b>	<b>A056</b>	<b>A056-01</b>	<b>A056-02</b>	<b>A056-03</b>	<b>A056-04</b>	<b>A056-05</b>	<b>A056-06</b>	<b>A056-07</b>
<b>RECEIVER</b>	<b>A057</b>	<b>A057-01</b>	<b>A057-02</b>	<b>A057-03</b>	<b>A057-04</b>	<b>A057-05</b>	<b>A057-06</b>	<b>A057-07</b>



- V179** Bristle brush, soft, Ø 35 mm  
**V179-02** Double ended, brass and nylon bristle  
**V179-03** Double ended soft/hard nylon  
**V179-05** Soft brush, Ø 3 mm BS 812  
**V179-06** Hard nylon sieve brush, flat 60 mm

## A104N ULTRASONIC CLEANSING BATH 10 LITRES

Used for a safe and valid cleaning of sieves and glassware, which could be damaged by ordinary cleaning methods.

It is particularly suitable for fine mesh sieves. The bath accepts sieves up to 200 mm and 8" diameter.

Supplied complete with timer 0 - 99 minutes.

Internal diameter: 260 mm, height 200 mm

Stainless steel made, with incorporated electronic generator, frequency 35 KHz.

Complete with lid and discharge cock.

**Capacity:** 7 litres

**Power supply:** 230V 50-60Hz 1ph 200W

**Dimensions:** 274x370 mm

**Weight:** 8 kg approx.



A104-01N

## A104-01N ULTRASONIC CLEANSING BATH 25 LITRES

Similar to mod. A104N but with inside dimensions: Ø 410x200 mm.

Ultrasonic frequency adjustable from 28 KHz to 40 KHz.

Water heating system, adjustable from ambient to +80 °C

It accept sieves up to 350 mm diameter.

**Capacity:** 25 litres

**Power supply:** 230V 50-60Hz 1ph 1700W

**Dimensions:** 510x510x450 mm

**Weight:** 35 kg approx.

### ACCESSORY

**A104-02** CLEANSING LIQUID for ultrasonic bath, 25 litre can.

**A104-03** CLEANSING LIQUID for ultrasonic bath, 5 litre can.



A104N

## A071-10 VOID CONTENT OF FINE AGGREGATE

STANDARDS: ASTM C1252 | AASHTO TP33



Used to determine the uncompacted void content of a fine aggregate sample. Indicates the angularity, spherically, and workability of fine aggregate in a mixture. Supplied complete.

**Dimensions:** 205x205x690 mm

**Weight:** 2 kg approx.



A071-10

## A058-05N AIR JET SIEVING MACHINE

STANDARD: EN 933-10

The Air Jet Machine is suitable for sieving powder and drying grain products in order to obtain sieving results between 5 to 4000 microns, through appropriate test sieves 200 mm diameter. Its working foundation is based on the use of air that tugs thin particles to make them pass through the sieve.

This effect is obtained with a vacuum machine that provokes a controlled decrease of pressure. It is equipped with an automatic cleaning system of the filter cartridge allowing **to perform many tests** (some tens) before being replaced.

The unit is supplied complete with aspirator device, plexiglass cover, filter cartridge, 5 collecting plastic bags, accessories.

**Power supply:** 230V 1ph 50-60Hz

**Dimensions:** 450x600x400 mm

**Weight:** 25 kg approx.

## A058-06N AIR JET SIEVING MACHINE

A version of air jet sieving machine with more basic model of aspirator device is also available, recommended for occasional usage only.

### MAIN FEATURES

- Sieving time from 0 to 99 minutes.
- Vacuum range from 0 to 65 mbar.
- Adjustable calibration function.
- Sieving results from 5 to 4000 microns.
- Automatic cleaning system.



### SPARE

**A058-14N** Filter cartridge.

**A058-15N** Plastic bags (pack of 5 pcs).

## TABLE OF THE SIEVES 200 MM DIAMETER FOR THE AIR JET SIEVING MACHINE

The frame is stainless steel made.

- Openings from 5 to 41 microns have **nylon mesh**
- Openings from 45 to 4000 microns have **stainless steel mesh**
- \*The opening of 65 microns has **nylon mesh**

The sieves include airproof rubber seal.



**A058-20...A058-96**

Model	Aperture micron	Model	Aperture micron	Model	Aperture micron	Model	Aperture micron
A058-20	5	A058-38	71	A058-65	280	A058-81	1120
A058-21	10	A058-50	75	A058-66	300	A058-82	1180
A058-22	15	A058-51	80	A058-67	315	A058-83	1250
A058-23	20	A058-52	90	A058-68	355	A058-84	1400
A058-24	25	A058-53	100	A058-69	400	A058-85	1600
A058-25	28	A058-54	106	A058-70	425	A058-86	1700
A058-26	30	A058-55	112	A058-71	450	A058-87	1800
A058-27	37	A058-56	125	A058-72	500	A058-88	2000
A058-28	41	A058-57	140	A058-73	560	A058-89	2240
A058-97	45	A058-58	150	A058-74	600	A058-90	2360
A058-30	50	A058-59	160	A058-75	630	A058-91	2500
A058-31	53	A058-60	180	A058-76	710	A058-92	2800
A058-32	56	A058-61	200	A058-77	800	A058-93	3150
A058-35	63	A058-62	212	A058-78	850	A058-94	3350
A058-36*	65	A058-63	224	A058-79	900	A058-95	3550
A058-37	70	A058-64	250	A058-80	1000	A058-96	4000



## ELECTROMAGNETIC SIEVE SHAKERS

STANDARDS: EN 932-5 | ISO 3310-1

These Sieve Shakers are activated by electromagnetic impulses and thanks to the triple vibrating action (vertical, lateral and rotational) they are recommended to perform sieving tests where high precision and performance are important, and where continual and intense uses are required. Therefore they are suggested for accurate sieving tests, on fine materials too.

These Electromagnetic Shakers are of simple and sturdy construction, they can hold up to 10 sieves and are also suitable for wet sieving tests (accessory mod. A046, A047).

**Power supply:** 230V 50Hz 1ph 450/750W

### MAIN FEATURES

Triple vibrating action:

- Vertical
- Lateral
- Rotational

Digital microprocessor control panel can adjust:

- Timer 0-999 minutes
- Vibration intensity
- Continuous or intermittent vibrating action
- Pause between vibrations (indicated for fine material sieving)
- The control panel can be wall fixed or placed on a bench



**A059-01 KIT**



**A059-02 KIT**

Model	Dimensions sieves Ø	Dimensions mm	Weight kg
A059-01 KIT	200 mm - 8"	320x380x850	40 approx.
A059-02 KIT	200 - 250 - 300 - 315 mm - 8" - 12"	380x440x1080	65 "
A059-03 KIT	200 - 250 - 300 - 315 - 350 - 400 mm - 8" - 12"	430x460x1150	80 "
A059-04 KIT	200 - 250 - 300 - 315 - 400 - 450 mm - 8" - 12" - 18"	480x500x1150	85 "

**A059-03 KIT****A059-04 KIT**

## A058 NOISE REDUCTION CABINET

For the sieve shakers A059 series and A060-01, lined internally with sound-proofing material for noise reduction in compliance with CE Directive.

**A058 + A059-03 KIT****A059-21**

### ACCESSORY

#### A059-21

KNOBS for fast clamping/release of the upper beam.  
Useful for fast vertical displacement of the beam.  
(Not usable with A059-01 KIT model)  
Pack of 2 knobs with rods.

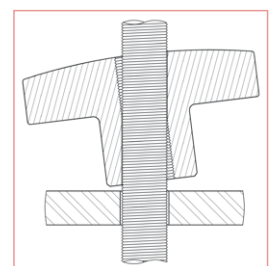
**A059-21**

## A061N HIGH CAPACITY SIEVE SHAKER

STANDARDS: EN 932-5 | ISO 3310-1

Designed for sieving considerable quantities of any material. The sieve shaker can hold six screen trays and dust pan. Supplied complete with dust pan, but **without** screen trays (to be ordered separately).

It cannot be sold in CE markets without protection (see accessories).

**Power supply:** 230V 50Hz 1ph 750W

**Dimensions:** 585x790x850 mm

**Weight:** 180 kg approx.



**A061N + A061-98**



**A061N + A061-97**



**A061N**  
with Screen Trays

### ACCESSORIES

#### A061-97

SAFETY DOORS, upper and frontal, complete with microswitch, in compliance with to CE Safety Directive.

If the door is opened while the shaker is working, it automatically stops. The doors also protect from dust.

#### A061-98

SECURITY CABINET, steel made with microswitch, complying to CE Safety Directive, lined with sound-proofing material for noise reduction. If the door is opened while the shaker is working, it automatically stops.

The cabinet also protects from dust.

Overall dimensions: 920x1000x1400 mm

#### A061-03

TRAY ONLY, without mesh, size 457x660x75 mm, suitable for mesh openings from 125 to 6.3 mm.

#### A061-05

TRAY ONLY, without mesh, size 457x660x75 mm, suitable for mesh openings from 5.6 to 1 mm.

#### A061-06

TRAY ONLY, without mesh, size 457x660x75 mm, suitable for mesh openings from 0.850 to 0.063 mm.

SCREEN TRAYS FOR SIEVE SHAKER A061N, SIZE 457X660X75 MM, ROBUST STEEL GALVANIZED FRAME. STAINLESS STEEL WOVEN WIRE MESH.  
STANDARDS: EN 933-2 | ASTM E11 | ISO 3310-1

Aperture size mm	ASTM number	Model	Aperture size mm	ASTM number	Model	Aperture size mm	ASTM number	Model
0.038	400	A061-78	0.800	-	A061-29	13.20	0.530"	A061-55
0.045	325	A061-79	0.850	20	A061-30	14.00	-	A061-56
0.053	270	A061-80	1.000	18	A061-31	16.00	5/8"	A061-57
0.063	230	A061-81	1.180	16	A061-32	19.00	3/4"	A061-58
0.075	200	A061-07	1.25	-	A061-33	20.00	-	A061-59
0.080	-	A061-08	1.400	14	A061-34	22.40	7/8"	A061-60
0.090	170	A061-09	1.600	-	A061-35	25.00	-	A061-61
0.100	-	A061-10	1.700	12	A061-36	25.40	1"	A061-62
0.106	140	A061-11	2.000	10	A061-37	26.50	1.06"	A061-63
0.125	120	A061-12	2.360	8	A061-38	28.00	-	A061-64
0.150	100	A061-13	2.500	-	A061-39	31.50	1 1/4"	A061-65
0.160	-	A061-14	2.800	7	A061-40	37.50	1 1/2"	A061-66
0.180	80	A061-15	3.150	-	A061-41	40.00	-	A061-67
0.200	-	A061-16	3.350	6	A061-42	45.00	1 3/4"	A061-68
0.212	70	A061-17	4.000	5	A061-43	50.00	2"	A061-69
0.250	60	A061-18	4.750	4	A061-44	53.00	2.12"	A061-70
0.300	50	A061-19	5.000	-	A061-45	56.00	-	A061-70S
0.315	-	A061-20	5.600	3.5	A061-46	63.00	2 1/2"	A061-71
0.320	-	A061-21	6.300	1/4"	A061-47	75.00	3"	A061-72
0.355	45	A061-22	6.700	0.265"	A061-48	80.00	-	A061-73
0.400	-	A061-23	7.100	-	A061-49	90.00	3 1/2"	A061-74
0.425	40	A061-24	8.000	5/16"	A061-50	100.0	4"	A061-75
0.500	35	A061-25	9.500	3/8"	A061-51	106.0	4.24"	A061-76
0.600	30	A061-26	10.00	-	A061-52	125.0	5"	A061-77
0.630	-	A061-27	11.20	7/16"	A061-53			
0.710	25	A061-28	12.50	1/2"	A061-54			

**A061-96** SPARE collecting pan

SCREEN TRAYS WITH PERFORATED GALVANIZED PLATE, "SQUARE HOLES"

STANDARDS: EN 933-2 | ISO 3310-2

Aperture mm	Model	Aperture mm	Model	Aperture mm	Model
4.00	A062-11	20.00	A062-30	53.00	A062-40
4.75	A062-12	22.40	A062-31	56.00	A062-41
5.00	A062-13	25.00	A062-32	63.00	A062-42
5.60	A062-14	26.50	A062-33	75.00	A062-43
6.30	A062-15	28.00	A062-34	80.00	A062-44
6.70	A062-16	31.50	A062-35	90.00	A062-45
7.10	A062-17	37.50	A062-36	100.00	A062-46
8.00	A062-18	40.00	A062-37	106.00	A062-47
9.00	A062-19	45.00	A062-38	125.00	A062-48
9.50	A062-20	50.00	A062-39		
10.00	A062-21				
11.20	A062-22				
12.50	A062-23				
13.20	A062-24				
14.00	A062-25				
16.00	A062-26				
18.00	A062-27				
19.00	A062-29				



**A061-69**

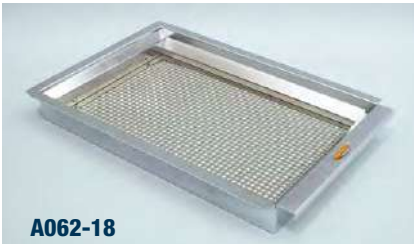

**A062-18**

## A060-01 SIEVE SHAKER MOTOR OPERATED

It accepts sieves having diameter 200 - 250 - 300 - 315 mm, and 8"...12".

This simple and low cost Sieve Shaker is activated by an electric motor and can hold up to 8 Sieves Ø 200 mm or 7 Sieves Ø 300 mm plus pan and lid.

It is also possible to perform wet sieving tests (see accessories mod. A046 and A047)

Provided of timer 0 - 60 minutes.

**Power supply:** 230V 1ph 50Hz 110W

**Dimensions:** 350x400x950 mm

**Weight:** 24 kg approx.

### CALIBRATION GLASS BEADS

Model	Ø range in mm of bead	Model	Ø range in mm of bead
A060-31	0.000 ... 0.050	A060-41	0.750 ... 1.000
A060-32	0.040 ... 0.070	A060-42	1.000 ... 1.250
A060-33	0.070 ... 0.110	A060-43	1.250 ... 1.550
A060-34	0.090 ... 0.150	A060-44	1.550 ... 1.850
A060-35	0.100 ... 0.200	A060-45	1.700 ... 2.000
A060-36	0.150 ... 0.250	A060-46	2.000 ... 2.400
A060-37	0.200 ... 0.300	A060-48	2.400 ... 2.900
A060-38	0.250 ... 0.500	A060-49	2.850 ... 3.300
A060-39	0.400 ... 0.600	A060-50	3.300 ... 3.600
A060-40	0.500 ... 0.750		

 **Note:** Cloth openings from 4 mm can be verified by using a precision vernier caliper.

## A058-01 SIEVE SHAKER HAND OPERATED FOR SIEVES Ø 200 MM AND 8"

Designed for tests on site or yard laboratory analysis when electricity is not available.

By rotating the crank, the shaker applies a vertical and rotational vibration action.

It can hold up to 6 sieves Ø 200 mm or 8" plus pan and lid.

**Dimensions:** 300x450x600 mm

**Weight:** 16 kg approx.



A058-01

### GLASS MICROSPHERES WITH NIST CERTIFICATE FOR SIEVES CALIBRATION

The calibration of the sieves or the inspection of the wear conditions of the mesh can be performed by using glass microspheres.

These models are supplied with NIST Certificate (National Institute of Standard and Technology) in pack of 5 bottles.

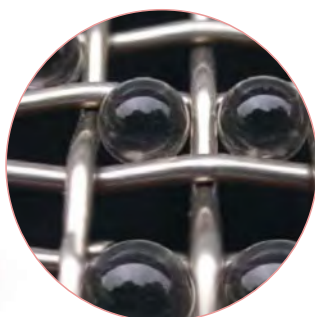

A057-31... A057-44



A060-01

Model	Sieve size (µm)	Weight per bottle (g)
A057-31	45	1
A057-32	63	1
A057-33	75	1
A057-34	90	1
A057-45	106	1
A057-35	125	1
A057-36	150	1.5
A057-37	250	2.5
A057-38	300	2.5
A057-39	425	2.5
A057-40	500	2.5
A057-41	600	2.5
A057-42	1000	7
A057-43	1180	10
A057-46	1600/1700	20
A057-44	2000	20

Other models for sieves sizes can be supplied upon request.

## A070 FLAKINESS | THICKNESS GAUGE

STANDARD: BS 812:105.1

Suitable to verify if aggregate is flaky; i.e. if its thickness is less than 0.6 of its nominal size. Constructed of heavy gauge stainless steel sheet.

**Weight:** 600 g



## A071 LENGTH GAUGE

STANDARD: BS 812:105.1

Ideal to determine if aggregate is elongated; i.e. if length is more than 1.8 of nominal size. Mounted on a hardwood base.

**Weight:** 1 kg approx.

## DETERMINATION OF THE LIGHTWEIGHT AGGREGATES CRUSHING RESISTANCE

STANDARD: EN 13055-1 method 1 and 2

### MODELS

#### A081-01 METHOD 1

Apparatus for the determination of the crushing resistance of lightweight aggregates having diameter from 4 to 22 mm, and a volumic mass over 150kg/m<sup>3</sup>. Composed of: upper and lower cylinder inside diameter 113 mm, ring with adjustable height, piston, base. Made of steel, plated against corrosion.

**Dimensions:** Ø 180 mm by 260 mm height

**Weight:** 15 kg approx.

#### A081-02 METHOD 2

Apparatus for the determination of the crushing resistance of lightweight aggregates having volumic mass lower than 150kg/m<sup>3</sup>. Composed of: upper and lower cylinder inside diameter 76 mm, piston, base. Made of steel, plated against corrosion.

**Dimensions:** Ø 100 mm by 200 mm height.

**Weight:** 6 kg approx.

**Note:** A Servoplus testing machine equipped with Servostrain (see p. 283) is needed to carry out this test.

## A072 SHAPE GAUGE - SHAPE INDEX

STANDARDS: EN 933-4, EN 933-5, EN 933-7  
DIN 4226 | CNR N.95 | NLT 354

For measuring the length/thickness ratio of individual particles.

**Weight:** 500 g

## A072-10 PROPORTIONAL CALIPER NEW

STANDARD: ASTM D4791

Used either for rapid determination of percentages of flat and elongated particles in coarse aggregate fractions of 3/8" (9.5 mm) or larger. Consisting of 8"x16" (203.2x406.4 mm) base plate with rubber feet, two fixed posts and a 12" (305 mm) pivoting arm, allowing ratios of 1:2, 1:3, 1:4, 1:5 to be obtained.

**Weight:** 3 kg approx.



## GEOMETRICAL PROPERTIES OF AGGREGATES EFFLUX INDEX OF FINE AGGREGATES

STANDARDS: EN 933-6:2014 | NF P18-564 | CNR No. 113  
ASTM C1252

## A073N EFFLUX INDEX APPARATUS NEW

Used to measure the efflux index of fine aggregates (shape and angularity). The efflux index of an aggregate is the required time in seconds of a known volume of aggregates to flow from a known opening.

The unit is basically formed by aluminium body, Ø 90 mm by 125 mm height, aluminium feed hopper Ø 100 mm by 170 mm height, control shutter, polycarbonate funnel having 85 mm height, 60° conical part, which end has Ø 12 mm, base support, valve, decanter.

**Dimensions:** 200x240x600 mm

**Weight:** 8 kg approx.



**A075N**
**LOS ANGELES ABRASION MACHINE**
**DETERMINATION OF RESISTANCE TO FRAGMENTATION**

STANDARDS: EN1097-2 | ASTM C131 | UNI 8520-19 | EN 12697-17 | EN 12697-43 | NF P18-573 | AASHTO T96 | CNR N° 34

Used to determine the resistance of aggregates to abrasion.

It comprises a heavy steel cylinder of 711 mm inside diameter x 508 mm inside length, mounted on a base frame.

The cylinder rotates at a speed of between 31 and 33 rpm.

The machine is fitted with an automatic digital counter which can be preset to the required number of revolutions of the drum.

**The cylinder is counterbalanced so that the filling opening stays in position without tilting;**
**a push-button allows to position such opening for the loading/unloading operations.**

The control panel can be wall fixed or placed on a bench.

 Supplied **without** abrasive charges which have to be ordered separately according to the requested Standards. It cannot be sold on the CE markets without its protections (see accessories).

**Power supply:** 230V 50Hz 1ph 750W

**Dimensions:** 1000x800x1000 mm

**Weight:** 370 kg approx.

**A075N**
**NEEDED ACCESSORY**
**A076-01** SET OF 12 ABRASIVE CHARGES, conforming to ASTM AASHTO | CNR | UNI | UNE | NLT Standards.

or:

**A076-02** SET OF 12 ABRASIVE CHARGES, conforming to EN | NF Standards.

**A075N + A075-12**
**UPGRADING ACCESSORIES**
**A075-11**

SECURITY CABINET, manufactured from sheet steel, conforming to CE Safety Directive.

When opening the cabinet door during Los Angeles working, a microswitch automatically stops the rotation of the drum.

**Dimensions:** 980x1070x1190 mm

**Weight:** 150 kg approx.

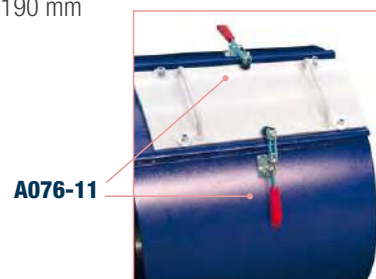
**A076-01**

**A076-11**
**A075-12**

SECURITY CABINET, manufactured from sheet steel, internally lined with sound-proofing material for noise reduction, conforming to CE Safety Directive.

When opening the cabinet's door during Los Angeles working, a microswitch automatically stops the rotation of the drum.

**Dimensions:** 980x1070x1190 mm

**Weight:** 160 kg approx.

**A076-11**

DEVICE for an easy and fast clamping of the table to the drum.

## A079 DEVAL TESTING MACHINE

STANDARDS: NF P18-577 | ASTM D2-33

Used to determine the quality of aggregates to abrasion both by dry and wet procedure. The machine essentially comprises a steel frame on which two cylinders are mounted. The machine is supplied complete with a separate control panel fitted with a digital automatic revolution counter and two collecting pans.

It cannot be sold on CE markets without security cabinet (see mod. A079-02).

**Power supply:** 230V 50Hz 1ph 750W

**Dimensions:** 1500x520x1280 mm

**Weight:** 140 kg approx.

## A079-02 DEVAL TESTING MACHINE

Same as mod. A079, but equipped with a security cabinet, manufactured from sheet steel, lined with sound-proofing material for noise reduction, conforming to CE Safety Directive.

When opening the cabinet door during Deval working, a microswitch automatically stops the machine.

**Dimensions:** 1650x650x1400 mm

**Weight:** 180 kg approx.



**A079**



**A079-02**



**A087**

**A080 KIT**

## A087 SCRATCH HARDNESS TEST APPARATUS

This device is used to determine the quantity of soft particles in coarse aggregates.

The apparatus consists of a metal sliding rod ended with a round point of 1.6 mm diameter, mounted in a suitable frame. A load of  $8.9 \pm 0.4$  N is applied to the test sample.

**Dimensions:** 160x200x350 mm

**Weight:** 8 kg approx.

## AGGREGATE IMPACT VALUE APPARATUS

STANDARDS: BS 812 | NF P18-574

Used to determine the impact value of aggregates and select them for a given application. The machine has a trip-action hammer release, blow counter device and a built-in operator safety device. Manufactured in heavy duty form with hardened steel surfaces for minimum wear. The complete assembly is cadmium plated for corrosion protection.

**Dimensions:** 445x300x880 mm

**Weight:** 60 kg approx.

THE APPARATUS IS AVAILABLE IN TWO VERSIONS:

- one meeting BS812 Standard
- one meeting NF P18-574 Standard

### A080KIT

AGGREGATE IMPACT VALUE APPARATUS. BS 812

Consisting of:

**A080-04** TEST FRAME ASSEMBLY

**A080-02** CYLINDRICAL MOULD,  $\varnothing$  102x50 mm, cylindrical measure  $\varnothing$  75x50 mm, tamping rod.

### A080-01KIT

AGGREGATE IMPACT VALUE APPARATUS. NF P18-574

Consisting of:

**A080-04** TEST FRAME ASSEMBLY

**A080-03** CYLINDRICAL MOULD,  $\varnothing$  102x52 mm.



**A077**
**MICRO-DEVAL TESTING MACHINE**
**DETERMINATION OF THE RESISTANCE TO WEAR**

STANDARDS: EN 1097-1 | EN 13450 | NF P18-572

NF P18-576 | UNE 83115 | CNR N° 109

Used to determine the resistance of aggregates to abrasion.

The machine essentially comprises a heavy steel frame on which the following stainless steel cylinders can be mounted:

4 cylinders Ø 200x154 mm, or

2 cylinders Ø 200x400 mm, or

2 cylinders Ø 200x154 mm and 1 Ø 200x400 mm

The Micro-Deval is supplied complete with separate control panel fitted with a digital automatic revolutions counter.

The control panel can be wall fixed or placed on a bench.

 Supplied **without** stainless steel cylinders and **without** stainless steel spheres which have to be ordered separately (see needed accessories).

It cannot be sold on CE markets without security cabinet (see mod. A077-01)

**Power supply:** 230V 50Hz 1ph 1100W

**Dimensions:** 1000x450x920 mm

**Weight:** 150 kg approx.

**A077 + A078-15**
**UPGRADING ACCESSORIES**
**A078-12** CYLINDER, stainless steel, Ø 200 mm x 400 mm length. Conforming to EN 13450, NF P18-572

**A078-13** SPHERES, stainless steel, Ø 30 mm  
Pack of 12 pieces. NF P18-576

**A078-14** SPHERES, stainless steel, Ø 18 mm  
Pack of 52 pieces. NF P18-576

**A078-16** CYLINDER, "HIGH PERFORMANCE", stainless steel, Ø 200 mm x 152 mm length. EN 1097-1

**A048-14** BAR GRID SIEVE, sloth width 9.5 mm. Used to check the wear of the spheres of the Micro-Deval having nominal size of 10 mm.

**A078-12**
**A078-15**

**A078-12**

**A077-01**
**MICRO-DEVAL TESTING MACHINE**

Same as mod. A077, but equipped with a security cabinet, manufactured from sheet steel, lined with sound-proofing material for noise reduction, conforming to CE Safety Directive.

When opening the cabinet's door during Micro-Deval working, a microswitch automatically stops the rotation of the cylinders.

**Dimensions:** 1150x600x1150 mm

**Weight:** 190 kg approx.

**NEEDED ACCESSORIES**
**A078-15** CYLINDER, standard, stainless steel, Ø 200 mm x 154 mm length  
(4 needed) EN 1097-1

**A078-11N** SPHERES, stainless steel, Ø 10 mm **tolerance 0.05 mm**  
 Pack of 20 kg  
EN 1097-1

**A078-11N + A048-14**

**A077-01 + A078-15**

## A078 MICRO-DEVAL APPARATUS **NEW**

STANDARDS: ASTM D6928, D7428 | AASHTO T237 | TEXAS 845-49-40 | ONTARIO LS-618

Used to determine the abrasion resistance and durability of mineral aggregates.

An aggregate sample is placed in a sealed stainless steel jar with an abrasive charge of up to 5000g of 9.5 mm diameter stainless steel balls and water, then rotated at 100 rpm for 2 hours. Percentage loss in gradation results at completion determines aggregate quality.

The machine has a sophisticated electronic controller with dedicated sensors to precisely track test time, total revolutions and rpm of jars; total revolutions are used to control test duration and jars stop within a fraction of one revolution at test termination.

Sample jars revolve protected by a polycarbonate door foreseen of safety interlocks. No moving parts are exposed to the user during test. A verification of machine performance may be given by both jar revolution and speed data.

The Micro-Deval is constituted of a sturdy steel frame which can receive 2 stainless jars together.

The jars are made of stainless steel with diameter and height according to standards (diameter within 194 and 202 mm and height within 170 and 177 mm) and are complete with cover and locking device.

An electric thermally protected motor, thanks to a mechanical transmission, supplies power to the rubber-covered rollers which move the jars.

The unit comes with 2 jars and 2 sets of abrasive charges, 5500 g.

After test completion, the worker can easily remove the abrasive charge thanks to the assistance of a magnet.

**Power supply:** 230V 1ph 50Hz 750W

(Available in 110V 60Hz with reference code: A078Y)

**Dimensions:** 570x340x1000 mm

**Weight:** 110 kg approx.



### SPARES

**A078-01** Jar with cover and locking stirrup, 5L

**A078-02** Abrasive charges, 5500 g

**A078-03** Magnet to remove abrasive charges

**A078**

### S158 KIT SAND EQUIVALENT TEST SET

STANDARDS: ASTM D2419 | AASHTO T176

This complete set comprises:

- S158-01N** Plexiglass measuring cylinder engraved at 100 and 380 mm, with transparent adhesive label, graduated in mm and inch (5 pieces)
- S158-02** Rubber stopper for cylinder (2 pieces)
- V176-02** Graduated rule 500 mm, stainless steel
- V136-01** Funnel, wide mouth
- S158-04N** Measuring can 85 ml capacity
- V121** Plastic bottle, 5 litre capacity
- S158-06** Irrigator tube with stopcock and syphon assembly
- S158-07N** Weighted foot assembly for sand level
- A052-44** Sieve, Ø 200 mm, opening 4.75 mm
- S158-09** Concentrated stock solution, 1000 ml
- V170** Stop watch, digital
- S158-11** Clamp stand set to hold the syphon assembly with bottle
- S158-12** Portable carrying case, dimensions: 550x250x400 mm

**Total Weight:** 18 kg approx.



**S158 KIT / S158-20 KIT**

### S158-20 KIT SAND EQUIVALENT TEST SET (COMPLETE)

STANDARDS: EN 933-8 | NF XP18-598 | UNI 8520-15 | UNE 83131

The set is identical to mod. S158 KIT except for:

- S158-03N** Plexiglass measuring cylinder, engraved at 100 and 380 mm.
- S158-05** Measuring can 200 ml capacity
- S158-13** Weighted foot assembly for sand level
- A052-37** Sieve Ø 200 mm, opening 2 mm
- S158-10** Irrigator tube with stopcock and syphon assembly

 **Note:** each item can be ordered separately.

### S159-01 KIT SAND EQUIVALENT TEST SET (SIMPLE)

STANDARDS: EN 933-8 | NF XP18-598 | UNI 8520-15 | UNE 83131

The set comprises:

- S158-03N** Plexiglass measuring cylinder engraved at 100 and 380 mm (4 pieces)
- S158-02** Rubber stopper for cylinder (2 pieces)
- V176-02** Graduated rule 500 mm, stainless steel
- V136-01** Funnel, wide mouth
- S158-05** Measuring can 200 ml capacity
- V121** Plastic bottle 5 litres capacity
- S158-10** Irrigator tube with stopcock and syphon assembly
- S158-13** Weighted foot assembly for sand level
- S158-09** Concentrated stock solution, 1000 ml

**Total Weight:** 5 kg approx.



**S159-01 KIT**

### S159 KIT SAND EQUIVALENT TEST SET (SIMPLE)

STANDARDS: ASTM D2419 | AASHTO T176

The set is identical to mod. S159-01 KIT except for:

- S158-01N** Plexiglass measuring cylinder, engraved at 100 and 380 mm, with transparent adhesive label, graduated in mm and inch.
- S158-04N** Measuring can 85 ml capacity
- S158-07N** Weighted foot assembly for sand level
- S158-06** Irrigator tube with stopcock and syphon assembly

#### ACCESSORIES

- S158-08** METALLIC FUNNEL, conforming to EN, NF, UNI Specifications.
- S159-11** CARRYING CASE, plastic, housing S159KIT or S159-01KIT, except the bottle V121.



**S158-08**

 **Note:** each item can be ordered separately.

## MEASURING CYLINDERS

Available Models :

### S158-01N

STANDARDS: ASTM D2419 | AASHTO T176

PLEXIGLASS MEASURING CYLINDER, engraved at 100 and 380 mm, with transparent adhesive label graduated in mm and inches.

AS ALTERNATIVE:

### S158-01GN

STANDARDS: ASTM D2419 | AASHTO T176

PLEXIGLASS MEASURING CYLINDER, engraved at 100 and 380 mm with additional **engraved scale from 0 to 380 mm**

### S158-03N

STANDARDS: EN 933-8 | NF XP18-598

PLEXIGLASS MEASURING CYLINDER, engraved at 100 and 380 mm



S158-03N S158-01GN S158-01N

## S160 N

### MOTORIZED SAND EQUIVALENT SHAKER

STANDARDS: EN 933-8 | ASTM D2419 | AASHTO T176

NF XP18-598 | UNE 83131 | CNR N.27 | UNI 8520-15

The unit provides a constant uniform shaking with automatic cycle test. Oscillating excursion is 203 mm at 175...180 adjustable strokes/min. rate. Complete with digital timer that automatically stops the shaker at the end of the test. It cannot be sold in CE markets without security cabinet (see model S160-01 N)

**Power supply:** 230V 1ph 50Hz 250W

**Dimensions:** 700x360x350 mm

**Weight:** 30 kg approx.



S160N + S158-03N + S158-02

## S161

### SAND EQUIVALENT SHAKER HAND OPERATED

STANDARDS: EN 933-8 | ASTM D2419 | NF XP18-598

AASHTO T176 | UNI 8520-15 | UNE 83131

Hand operated working through handwheel. Complete with mechanical strokes counter.

**Dimensions:** 700x350x420 mm approx.

**Weight:** 20 kg approx.



S161

## S160-01N

### MOTORIZED SAND EQUIVALENT SHAKER

Same as S160N, but equipped with steel Security Cabinet, conforming to CE Safety Directive. When opening cabinet's door during shaker working, a microswitch automatically stops the machine.



S160-01N + S158-03N + S158-02

## ASSESSMENT OF FINES

### GRADING OF FILLERS

STANDARD: EN 933-10

### A058-05N

#### AIL JET SIEVE SHAKER

Suitable for sieving powder and dry grain products up to 5 microns. Technical details: see p. 38



A058-05N

### S157 KIT BLUE METHYLENE TEST SET ASSESSMENT OF FINES AGGREGATES

STANDARDS: EN 933-9 | NF P94-068 | UNI 8520-15 | UNE 83180

Utilized to determine the clay content in the fine portions of the aggregates. The set comprises:

- S157-01** Electric stirrer adjustable from 400 to 700 rpm, complete with Ø 70 mm propeller. 230V 1ph 50Hz
- S157-06** Support base for stirrer
- S157-02** Burette 50 x 0.1 ml with stopcock
- S157-07** Support base for burette
- S157-08** Pan 200x150x80 mm
- S157-03** Filter paper Ø 90 mm (pack of 100)
- S157-04** Glass rod Ø 8x300 mm
- S157-05** 2000 ml capacity plastic beaker
- V300-28** Methylene blue, 100 g
- V300-29** Kaolinite, 500 g

**Total Weight:** 10 kg approx.

 **Note:** Each item can be ordered separately.

#### ACCESSORY

- S157-10** AUTOMATIC DISPENSER, 0-10 ml x 0.1 ml grad.  
Capacity 1000 ml  
(as an alternative to the Burette S157-02+S157-07)



**S157-10**

### S157-20 AUTOMATIC METHYLENE BLUE TESTER

This instrument determines automatically the quantity of clay in sand. It grants accurate and repeatable test results, saving a lot of time (approx. 30 minutes each test).

The apparatus is composed by: precision pump, colorimeter, control unit, filters, liquids, powder, accessories.

**Power supply:** 230V 1ph 50Hz  
**Dimensions:** 300x400x350 mm  
**Weight:** 10 kg approx.



**S157-20**

### B022T BOTTLE-ROLLER WITH VARIABLE SPEED

Suitable for mixing of liquids and, using the special jar, for grinding small specimens. Metal frame and rollers covered in rubber (second roller can be placed in various positions in order to accept different size bottles). 0,5 HP engine.

Variable roller speed: 0-95 rpm.

**Power supply:** 220V 1F 50Hz  
**Dimensions:** 640x350x140 mm  
**Weight:** 20 kg approx.



**B022T**

### B022ST BOTTLE ROLLER WITH FIX SPEED

Same model as B022T, but with fix speed of the driving roller at 73 rpm.

### B022 SP BOTTLE ROLLER

DETERMINATION OF CLAY, SILT AND DUST IN FINE AND COARSE AGGREGATES TO BS SEDIMENTATION METHOD

STANDARDS: BS 812 | ASTM C117

To rotate one up to three bottles or jars simultaneously about their longitudinal axis with rotation speed, adjustable from 0 up to 85 rpm  
Supplied complete with timer 0-99 hours

**Power supply:** 230V 50-60Hz 1ph  
**Dimensions:** 385x295x160 mm  
**Weight:** 10 kg approx.



**S132-03**

**B022 SP**

#### ACCESSORY

- S132-03** BOTTLE, pyrex glass, 1 litre capacity, with airtight stopper.

### S144 ANDREASEN PIPETTE,

25 ml capacity, glass made, used for an accurate and precise extraction of suspension material for analysis.

### S144-01 PIPETTE STAND,

to accurately raise and lower the Andreasen pipette with no transmission of vibrations.

**Weight:** 10 kg approx.



**S144**

**S144-01**

## A124 FILLER COMPACTION APPARATUS

DETERMINATION OF THE VOIDS CONTENT OF DRY COMPACTED FILLER.

STANDARDS: EN 1097-4 comparable to BS 812 | CNR N° 123 NLT 177

The apparatus consists of: cylinder with an inside diameter of 25.4 mm; plunger freely sliding into the cylinder with max. lateral play of  $0.20 \pm 0.05$  mm; four columns and metallic base holding the whole. To perform the test a measuring device (vernier caliper with 0.01 mm accuracy) is required: see accessory.

**Weight:** 4 kg approx.

### ACCESSORIES

**A124-01** FILTER PAPER Ø 25 mm (pack of 100).

**V175-03** DIGITAL VERNIER CALIPER 0 - 150 mm x 0.01 mm sens.

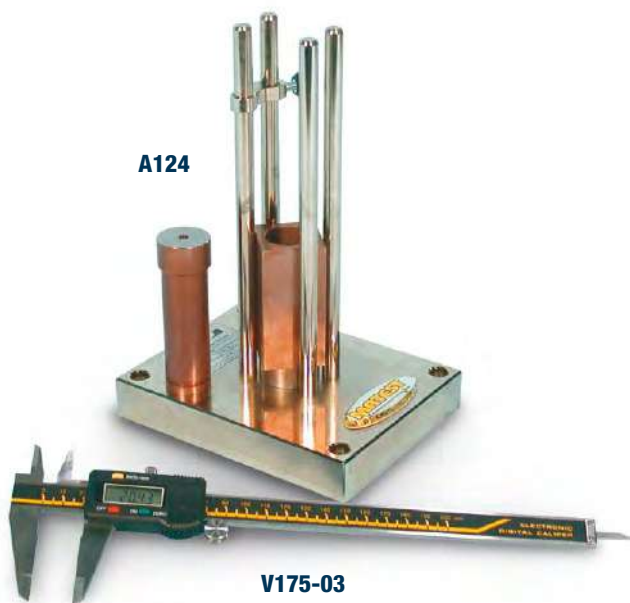

## A084 SIPHON CAN APPARATUS

STANDARD: BS 812 - part 2

Used to determine the moisture content at known conditions. Supplied complete with measuring cylinder, rubber pipes fitted with screw clips, stirring rod.

**Weight:** 5 kg approx.



## A082 AGGREGATE CRUSHING VALUE APPARATUS DIAMETER 150 MM

STANDARD: comparable to BS 812:110

Comprising 150 mm nominal diameter steel cylinder, plunger, base plate, tamping rod and measure 115 mm diameter x 180 mm deep. Used for aggregate passing 12.7 mm and retained by 9.52 mm sieve.

The complete assembly is cadmium plated for corrosion protection.

**Weight:** 20 kg approx.

## A083 AGGREGATE CRUSHING VALUE APPARATUS DIAMETER 75 MM

STANDARD: comparable to BS 812:110

Comprising 75 mm nominal diameter steel cylinder, plunger, base plate, tamping rod and measure 57 mm diameter x 90 mm deep. Used for aggregate smaller than 9.52 mm

The complete assembly is cadmium plated for corrosion protection.

**Weight:** 8 kg approx.

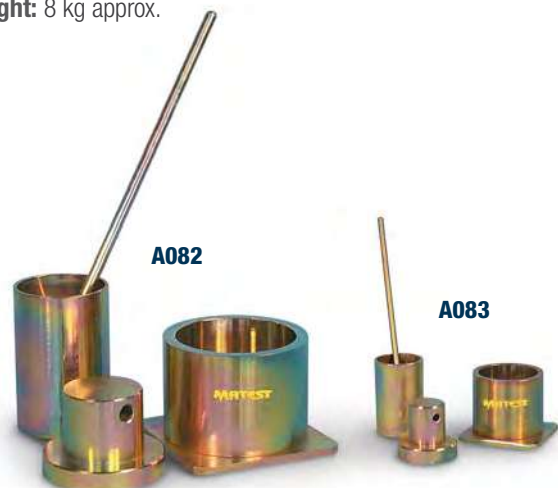

## A085 QUARTERING CANVAS (not illustrated)

STANDARD: ASTM C702 - Method B

Used in field for quartering soil and aggregates.

Size: 140x140 cm

## A086 VOLUMETER FOR AGGREGATES

STANDARD: BS 812

Used to measure coarse aggregate density through water displacement method. Formed by a cylindrical metal container Ø 150x350 mm fitted with a siphon tube at 250 mm from bottom.

**Weight:** 3 kg approx.



### ACCESSORY

**V101-04** GRADUATED GLASS CYLINDER 250 ml capacity

## DETERMINATION OF PARTICLE DENSITY AND WATER ABSORPTION OF AGGREGATES

STANDARDS: EN 12390-7 | EN 1097-6 | UNI 6394-2 | BS 812, 1881:14 | ASTM C127, C128 | AASHTO T84 | DIN 12039 | NLT 154

To perform this test, additional general purpose equipment are required, such as: oven, sieves, balances etc., and the following specific apparatus:

### V041

**DENSITY BASKET**, Ø 200 mm by 200 mm high, mesh size 3.35 mm, all stainless steel made.

Other models of density baskets listed at p. 582

### V085

**SPECIFIC GRAVITY FRAME**

Technical data: see Section "V" p. 582

### PYKNOMETER,

pyrex glass, complete with stopper, capillary tube and funnel; used to determine the voids and bulk density of aggregates.

**V103** Capacity 500 ml

**V103-01** Capacity 1000 ml

### PYKNOMETER,

pyrex glass, wide mouth Ø 50 mm, complete with capillary tube stopper, used to evaluate the volume density and voids of aggregates.

**V105-04** Capacity 500 ml

**V105-05** Capacity 1000 ml

**V105-06** Capacity 2000 ml

### S148

**SAND ABSORPTION CONE AND TAMPER**, used in determining the specific gravity and absorption of fine aggregates.

## DETERMINATION OF THE PARTICLE DENSITY OF FILLER. PYKNOMETER METHOD

STANDARDS: EN 1097-7 | NF P18-558 | BS 812

To perform this test additional general purpose equipment are required such as: oven, sieves, balance etc., and the following specific apparatus:

### SPECIFIC GRAVITY BOTTLE, GAY LUSSAC TYPE,

pyrex glass, complete with capillary tube stopper, to determine the particle density and specific gravity of filler in fine aggregates.

**V108-01** Capacity 50 ml

**V108-02** Capacity 100 ml

**V108-03** Capacity 250 ml

### E136

#### WATER BATH

Heating/circulating system, all stainless steel made. Equipped with cooling coil device for connection to water net.

Capacity: 40 litres. Digital thermostat

Temperature range: ambient to 60 °C.

Accuracy: ± 0.5 °C.

#### Inside dimensions:

510x350x230 mm

#### Overall dimensions:

680x420x420 mm

#### Power supply:

230V 50-60Hz 1ph 2000W

**Weight:** 28 kg approx.



**E136**



**V041**

**V041**

**V073-01**

**V085**



**V103**

**V105-05**

**S148**



**V108-01**

**V108-02**

## MAX. 10 MM SIZE DETERMINATION OF THE RELATIVE DENSITY AND WATER ABSORPTION OF AGGREGATES

STANDARDS:

BS 812:2, 1377:2 | ASTM D 854

AASHTO T100 | EN 1097-6

### S147

**PYKNOMETER,**

glass made, with aluminium cone and rubber seal.

Capacity: 1 kg



**S147**

## A092 LABORATORY JAWS CRUSHER

STANDARDS: ASTM C289 | UNE 83 120

Comparable to EN 933-3, EN 933-6

Designed to crush any sort of material, also the hardest. The structure is made of cast iron, the shaft of rectified steel, and the jaws of manganese.

Jaws opening is regulated from 2 to 18 mm by a wedge.

Jaw size: 100x60 mm

The crusher is suitable to prepare the material to be reduced to powder with the jar mill A091 serie.

Complete with steel cabinet conforming to CE safety Directive, separate on/off switch and collecting pan.

**Power supply:** 230V 50Hz 1ph 1100W

**Dimensions:** 400x900x1170 mm

**Weight:** 130 kg approx.

## A091-10 JAR MILL

CAPACITY 300 G | 1000 G

Designed to reduce from 5 mm to powder granulometric materials like: cement, stones, rocks, hard materials. Supplied **without** jar to be ordered separately (see needed accessory).

This mill can accept jars having capacity 300 cc. or capacity 1000 cc.

Jar is in prokorund material with relevant hard porcelain spheres.

The noise reduction steel cabinet and microswitch are conforming to CE safety Directive.

Built in timer. Rpm: about 400

**It can be used only for wet tests.**

**Power supply:** 230V 50Hz 1ph 750W

**Dimensions:** 350x710x410 mm

**Weight:** 50 kg approx.

A091-10 + A091-11



Jars Detail

### NEEDED ACCESSORY

**A091-11** JAR, 300 cc. capacity complete with spheres.

or:

**A091-12** JAR, 1000 cc. capacity, complete with spheres.

## A091-02 JAR MILL

CAPACITY 1500 CC.

Same as mod. A091-10, but with jar capacity of 1500 cc.

Supplied **complete** with jar and spheres.

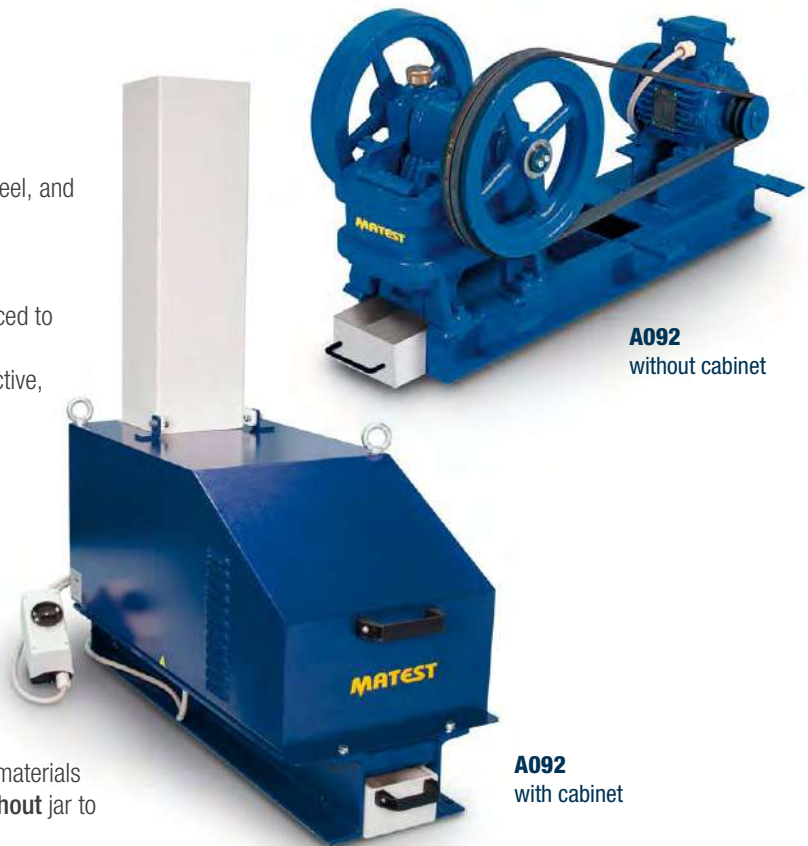

A092  
without cabinet

A092  
with cabinet

## A093 DRY MIXER

Designed to mix dry materials like: powders, cement, gypsum and granulometric materials. In a short time it assures a perfect and homogeneous mixture. The mixer consists of two opposite asymmetric cones and a pan for collecting the mixed material. Supplied complete with timer. The volume of the cone is 30 litres.

Mixing capacity: 10 kg of material

Speed rotation: 30 rpm

It cannot be sold on CE markets without security cabinet (see mod. A093-11)

**Power supply:** 230V 50Hz 1ph 750W

**Dimensions:** 700x700x1200 mm

**Weight:** 130 kg approx.

### ACCESSORY

#### A093-11

SECURITY CABINET, manufactured from sheet steel, lined with sound proofing-material for noise reduction, conforming to CE Safety Directive.

**Dimensions:**

980x1070x1190 mm

**Weight:** 100 kg approx.



A093



## A113 SKID RESISTANCE AND FRICTION TESTER

STANDARDS: EN 1097-8 | EN 1338, 1341, 1342, | EN 13036-4 | EN 1436 | BS 7976 | ASTM E303 (model A113-01)

### MAIN FEATURES

- Suitable for both site and laboratory applications.
- Perfect for measuring pavement (road asphalt) surface frictional and skid resistance properties.
- Perfect for polished stone value tests on aggregates (curved specimens) from accelerated polishing tests.
- Suitable to perform tests on:
  - Natural stones conforming to EN 1341, 1342.
  - Concrete block pavers conforming to EN 1338.
- Accurate adjustment operations through an incorporated slider lifting device.
- Simple and reliable height adjusting system.
- High-precision results thanks to an extremely light pointer.



**A113**

The tester measures the energy loss when a rubber slider edge is propelled over the surface under test. The release mechanism of the pendulum arm has an original solution reducing the friction to minimum for better accuracy.

The skid tester is supplied complete with:

- Additional incorporated scale for tests on Polished Stone Value specimens.
- Rule, made of plexiglass, for sliding length verification.
- Thermometer range  $-10$  to  $+110$  °C for surface temperature measurement.
- Stool, wash bottle, bristle and tool set for machine use.
- Carrying case.
- Calibration Certificate conforming to EN 1097-8 or ASTM E303 (model A113-01).

The tester is supplied **without** rubber sliders that have to be ordered separately (see accessories).

**Case dimensions:** 730x730x330 mm

**Weight:** 32 kg approx.

#### **Note:**

The tester is supplied calibrated to meet EN Specifications. On request the skid tester can be supplied to meet ASTM 303 Spec. (model A113-01)

### **A113-01 SKID RESISTANCE AND FRICTION TESTER**

STANDARD: ASTM E303

As above, but calibrated to meet ASTM 303 Specifications.

## ACCESSORIES

- A110-03** MOUNTED RUBBER SLIDER, TRL rubber, 76 mm width for site use (road surface), complete with conformity certificate.
- A110-01** MOUNTED RUBBER SLIDER, TRL rubber, 32 mm width for Polished Stone Value tests (laboratory), complete with conformity certificate.
- A110-05** MOUNTED RUBBER SLIDER, 4S rubber, 76 mm width (ceramics, marbles, paving tiles, sidewalk surface) complete with conformity certificate.  
**NEW** Standards: EN 13036-4 | BS 7976
- A110-11** METAL BASE PLATE for Polished Stone Value tests in laboratory, and for tests on natural stones and concrete block pavers. Supplied **without** specimen clamping devices, to be ordered separately.
- A110-12** CLAMPING DEVICE for Polished Stone Value tests in laboratory.
- A110-13** CLAMPING DEVICE for tests on natural stones (EN 1341, 1342); for concrete block pavers (EN 1338) and skidding tests on wooden floor (EN 1339).
- A110-20** PINK LAPPING FILM (10 sheets) for Skid Calibration.

**MATEST**  
BE ALWAYS IN SAFE RANGE

### SKID TESTER CALIBRATION CERTIFICATE

This certificate includes the results of the instrument test performed by the builder

Paragraph	Data detected under verification	Field of acceptability	
1	Skid Tester - Serial number - Certificate N.	A113/AB/002248	
2	Date of the test	06/03/2014	
3	Temperature range verification		
	Ambient temperature at the beginning of verification	20 °C ± 3°C	
	Ambient temperature at the end of verification	20 °C ± 3°C	
4	Distance slider tip/rotation center	510 mm ± 5 mm	
5	Height regulation width	50 mm ± 50 mm	
6	Alignment index with graduated scale		
	Alignment index error with reference on the graduated scale in the field of acceptability	OK ± 0.1 mm	
7	Pendulum mass	1505 grams ± 30g	
8	Distance gravity center of the arm	408 ± 5 mm	
9	Index weight	85 grams ± 5g	
10	Index length	300 mm ± 10 mm	
11	Index balancing	Balance	
12	Spring stress (mid slider position)	22.2 N ± 0.5 N	
13	Spring stress constancy		
	Deflection mm	Load gram	
	0	38	± 20 gram between one deflection and the other
	-1	2484	
	-2	2490	
	-3	2496	
	-4	2505	
	-5	2513	
	-6	2522	
	-7	2535	
	-8	2544	
	-9	2556	
	-10	2567	
	-11	2580	
	-11.5	2588	
14	Slider run, using the handle	10 mm ± 6.5 mm	
15	Slider run	11.5 ± 11 mm	
16	Foot fluctuation (compared to base)	OK	
17	Feet upright of the feet (compared to base)	OK	
18	Releasing device, without friction	OK	
19	Line-up index / arm	OK	
20	Simulation of index zero point	OK	
21	Slider angle (compared to horizon)	26° ± 3°	

**Matest S.p.A. - unipersonale**  
 Direzione e Coordinamento: Ferruccio Geronzi s.r.l.  
 Via delle Industrie, 25 - 20145 Treviglio (BG) Italy - Tel. +39 035 2100011 - Fax +39 035 2100225  
 E-Mail: info@matest.com - www.matest.com  
 C.F. e P.IVA: 03647010158 - R.I.A. 15616 - ZB9499 - Cap. Soc. € 1.000.000,00 i.p.

Calibration certificate to EN 1097-8



A110-11 + A110-12



A110-03

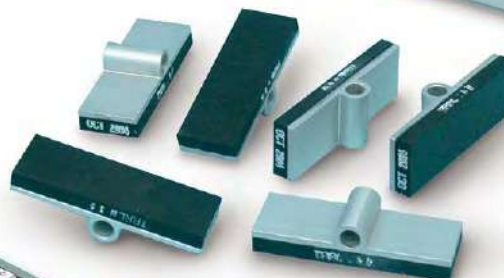

A110-01



**A128N**
**ACCELERATED POLISHING MACHINE**

## DETERMINATION OF THE POLISHED STONE VALUE

STANDARDS: EN 1097-8, EN 1341, 1342, 1343 | BS 812:114 | NF P18-575 | CNR N.105

**MAIN FEATURES**

- Up to 14 specimens simultaneously.
- Road wheel speed, from 310 to 330 RPM.
- Digital control panel for an easy test execution.
- Resultant specimens perfectly suitable for the skid resistance tester.

It measures the resistance of road aggregates, paving stones and paving blocks to the polishing action of vehicle tyres on a road surface.

The specimens are manufactured with suitable moulds and located on the Road Wheel.

The wheel is now rotated and enters in contact with solid rubber tyre, spring loaded. Abrasive charges are continuously introduced by two automatic mechanical feeders (hoppers).

The feeders are held by a suitable support disjoined from the machine body; this solution safeguards feeding calibration and reliability/life of the hoppers from the influence of test execution vibrations.

The water is supplied at a controlled rate through a water container equipped with flow regulator.

During the test execution the display shows the remaining

time and the speed rotation of the wheel holding the specimens.

Supplied complete with 2 rubber wheels (one for corn and one for flour emery), set of 4 specimen moulds and 2 mould covers, while control stone, corn and flour emery have to be ordered separately (see accessories).

**Power supply:** 230V 50Hz 1ph 750W

**Dimensions:** 1800x820x600 mm

**Weight:** 175 kg approx.

**ACCESSORIES**

**A128-02** CORN EMERY, 25 kg pack

**A128-03** FLOUR EMERY, 5 kg pack

**A128-13** FLOUR EMERY "Original", 5 kg pack

**A128-04** CONTROL STONES, ungraded, 25 kg bag, PSV 49

**A128-04N** CONTROL STONES, ungraded, 5 kg bag, PSV 50-60

**A128-05** FRICTION TESTER REFERENCE STONE (Criggion Stone), ungraded, 25 kg bag.

**A049-02** FLAKINESS SIEVE, slot 7.2 by 40 mm, used to retain the road aggregates.

**SPARES**

**A128-11** Mould (without cover) to prepare the specimen.

**A128-12** Cover for the mould.

**A128N**
**C129**
**ABRASION BÖHME TESTER**

 STANDARDS: EN 1338:2004 | EN 1339, 1340, 13892-3  
 EN 14157 | EN 13748-2 | DIN 52108

Used to measure volume loss in a specimen under abrasion stress in tests, such as:

- Paving stones
- Concrete slabs
- Slabs made of natural rocks
- Natural stone slabs

See section "C" Concrete pag. 324

**C129**

## A111N ABRASION MACHINE

### AGGREGATE ABRASION VALUE (AAV) DETERMINATION

STANDARDS: EN 1097-8 | Comparable to BS 812-113

The test measures the resistance of aggregates to surface wear by abrasion. Inadequate abrasion of road-surfacing aggregates leads to an early loss of the texture depth required to keep high-speed skidding resistance.

The machine consists of a heavy duty mainframe on adjustable feet, steel lap wheel 615 mm diameter, which rotates in a horizontal plane at 28/31 r.p.m., precision machined steel shaft and sealed bearings, resilient mounted electric gearmotor, scraper blades for sand removal, revolution counter.

The control panel can be wall fixed or placed on a bench.

Supplied complete with two specimen moulds, two trays, weights and fixing device.

**Power supply:** 230V 1ph 50-60Hz

**Dimensions:** 1130x710x1100 mm

**Weight:** 200 kg approx.



**A111N**

## ACCESSORIES

**A111-11** GRADED SILICA SAND. Pack of 25 kg.

**V179-05** SOFT HAIR BRUSH Ø 3 mm BS 812

## SPARE

**A111-12**

Two specimen moulds.



**A111-12**

## A112 ABRASION TESTER FOR NATURAL STONES AND CONCRETE

### ABRASION RESISTANCE OF NATURAL STONES AND CONCRETE TILES FOR PAVING

STANDARDS: EN 1338, 1339, 1340, 1341, 1342, 1343 | EN 14157  
CEN ISO-TC 178 | UNI 10532 | BS 6717:2001

Used to determine the resistance to abrasion and wear of concrete products and natural stones, by measuring the length of a groove produced on the specimen surface through a disc with thickness of 70 mm that rotates at controlled speed and makes a constant pressure on the specimen. A charge of abrasive material must be interposed between the disc and the specimen. The instrument is supplied with an electronic speed controller and shutting off device after the set number of revolutions, 1 kg of abrasive material, a calibration plate comparable to boulonnais marble, accessories and cabinet conforming to CE Safety Directive.

**Power supply:** 230V 50-60Hz 1ph 500W

**Dimensions:** 450x420x800 mm

**Weight:** 85 kg approx.



**A112-05**

**A112 ... A112-10**

## A112-10 ABRASION TESTER FOR BRICKS AND TILES

STANDARDS: EN 102 | EN 12808-2 | EN 1344, 10545-6, 14617-4  
CEN ISO-TC 178 | ISO 10545-6 | UNE 127024

Same as mod. A112 but with disc thickness of 10 mm.

Suitable for bricks and ceramic glazed tiles.

## A112-11 CONVERSION KIT

Used to convert the abrasion tester mod. A112 into mod. A112-10. It comprises abrasion disc Ø 200 mm x 10 mm thick, counter weight and hopper.

## SPARES

**A112-01** Abrasive white corundum sand 80 grade. Pack of 5 kg.

**A112-05** Calibration plate comparable to boulonnais marble.

**A105**
**CALCIMETER, (GASOMETER) DIETRICH-FRÜHLING**  
 CARBONATE CONTENT OF AGGREGATES

Used for the determination of calcium carbonate ( $\text{CaCO}_3$ ) in certain products such as limestone and lime marl. It mainly consists of a glass container in which the reaction between the calcium carbonate present in the product and a solution of hydrochloric acid takes place.

The gased product is collected and measured by a device connected to the container.

As the volume of the produced gas ( $\text{CO}_2$ ) is in relation to the  $\text{CaCO}_3$  amount contained in the material, it is possible to calculate the percentage of  $\text{CaCO}_3$

**Dimensions:** 400x200x1100 mm

**Weight:** 13 kg approx.

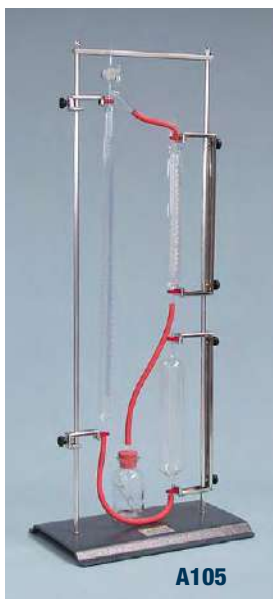
**A105**

**C279-02**
**A117 + A116-11 + A116-12**
**A117**
**END-OVER-END SHAKER**

STANDARDS: EN 1997-2 | BS 1377:2

Used to determine the specific gravity of soils, it rotates two gas jars at approx. 50 rpm to satisfy BS Standard.

The shaker is equipped with an original friction device conforming the unit to CE Safety Directive.

Supplied **without** gas jars to be ordered separately

**Power supply:** 230V 50Hz 1ph 150W

**Dimensions:** 550x430x500 mm

**Weight:** 20 kg approx.

**ACCESSORIES**
**A116-11**

GAS JAR to determine the specific gravity of soils.

Complete with glass cover.

Diameter 75 mm by 300 mm height

Weight: 1.3 kg

**A116-12**

RUBBER BUNG for the gas jar A116-11

**C279-02**

SEPARATE CONTROL PANEL,

complete with ON/OFF switch, timer, fuse, electric protections.

**A116-11**
**A116-12**
**A108**
**CRUSHING COEFFICIENT MACHINE**

STANDARD: CNR N°4

Composed of a metallic guide 500 mm long and 140 mm wide, suitable to contain 500 gr. of testing aggregates.

The guide is slided lengthwise and transversalwise through handwheels.

In the center of the table a metallic wheel of 400 kg weight with band of 50 mm wide is placed.

The test is performed by passing the wheel on the aggregates contained into the guide for twelve times.

**Dimensions:**

1200x500x1850 mm

**Weight:** 640 kg approx.

**A108**
**S132N**
**COLOUR STANDARD GLASS SCALE**

STANDARDS: ASTM C40-11 Method D | AASHTO T21 | UNI 8020-14

For the determination of organic impurities in soils and fine aggregates. Chart with 5 glass reference scales.

**S132-03**
**S132-01**
**S132-02**
**S132N**

**S132-01** Graduated impurities test bottle, stopper, pyrex glass, 500 ml - ASTM C40

**S132-02** Graduated impurities test bottle, stopper, pyrex glass, 500 ml, marked at 130 and 200 ml - UNI 8020-14

**S132-03** Graduated impurities test bottle, stopper, pyrex glass, 1000 ml - ASTM C40

**V300-24** Sodium Hydroxide, pack of 1000 g

## TESTS FOR THERMAL AND WEATHERING PROPERTIES OF AGGREGATES

### DETERMINATION OF RESISTANCE TO FREEZING AND THAWING

STANDARDS: EN 1367-1 | EN 932-5

It provides the needed informations on aggregates subject to freeze and thaw test cycles.

The cold stress on aggregates depends on the water saturation degree and the freeze percentage. The test can be performed on aggregates having dimensions from 4 to 63 mm.

**A103-10** CONTAINER, stainless steel made, having nominal capacity of 2000 ml.  
Supplied complete with stainless steel cover.

**Weight:** 600 g approx.

**A103-11** BALLAST for the test container, plated steel made, used for tests on lightweight aggregates.

**Weight:** 2 kg approx.

**Note:** To perform the test sieves with different openings according to the dimensions of the aggregates are also requested.

### MAGNESIUM SULPHATE TEST

Tests for thermal and weathering properties of aggregates.

STANDARDS: EN 1367-2, also comparable to ASTM C88  
UNE 7136 | UNI 8520-10



**A103** BASKET, stainless steel mesh, Ø 120 mm x 160 mm high, 3.35 mm opening

**A103-01** BASKET, stainless steel mesh, Ø 95 mm x 120 mm high, 1.18 mm opening

**A103-02** BASKET, stainless steel mesh, Ø 95 mm x 120 mm high, 0.600 mm opening

**A103-03** BASKET, stainless steel mesh, Ø 65 mm x 80 mm high, 0.150 mm opening

**V172-05** HYDROMETER, calibrated at 20 °C, range 1200 – 1300 g/ml, accuracy 0.001 g/ml

**V125-03** CONTAINER, tinned steel with airtight lid, Ø 200 mm x 200 mm high.



### DETERMINATION OF THE BEHAVIOUR AND RESISTANCE TO FREEZING AND THAWING OF AGGREGATES

STANDARDS: EN 1367-1 | CNR N° 80 | UNI 8520-20  
BS 812:124 | ASTM C671, C682

#### C316N CLIMATIC CHAMBER, 535 LITRES CAPACITY

Temperature range -30 +70 °C.  
Technical details and other models described in section Aggregates p. 26 or Concrete p. 348



#### C348T \* ROCK AND MASONRY SAW

It accepts blades up to Ø 400 mm.  
Useful cutting height: 130 mm

#### ACCESSORIES:

**C350-14**  
DIAMOND BLADE Ø 400 mm

**C352**  
DEVICE to clamp cylinders and cores

**C353**  
DEVICE to clamp irregular shaped specimens



**Note:** Technical details and other saw models described in Section "C" Concrete p. 358

## DETERMINATION OF DRYING SHRINKAGE TESTS OF THERMAL AND WEATHERING PROPERTIES

STANDARDS: EN 1367-4 | BS 812:102

### A107

**PRISM MOULD** 50x50x200 mm, three gangs, complete with steel inserts, to determine the thermal properties and the weathering of aggregates in drying shrinkage of concrete.

The test is developed on concretes of fixed mix proportions and aggregates of 20 mm max. size.

**Weight:** 8 kg approx.



### SPARE

**A107-11** Inserts for A107 mould. Pack of 12 pieces

## DETERMINATION OF POTENTIAL REACTIVITY OF ALKALI IN AGGREGATES FOR USE IN CONCRETE

STANDARD: UNI 11604



### A101N

**PRISM MOULD ONE GANG**, 75x75x285 mm, complete with inserts and handles to determine the dimensional variations of the specimen.

Steel made, Vickers hardness HV 400 approx.

**Weight:** 3 kg approx.

### A101-01N

**PRISM MOULD**, same as A101N but **two gangs**, complete with inserts.

**Weight:** 5 kg approx.

### A101-05N

**CONTAINER**, stainless steel made, complete with specimen holder.

**Weight:** 5 kg approx.



### ACCESSORIES

**A101-03N** REFERENCE ROD 295 mm long UNI 11604.

**A101-11N** SPARE STEEL INSERTS. Pack of 12 pieces.

**E087-06** TAMPER, hard wood made, to compact the specimen.

## DETERMINATION OF POTENTIAL REACTIVITY OF ALKALI IN AGGREGATES FOR USE IN CONCRETE

STANDARD: UNI 8520-22

### A101

**PRISM MOULD**, 25x25x280 mm, three gangs, complete with six steel inserts to determine the dimensional variations of the specimen.

Steel made, Vickers hardness HV 400 approx.

**Dimensions:** 120x300x35 mm

**Weight:** 4.5 kg approx.



### E078 KIT

**LENGTH COMPARATOR** with digital dial indicator mod. S382-01, 12 mm travel by 0.001 mm divisions, complete with battery and RS232 connection to PC.

For more details and other models: see p. 397

**S382-13** CABLE to connect S382-01 and S383 to PC through USB port for direct visualization and recording of the measurement.

**E078-01** Reference rod for A101 mould (UNI 8520-22)

**E078-06** Reference rod for A107 mould (UNI EN 1367-4)



### E067-05

**MORTAR BAR CONTAINER**

STANDARD: ASTM C227

Technical details: see p. 399

## DETERMINATION OF RESISTANCE TO THERMAL SHOCK

**A023-01N**

### MUFFLE FURNACE 1100 °C HIGH CAPACITY

STANDARD: EN 1367-5

Used for the determination of resistance to thermal shock of aggregates subject to heating and drying, in the production of hot bituminous mixtures.

The test is applied to heated and soaked aggregates at 700 °C for 180 seconds, and comparing the strength loss and loss in fines, obtained as per EN 1097-2 Spec. before and after the heating test. The furnace is also suitable for general purpose laboratory tests  
Technical data: see p. 25

**Power supply:** 400V 3ph 50-60Hz 6Kw

#### ACCESSORIES

**A107-20** TEST PLATE, metal, 440x240x4 mm with 12 mm rim

**A107-21** SUPPORT FRAME, for metal test plate.

**A107-22** PLATE, fire proof, 445x250x10 mm

**A107-23** FABRIC, stainless steel, size 445x250 mm, 2 mm cloth aperture



**A023-01N**

## A115 MOHS HARDNESS SCALE SET

STANDARD: EN 101

Used for determining the hardness of the surface of the materials. Composed by a case containing 9 minerals of the Moh's hardness scale, copper strip, small glass and magnet bar.

**Weight:** 500 g



**A115**

## INDEX OF VELOCITY OF ROCKS:

Ultrasonic pulse velocity tester. See section "C" concrete mod. C369N...C372N p. 371...372



**C372N**

**A122**

## BARTON COMB (PROFILOMETER) 300 MM LENGTH

Used for the evaluation of the surface roughness of rock samples. This simple device allows very thin steel wires to perfectly lay to the outline of the sample under test, in order to allow its analysis.

**Dimensions:** 300x120 mm

**Weight:** 1 kg approx.



**A122**

**A122-01**

## BARTON COMB (PROFILOMETER) 150 MM LENGTH

Same as mod. A122 but 150 mm long.



**A122-01**

**A109**

## ABRASIMETER

STANDARDS: EN 154 | EN ISO 10545-7

Suitable to determine the abrasion resistance of glazed tiles and other materials.

The instrument has three stations, and it can work either with wet (PEI) or dry (MCC) abrasive charges.

Eccentricity is 22.5 mm

Revolutions per minute are 300

Complete with cabinet conforming to CE Safety Directive.

**Power supply:** 230V 50-60Hz 1ph 300W

**Dimensions:** 400x700x500 mm

**Weight:** 38 kg approx.



**A109**



**A132**

**A132-01**

**A132**

**GEOLOGICAL HAMMER**, pointed tip, for preliminary rock identification. **Weight:** 600 g approx

**A132-01**

**GEOLOGICAL HAMMER**, chisel edge, for preliminary rock identification. **Weight:** 600 g approx



## A125N DIGITAL POINT LOAD TESTER 56 kN (ROCK STRENGTH INDEX)

STANDARDS: ASTM D5731 | ISRM

### MAIN FEATURES

- High precision electric load cell.
- Capacity 56 kN.
- Core specimens up to 4" (101.6 mm).
- Easy reading of the distance between the conical points thanks to a graduated scale.

Used to determine the strength values of a rock specimen both in the field and in the laboratory.

It consists of a load frame for applying loads, on which a manual hydraulic jack is mounted.

The applied load is measured by a high precision electric load cell with a digital display unit range 0-56 kN proving:

- 65.000 divisions      ■ 0.001 kN resolution
- Linearity: 0.05%      ■ Hysteresis: 0.03%
- Repeatability: 0.02%

The strength index (IS) is got by the formula  $P : D^2$  where P is the strength and D the space between the two conical points. Supplied complete with wooden carrying case, goggles, accessories.

**Dimensions:** 400x530x720 mm    **Weight:** 25 kg approx.



A125N

A125-02

## A126 DIGITAL POINT LOAD TESTER 100 kN NEW (ROCK STRENGTH INDEX)

Capacity: 100 kN

Same as mod. A125N, but having load capacity up to 100 kN.

### ACCESSORY for A125N and A126

**A125-02** LOWER AND UPPER PLATE with seat ball to modify the Point Load Tester into a portable compression tester (see section "C" concrete, mod. C094) p. 323

### SPARE

**A125-01** Set of two hardened conical points.



C390

## A095 POLISHER - GRINDER

Used for the preparation of rock and metallurgical specimens from lapping to final polishing. The disc is 200 mm diameter and the rotation speed is 300 rpm.

The machine is supplied complete with bakelite working disc and set of 25 abrasive silicon carbide discs.

**Power supply:** 230V 50 Hz 1ph 200W

**Dimensions:** 370x500x300 mm

**Weight:** 31 kg approx.



A095

### SPARE

**A095-01** Abrasive silicon carbide disc.  
Pack of 25.

## C381 ROCK CLASSIFICATION HAMMER LOW IMPACT ENERGY MODEL

STANDARDS: ASTM D5873 | ISRM

This impact hammer is used for rock classification test. The core rock specimen normally NX 54.7 mm diameter is held on a special cradle (accessory) in horizontal position, and the hammer tests the same in all its length, to obtain an average of the readings.

**Impact energy:** 0.74 Nm

**Measuring range:** 10...60 N/mm<sup>2</sup>

**Weight:** 2 kg



C381

A121

### ACCESSORIES

**A121** **ROCK CRADLE STANDARD:** ASTM D5873  
To locate EX to NX core rock specimens during the classification tests by the Rock Hammer mod. C381. **Weight:** 20 kg

**C390** **CALIBRATION ANVIL**  
STANDARDS: EN 12504-2 | ASTM D5873, C805  
Used for periodical obligatory verification of the test hammers, as specified by EN Standards.  
Technical data: see Section "C" Concrete p. 368  
**Dimensions:** Ø 150x230 mm. **Weight:** 16 kg

## C299 AUTOMATIC SPECIMEN GRINDING MACHINE

STANDARDS: EN 12390-2 | ASTM D4543

Designed to grind and polish cubic and cylindrical specimens of concrete, rocks, natural stones etc. having 380 mm. as max height. The specimens are fixed to the table by proper bolts, ensuring perfect coupling and blocking. The revolving abrasive head is radially and alternatively moved in both direction through an electric motor actuated by a push button.

The vertical movement of the grinding head has an accuracy of 0.05 mm.

The grinding machine is supplied complete with a collecting and water decantation tank, a motorpump, a large protection waterproof carter, eight abrasive charges. Supplied **without** locking stirrups and diamond grinding sectors to be ordered separately (see accessories).

**Working base surface:** 775x280 mm

**Grinding wheel:** Ø 330 mm

**Vertical span width:** min. 95 mm max. 380 mm

**Power supply:** 400V 3ph 50Hz 4500W

**Dimensions:** 1220x1080x1730 mm

**Weight:** 410 kg approx.



C299

### ACCESSORY

**C300-02** DIAMOND GRINDING SECTOR (required quantity: 8 pieces), "particularly recommended" because of their long duration and good grinding action.

Additional accessories listed in Section "C" Concrete p. 352

## C300-08 CORE FACE PREPARATION DEVICE

Used in conjunction with the Grinding Machine, it prepares parallel and flat core faces of rock samples. The device accepts up to 4 core samples from 20 to 55 mm diameter and can be mounted on most grinding machines.

**Weight:** 7 kg approx.



C300-08

## A130 SLAKE DURABILITY APPARATUS

STANDARD: ASTM D4644

This equipment has been developed to assess the durability of rock to weakening and disintegration when subjected to the simulated effects of climatic slaking.

The rock samples are dried and then submitted to wear stress inside a drum which is rotated into water.

The test is performed different times and the wear is given by the loss in weight of the sample.

The system incorporates a motor drive unit mounted on a baseplate which revolves two (or up to four) stainless steel drums manufactured from 2 mm mesh, 140 mm diameter x 100 mm long.

The tanks are filled with water to a level 20 mm below the drum axis. A digital timer automatically stops the motor after the preset time.

The equipment is supplied complete with two drums with tanks, and it can accept two additional drums (see accessory).

**Power supply:** 230V 1ph 50Hz 250W

**Dimensions:** 350x740x300 mm approx.

**Weight:** 30 kg approx.



A130

### ACCESSORY

**A130-11** MESH DRUM, complete with tank, base and accessories, to be connected to A130 unit.



A130-11

## C377 MICRO-CORING EQUIPMENT

STANDARD: UNI 10766

Extract a micro-core samples from a rock is an extremely valid non-destructive method, as it allows analysis and accurate evaluations (compression resistance, ecc.) without causing any damages, considering the dimension of the hole that can be eventually clogged with mortar.

Micro-coring system is ulteriorly valid and reliable if combined with ultrasonic tester and concrete hammer.

Micro-core extraction is easy, correct and requires the presence of one operator only.

The equipment comprises:

- Suitable electric drill. 230V 1F 50Hz
- Flanged guide assembly
- Drilling mask
- Impregnated diamond bit for cores with  $\varnothing$  28x100 mm
- Impregnated diamond bit for cores with  $\varnothing$  28x200 mm
- 2 Self-blocking pincers to fit the flanged guide assembly to the surface

Set of accessories comprising: anchors, bits, wrenches and screws. Carrying case.

**Dimensions:** 550x400x200 mm approx

**Weight:** 10 kg approx



### ACCESSORIES

- C377-01** WATER TANK WITH FOOT PUMP, that leaves the hands of the operators free for coring

AS ALTERNATIVE:

- C377-02** AIR-WATER PRESSURE TANK, 10 litres capacity



## C377-05 TRIMMING/CUT-OFF MACHINE FOR CORES

Suitable to cut and trim cores to be prepared for compression tests, where the flatness of both surfaces is a basic condition to obtain correct results.

The equipment is made of stainless steel and aluminum and it is supplied complete with diamond blade diameter 180 mm.

For this purpose it must be used the drill mod. C377-10 (enclosed into micro-coring equipment) and the water tank with foot pump mod. C377-01.



**C377-05**

### Note:

The maximum values expected for compression tests on micro-cores are usually lower than 60 kN. Portable compression machine mod. C094 (see p. 323), or a cement compression tester (see p. 422) may be conveniently used.

Trimming of cores may be even obtained with the grinding machine mod. C298 + device mod. C300-08 (see p. 65)

### SPARES

- C377-10** Electric drill, suitable for the microcoring purposes.  
**C377-15** Diamond bit,  $\varnothing$  28x100 mm  
**C377-16** Diamond bit,  $\varnothing$  28x200 mm



**A122-10  
TILT TEST**

**A122-10**

The instrument measures the roughness coefficient of a rock specimen or of a joint. The sample is usually a rock core cut in half lengthwise, or a core placed on another two.

The unit is also designed to test the possible fluage tendency of bituminous mixtures covering a slope of a dam subject to high sun radiations. The fluage tendency is the permanent viscous deformation of a material. The apparatus consists of an inclined adjustable plane on which the sample is placed.

Inclination angle: 0 - 75°

Max. sample diameter: 100 mm

The plane is slowly tilted until sliding of the upper surface of specimen on the lower one occurs. The roughness index can be evaluated from the measured inclination angle.

**Dimensions:** 270x175x265 mm

**Weight:** 5 kg approx.

## A129 ROCK SHEAR BOX APPARATUS

STANDARDS: ASTM D5607\* | ISRM

Used to determine the strength and slope stability of rock size max 115x125 mm or cores max. diameter 102 mm, both in the field and in the laboratory.

Complete with two horizontal rams for shear in two directions, vertical loading ram, two bourdon tube load gauges diameter 150 mm with quick release couplings, calibrated 50 kN x 1 kN division, two hand pumps with hydraulic connections and dial gauge 25x0.01 mm.

**Dimensions:** 600x250x460 mm

**Weight:** 46 kg approx.

### ACCESSORY

#### A129-03\*

SET OF 4 DIAL GAUGES 10 mm stroke x 0.002 mm division, complete with supports for vertical displacement measure, conforming to ASTM D5607 Standard.



A129



A129-01



A129-03



A129-02



A131 + A131-01

## A131 ROCK SHEAR BOX APPARATUS CYBER-PLUS 8 EVOLUTION ACQUISITION SYSTEM

STANDARDS: ASTM D5607\* | ISRM

Same mechanical design as basic model A129, but equipped with:  
n° 2 Pressure transducers for load acquisition, connected to the pumps.

n° 1 Linear displacement transducer for shear measurement.

**C405-15N** Cyber-Plus 8 Evolution "Touch-Screen" for data acquisition, visualization, processing and storing, directly connected to PC or printer.  
Technical details: see p. 377

**S224-21N** Software for test data processing.

**Weight:** 50 kg approx.

### ACCESSORY

#### A131-01\*

SET OF 4 LINEAR DISPLACEMENT TRANSDUCERS, complete with supports, for vertical displacement measure, conforming to ASTM D5607 Standard.

### ACCESSORIES for A129 and A131

**A129-01** MOULD FORMER, to prepare the specimen in the dimensions and geometry as requested by the shear box.

**A129-02** PRESSURE MAINTAINER, complete with pump, to absorb volume changes of the specimen and to allow a constant load to be maintained during the test.

**A129-04** BRITISH GYPSUM CRYSTACAL PLASTER, for casting specimens into mould assembly, 25 kg bag.

## A150N ELASTIC MODULUS OF ROCK SPECIMENS IN UNIAXIAL AND TRIAXIAL TESTS

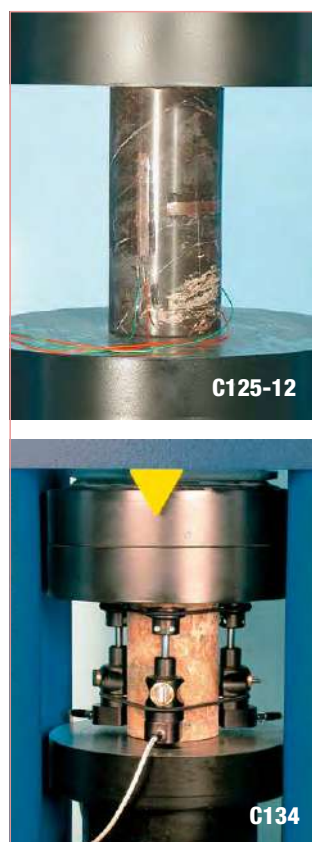

### AUTOMATIC SYSTEM WITH PACE RATE CONTROL ALSO WHEN RELEASING THE LOAD

STANDARDS: EN 14580 | EN 1926 | ASTM D7012 | ASTM D2664 | ASTM D3148 | ASTM D5407 | ISRM

It can be used with a MATEST high stability frame with capacity of 2000 or 3000 kN coupled to the Automatic Servo-controlled system "Servo-Plus Evolution" (mod. C104N).

The appliance includes:

#### ■ Hydraulic system

It is an hydraulic installation and has a high performance valve directly controlled by the digital unit that grants the automatic control of the pace rate increasing the load, keeps a certain load and then controls the pace rate decreasing the load.

The setting of the pace rate is regulated by a very sensitive valve controlled by a step by step motor that allows a micrometric action on the pace rate granting excellent results in the control of the load.

A laser position detector allows a rapid positioning of the piston and a very accurate touch point. This grants a touching sensitivity of test starting of about 0.1 per thousand of the maximum capacity. When used in conjunction with the C104NLP (see p. 70) for the application of the side pressure, the hydraulic system permits to maintain the pre-load level with extremely high accuracy.

#### ■ Electronic measuring system

The high performance control and data processing unit controlled by a 32 bit microprocessor can manage up to 8 high resolution channels for the control of load cells or transducers with strain gages bridge.

The unit contains two Analogical/Digital last generation converters with 24 bits resolution. The system processes the signals coming from the load cells and from the extensometers giving all the results required for a further processing following the most updated standards for this application.

#### ■ Data acquisition and processing software UTM2 (Universal Testing machine 2) with License for Elastic Modulus on Rocks

The software has been developed on the working line of the already known software UTM-2 (windows menu). It contains the profiles of the main Standards used, but the user can modify and personalise the test profile, which will be effected in a completely automatic way by the testing machine.

The user must enter data concerning the specimen that will be tested and the kind of test that he wants to make: shape of the specimen (cylinder-cube-block), dimensions, age of the specimen, average expected breaking value, etc. The appliance allows verifying the proper reading of the extensometers and, if everything is within the expected tolerances, it manages the average deformation value read by the transducers and processed by the digital unit, than it transmits all tests data through a serial communication port RJ45 (Network Connection) to a Personal Computer, that can already belong to the end user or be supplied separately (not included with the Software).

This data will be processed by the software and transformed in a graph load/deformation and load/time, following the specific Standards.

The software gives the possibility to print on a standard printer a test certificate reporting all data and graphs concerning the test and the specimen. The software includes the license "Servonet" mod. C123N. The extensometers (proposed in two versions: **A** and **B**) are not included in the supply and must be ordered separately (see accessories).

## ACCESSORY

### A150-01N

STANDARDS: UNI 6556 | ASTM C469 | ISO 6784 | DIN 1048

SOFTWARE to make Secant Compression Elastic Modulus tests on concrete

#### Note:

The Elastic Modulus of Rocks mod. A150N must be used together with:

A) Extensometers (strain gages), single use, electric (obliged model to perform tests with Hoek cells), available in different sizes, or:

B) Extensometers/Compressometers, electronic, universal, mechanical frame,

which are not included in the standard supply and must be ordered separately (see accessories)

## ACCESSORIES

A) ELECTRIC SINGLE USE EXTENSOMETERS, pack of 10 pieces

## AVAILABLE MODELS

**C125-10** Electric extensometer, base length 10 mm.

**C125-11** Electric extensometer, base length 20 mm.

**C125-12** Electric extensometer, base length 30 mm.

**C125-13** Electric extensometer, base length 60 mm.

**C125-14** Electric extensometer, base length 120 mm.



### C125-15

KIT for the application of single use extensometers composed by: glue, welder, solder, cleaning liquid, accessories, the whole in carrying case

### C125-09

INTERFACE MODULE, "needed accessory" to connect up to 4 electric single use extensometers. This module allows also the automatic calibration of the zero and of the measuring range after a special thermal compensation. This grants a five times better accuracy than the one requested by the Standards.



AS AN ALTERNATIVE:

### B) C134

EXTENSOMETER / COMPRESSOMETER, electronic, universal, mechanical frame.

Technical details: see p. 286



### C134-10

TEMPLATE, to regulate and calibrate the base length of the C134 extensometer

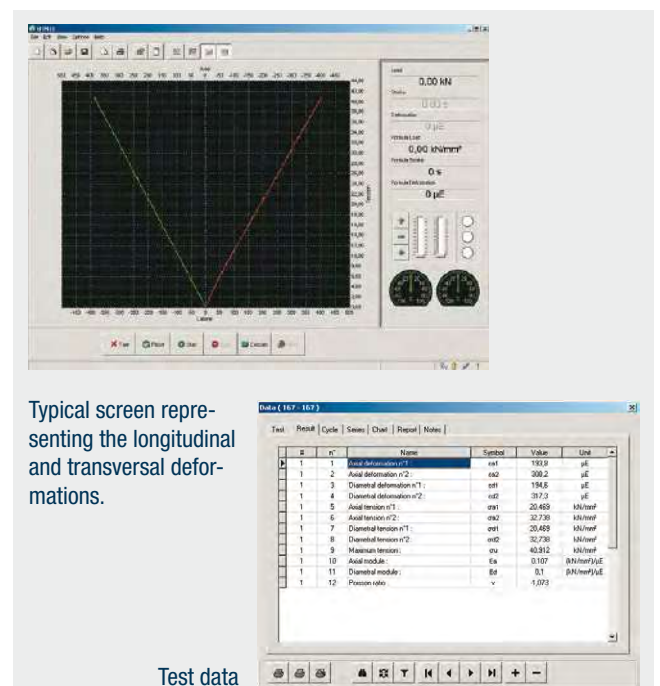

## TRIAXIAL TESTS ON ROCK SPECIMENS

STANDARDS: EN 1926, EN 14580 | ASTM D7012 | ASTM D2664 | ASTM D3148 | ASTM D5407

### MAIN FEATURES

- Axial load and constant isotropic pressure, from 5 to 6 Mpa.
- Real time reading of:
  - poisson value
  - stress value
  - max. or breaking value.
- Specimen breaking between 5 and 10 minutes.



The triaxial test is made on a rock specimen placed into a container (Hoek cell), closed into a latex membrane .

The electric extensometers are directly applied on the surface of the rock specimen and they are used for the automatic reading in real time of the different parameters and find different information such as:



- Radial deformation combined with the axial deformation to obtain the Poisson value.
- Stress value in relation with the axial and radial deformation.
- The maximum or breaking value.
- Tangent and secant Young's modulus measured on the axial deformation curve.
- Maximum stress value in triaxial conditions.

Standards require that during the compression test the load on the rock specimen is applied in a continue way in order to obtain the breaking of the specimen within a time included between 5 and 10 minutes, with a constant increase of the load included between 0.5 and 10 Mpa/second.



For this reason it is recommended the use of a compression load frame with capacity of 1500, 2000 or 3000 kN (see concrete sector) combined with the automatic servo-controlled system "Servo-Plus Evolution", model C104N, and with the automatic system for the Elastic Modulus on rocks model A150N, that includes the data acquisition and processing software.

The side pressure set by the user, is kept constant between  $\pm 1\%$  using:

### C104MLPP

Automatic servo-controlled system "Servo-Plus Progress" that grants a setting of the pressure up to 70 MPa. C104MLPP gives the possibility to perform a multi-stage triaxial test (multiple failure states test) manually. This is an excellent alternative to a series of single-stage triaxial test, necessary to determine the engineering material parameters of rocks. One multi-stage triaxial test may give the complete failure envelope. This is very important especially with a limited number of specimens or limited testing time or the budget for testing program.

## HOEK CELLS FOR ROCK TRIAXIAL TESTS

The basic Hoek cell consists of the following parts:  
Cell body complete with two screwed end caps and two self-sealing couplings, two spherical seats and pistons, hardened and ground, one specimen jacket.

### MAIN FEATURES

- Perfect with pressure up to 70 MPa.
- Suitable for specimens from 30.10 to 63.5
- Used to measure the strength of cylindrical rock specimens which are subjected to triaxial compression.



Models	Specimen Ø x height	Size	Load spreader pads (pair)	Spare spherical seat + piston	Spare Jacket	Core drilling barrel 200 mm long	Adaptors set for extruder
<b>A135</b> <span style="color: red; font-weight: bold;">NEW</span>	63.5x127 mm	HQ	<b>A136-01</b>	<b>A135-02</b>	<b>A135-03</b>	<b>A135-04</b>	<b>A141-05</b>
<b>A136</b>	30.10x60 mm	AX	<b>A136-01</b>	<b>A136-02</b>	<b>A136-03</b>	<b>A136-04</b>	<b>A141-01</b>
<b>A137</b>	38.10x75 mm	1,5"	<b>A136-01</b>	<b>A137-02</b>	<b>A137-03</b>	<b>A137-04</b>	<b>A141-02</b>
<b>A138</b>	42.04x85 mm	BX	<b>A136-01</b>	<b>A138-02</b>	<b>A138-03</b>	<b>A138-04</b>	<b>A141-03</b>
<b>A139</b>	54.74x100 mm	NX	<b>A136-01</b>	<b>A139-02</b>	<b>A139-03</b>	<b>A139-04</b>	<b>A141-04</b>

**Note:** The load spreaders A136-01 are used to avoid the cell's pistons engrave the platens of the compression machine.  
One set of extruder adaptors is formed by back plate, tamper and cell body support.

## A147 COMPRESSION DEVICE FOR ROCK CORES

STANDARD: ASTM D2938

Used to perform compression tests on rock core specimens having max. diameter 55 mm and height between 95 and 110 mm.

The loading piston is sustained by two springs; the upper compression platen is fitted with a spherical seat; the lower platen is fitted to the base.

Maximum load capacity: 100 kN

Piston's stroke: 20 mm - Platens diameter: 55 mm

Vertical daylight: max. 112 mm, min. 92 mm

Platens hardness: 60 HRC

**Overall dimensions:** Ø 151 by height 249 mm

**Weight:** 10 kg approx.

**A147**



## A140-01 CORING MACHINE

Used in the laboratory to obtain cores from irregular rock samples. To be used with the Core Drilling Barrels (accessory A136-04... A139-04).

The 2 speed electric motor 1140/2040 rpm at free load and 730/1340 rpm at max load, is equipped with friction device and double safe isolation to CE Directive.

Complete with specimen's clamp device, water cooling system and water tank.

**Power supply:** 230V 50-60Hz 1ph 1800W

**Weight:** 60 kg approx.

**A138-04**

**A137-04**

**A140-01**

**A141N**

## A141N EXTRUDER

Used to eject the rock sample from the rubber jacket, avoiding to empty the confining fluid.

Supplied without adaptors to be ordered separately (see table).

**Weight:** 12 kg approx.

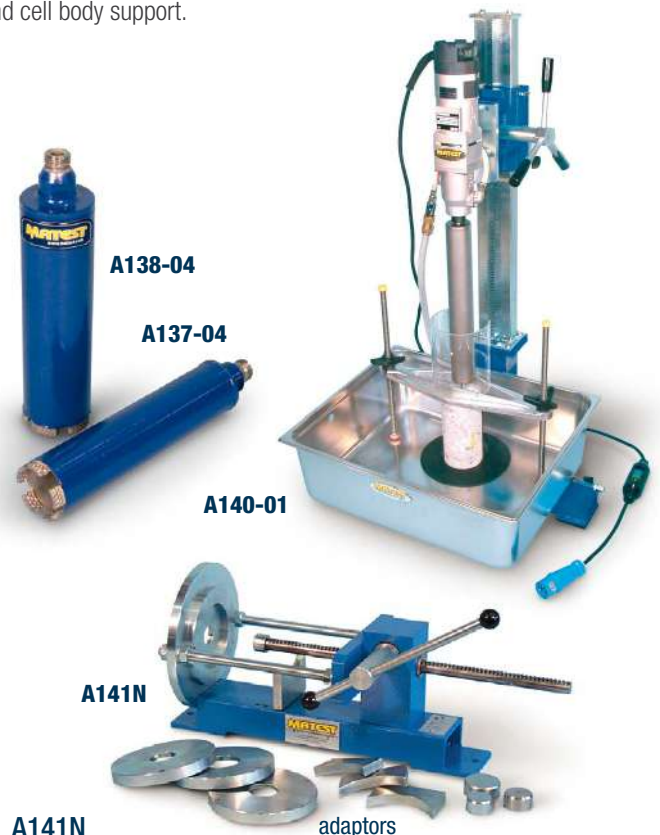



## A142N HYDRAULIC CONSTANT ISOTROPIC CELL PRESSURE SYSTEM

The unit consists of a hand operated pump, complete with precision pressure gauge supplying pressures up to 35 MPa, complete with reservoir and connections, providing all round pressure source to the Hoek Cell.

**Weight:** 18 kg approx.

### ACCESSORY

#### A129-02

PRESSURE MAINTAINER, complete with pump, to allow a constant load to be maintained during the test.

#### A144

## PERMEABILITY CONSTANT OIL/WATER PRESSURE SYSTEM

Providing an infinitely variable constant pressure from 0 to 3500 kPa. To be used with the Hoek Cell equipped with Permeability End Caps and Permeability Attachment.

The system consists of a motor hydraulic pump, oil/water vessel, piston/spring device, 10 litres of viscosity oil.

The unit is supplied complete with precision pressure gauge 0 - 3500 kPa range.

**Power supply:** 230V 50Hz 1ph

**Weight:** 20 kg approx.

#### S275

## PERMEABILITY ATTACHMENT

Mounted on tripod, to be connected to the End Cap of the Hoek Cell. Burette 50 ml capacity and 0.1 ml div.

### ACCESSORY

**S325** NYLON OPAQUE TUBING. Pack of 25 m



**A142N + A129-02**



**A138-05**

**A137-05**

## PERMEABILITY OF ROCK WITH HOEK CELLS

To measure the permeability or flow of water through a rock specimen with a controlled water pressure system.

The Hoek Cells can be equipped with the (optional) End Caps, screwed to the body.

The set consists of the upper and lower End Cap, complete with distance block.

### MODELS

- A135-05** Specimen Ø 63.5 mm ➤ NEW
- A136-05** Specimen Ø 30.10 mm
- A137-05** Specimen Ø 38.10 mm
- A138-05** Specimen Ø 42.04 mm
- A139-05** Specimen Ø 54.74 mm



**A144**

**S275**

**A137-05**

**A137**

# OUR CLIENTS ARE OUR BEST ADVERTISEMENT.



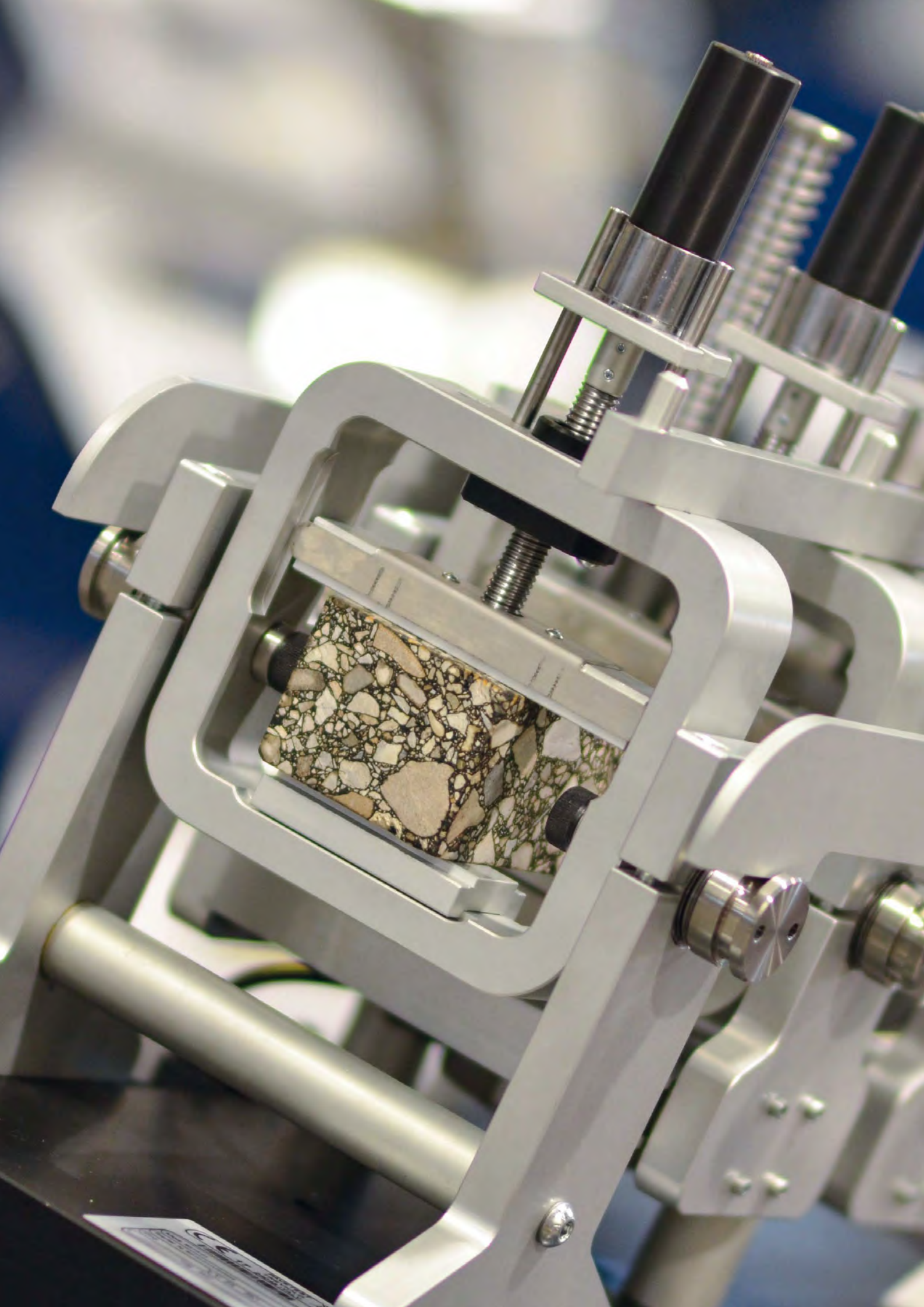

# SECTION B

## ASPHALT | BITUMEN | PAVETEST



Bituminous mixture, also known as asphalt mixture, is mainly composed by aggregates and bitumen, an infinite variety of mixtures being possible. This section is divided into three parts and shows the whole range of equipment for analyzing each component of the bituminous mixture.

**ASPHALT.** The first part is dedicated to the asphalt testing machines used to provide a solution for the whole “asphaltic path”: mixing, compacting, modelling and testing. The equipment meets the needs of those who want to perform quality control or experimentation of new asphalt mixtures.

**BITUMEN.** This section shows equipment required for bitumen testing: these include machines to study the rheological properties of bitumen as well as the features of bituminous emulsion. The last part of this section provides better solutions to perform field tests on road surface.

**PAVETEST.** Pavetest’s range of pavement dynamic testing systems both complements and completes Matest’s Asphalt and Bitumen business unit. All our products comply with the principal international standards.



**B003**
**AMA**
**ASPHALT MIX ANALYZER**

AUTOMATIC CLOSED-LOOP SYSTEM

STANDARDS: ASTM D8159 | EN 12697-1

The Asphalt Mix Analyzer (AMA) is an innovative device capable of combining all the processes associated with bitumen extraction and recovery.

The unit has been designed for the purpose of determining the bitumen content in asphalt mixture and it is the best solution to analyse and characterize the properties of the reclaimed asphalt pavement (RAP).

Through the use of solvent selectable from perchloroethylene or trichloroethylene or methylene chloride\*, the final result of the process is the separation of aggregates and filler from bitumen in order to verify the quality of the recovered granular materials and determine the mineral skeleton of the mixture. On the other hand, the bitumen can be separated from the remaining solvent solution by rotary evaporation in order to make the binder available for further analysis such as DSR, DTT and BBR according to Performance Grade and conventional bitumen tests such as penetration, ductility, softening point among others.

**Note\*:** The unit is supplied without the solvent that has to be purchased independently.

**MAIN FEATURES**

- “All in one” automatic cycle.
- Fast analysis reducing extraction costs and time.
- Combination of ultrasonic impulses and heating effect to a complete bitumen extraction.
- Complete extraction in less than 50 minutes (depending from the material tested).
- Complete close cycle avoiding toxic fumes for healthy environment.
- Automatic solvent distillation during extraction.
- Integrated 7' colour touch-screen controller.
- Customizable cycle: selectable pre-wash phase, number of washing and drying cycles.
- Optional direct connection with rotary evaporation apparatus.
- Optional integrated balance for automatic determination of the bitumen content.



Mesh drum into the washing chamber



Cup into the centrifuge, up to 8000 revolutions per minute



Integrated balance for automatic weight record



Fully automatic and closed cycle

Sturdy frame and small footprint

**B003**

The unit consists in a **stainless-steel washing chamber** where the user introduces the asphalt sample up to 3.5 kg. Subsequently, thanks to an accurate centrifugation process, the filler is separated and collected into the centrifuge cup while the bitumen solution is drained off to the solvent recovery chamber. Most of the solvent is recovered by condensation and it can be used for other extractions. The remaining part of the bitumen solution can be collected in an extraction flask after distillation, available for further analysis.

In order to perform this cycle, the unit is equipped with a **multi-layer mash washing drum** available with different openings (0.063, 0.075, and 0.090) to contain the aggregates, a **centrifuge cup** to collect the recovered filler and an extraction flask to collect the remaining bitumen solution.

Before starting washing, the unit allows to add a pre-wash phase in order to improve the process of separation and extraction of bitumen.

### TECHNICAL SPECIFICATION

- Maximum sample weight: 3.5 kg
- Centrifuge rotation speed: 8000 r.p.m.
- Scale: 10 kg, 0.1 g res.
- Cup dimensions: Ø120 mm x 200 mm height
- Extraction time: Less than 1 hour depending on the mix tested (including drying time)
- Solvent per extraction reused for several tests

**Power supply:** 380V 50Hz 3Ph

**Dimensions:** 1400x750x1500 mm approx.

**Weight:** 240 kg approx.



**B003-03**



**B003-07**



**B003-06**



**B008-11**

The unit presents a **7" colour touch-screen controller** with front panel user interface with easy to use step-thru operation. The user-friendly software allows the operator to set up:

- number and duration of the prewash cycles;
- number and duration of the washing cycles;
- number and duration of the drying cycles.

The asphalt mix analyzer can incorporate an optional balance into the worktop, for an easier weighting process at each phase.

The machine **automatically determines the bitumen content** through a guided procedure in accordance with the standards.

The door is locked during all test phases to provide a safe environment. Furthermore, the test stops automatically in case of anomalies or malfunctions, showing the type of alarm on the display in real time.

The solvent mode extraction has to be selected before supplying the unit, and the machine will be calibrated accordingly.

### NEEDED ACCESSORIES

**B003-01** Perchloroethylene operation mode

or

**B003-02** Trichloroethylene operation mode

or

**B003-21** Methylene chloride operation mode

**B003-03** Washing drum, mesh with opening 0.063 mm

or

**B003-04** Washing drum, mesh with opening 0.075 mm

or

**B003-05** Washing drum, mesh with opening 0.090 mm

**B003-06** Closing lid for washing drums

**B003-07** Centrifuge cup, Ø120 mm, up to 200 g of filler

or

**B003-22** Centrifuge cup, Ø120 mm, up to 300 g of filler

**B008-11** Lining paper for centrifuge cup. Pack of 100

### RECOMMENDED ACCESSORIES

**B003-12** Testing device for recycled tetrachloroethene analysis

**B003-13** Worktop balance for an easy and automatic determination of the bitumen content, 10 kg

**B003-14** Solvent stabilizer, for recycled tetrachloroethene

**B003-15** Solvent pumping device for safe solvent filling

**B003-16** Water cooling system high end

**B003-17** Device for the extraction of the centrifuge cup

**B003-18** Fast connection for rotary evaporator flask, for bitumen solution sampling

**B003-19** Water cooling system

**B003-20** External balance, 15 kg

## B008 AUTOMATIC BINDER EXTRACTION UNIT

STANDARDS: EN 12697-1 | ASTM D2172

Used to perform reliable analysis on bituminous mixtures utilizing the perchloroethylene (PCE) or tetrachloroethylene solvent which is classified: R40 (not cancer producing\*), for quantitative determination of binder or bitumen contained in pavement samples and hot mixed mixtures.

The system performs in only one complete automatic cycle:

- the washing, disaggregation and separation of the bituminous mixture;
- the separation of the filler from the solution formed by solvent, bitumen and filler;
- the recovery and distillation of solvent material allowing a further utilization.

The unit comprises:

- An electromagnetic sieving unit, insuring high quality double vibrating action (vertical/rotational), with solvent spraying cover for washing and disaggregation of the sample.
- A continuous flow filterless centrifuge having rotation speed of 11000 rpm equipped with a stainless steel beaker Ø 120 mm, filler capacity approx. 400 g.
- A solvent recovery unit having reclaiming capacity of 50 l/h, equipped with cooling system switching ON and OFF the unit to automatically perform the test.
- A separate control panel allows to program all these functions in a fully automatic system. It is also possible to select the manual control.

This unit is supplied complete with:

- Two stainless steel beakers Ø 120 mm
- Four stainless steel sieves Ø 200 mm openings: 0.063 - 0.250 - 0.800 - 2 mm
- Sieve Frame only Ø 200 mm to improve the capacity of the first sieve.
- Set of O ring gaskets for sieves.

**Power supply:** 400V 3ph 50Hz 5.5kW

**Overall dimensions:** 1400x680x1820 mm

**Total weight:** 185 kg approx.

**Note:** \* it is possible to use also the Trichloroethylene (CHC1:CC12), but as per 2001/59/CE Directive, it is classified "R45", and therefore considered a dangerous solvent. (Toxic and cancer-producing)

### SPARES

- B008-01** Beaker, Ø 120 mm, stainless steel AISI 304 made, with solution heat-treatment
- B008-02** Sieve Ø 200 mm water seal with O ring gasket (when ordering please specify mesh opening).
- B008-05** Sieve frame only, Ø 200 mm
- B008-06** Seal rings, for the Sieves. Pack of 10 pieces.

### ACCESSORY

- B008-11** LINING PAPER for centrifuge cup.  
Dimensions: 370x200 mm. Pack of 100 pcs.

### MAIN FEATURES

- "All in one" automatic cycle.
- Fast analysis reducing extraction costs and time.
- Complete extraction in approx 25 minutes (3500 g mixture per extraction).



**B008**

## B008-10 CABINET WITH ASPIRATOR

It allows housing the automatic bitumen extraction unit, to minimize the diffusion of vapours and toxic solvents in the laboratory.

The structure is anodized aluminium made and safety glass walls.

The unit is supplied with 4 front doors, aspirator centrifugal electric vapour, and appropriate filter group to activated charcoal.

A room with internal height at least 3 m is required.

**Power supply:** 380V 3ph 1100W

**Overall dimensions:** 1950x980x2630 mm

**Weight:** 140 kg approx.

**Note:** It cannot be sold in CE markets



**B008-10**

## B005N BITUMEN CONTENT FURNACE BY IGNITION METHOD

STANDARDS: AASHTO T308-10 | ASTM D6307-10 | BS EN 12697-39:2012



**B005N**

The binder content of bituminous mixtures is one of the major properties related to pavement performance. In particular, it affects the pavement's tendency to permanent deformation, fatigue life and susceptibility to moisture damage. Therefore, the measurement of this property is fundamentally important for **quality control (QC), quality assurance (QA) and research purposes**. In this context the ignition method can determine the binder content with high precision, offering a valid alternative to the solvent extraction methods.

Matest apparatus combines a sophisticated furnace and weighing system to continuously measure weight loss during combustion. It then **automatically calculates binder content at the end of the test**. Moreover, the method can be used for evaluation of mixture composition because the remaining aggregate can be used for determining aggregate gradation and density.

The unit presents a **7" colour Touch screen controller** with front panel user interface and easy to use step-thru operation. The user-friendly software allows the operator to set up the test with the possibility of introducing data of the mix design for a greater accuracy of the results.

Considering the high temperatures involved (the furnace may reach a temperature of 750° C) the apparatus is equipped with suitable safety systems to ensure that the furnace door is kept closed during the test and that the heating elements are deactivated any time the door is opened. Analysis can be made on a sample weighing maximum 5 kg and most tests are completed in 20 to 45 minutes. Average test times are from 20 mins (for 6 mm aggregates), to 45 mins (for 40 mm aggregates).

### MAIN FEATURES

- Fully automatic and customizable test cycle, real-time display of test parameters and results
- Possibility of introducing data of the mix design for a greater accuracy of the results up to 0.11%
- Ignition method reduces testing time and costs.
- 7" touch-screen display with smart interface.
- Integral balance measures loss on ignition to 0.1 g resolution.
- Rapid heating of main chamber with robust Ø 1 mm wire elements
- Integral fan-assisted high-temperature afterburner greatly reduces emissions
- Direct access to the scale to facilitate inspection and maintenance
- Unlimited memory storage with: 2 USB ports, 1 SD card slot, RS232/485 serial port
- On-board graphic printer

An independently controlled afterburner with exhaust fan and vent reduces emissions so low that no aspiration hood is needed.

The machine is supplied complete with 2 sample baskets with stands, hot sample safety guard, sample basket loading handle, printer paper rolls, calibration plate and protective mask. Gloves to be ordered separately.

**Outer dimensions:** 635x825x1214 mm

**Inner dimensions:** 350x445x260 mm

**Power supply:** 400V 3ph 50/60Hz 8500W

**Max Temperature:** 750 °C

**Weight:** 70 kg approx.

### TECHNICAL SPECIFICATIONS

- Samples weight up to 5000g
- Precise weight measurements displayed to 0.1 g resolution
- Test duration of 20-45 minutes
- Scale: 15,000 g capacity, 0.1 g res., ±0.1 g repeatability
- Closed-loop PID thermo-regulation
- Afterburner temperature is controlled independently from the main chamber
- Failsafe door interlock keeps the door locked during a test
- No need for filters

### ACCESSORY

**B005-10** METAL STAND to hold the furnace.



**B011**  
**ROTAREX**  
**CENTRIFUGE EXTRACTOR**

1500 / 3000 g CAPACITY

 STANDARDS: EN 12697-1 | ASTM D2172 | AASHTO T164A  
 Used for the determination of bitumen percentage in bituminous mixtures.

It consists of a removable, precision machined aluminium rotor bowl, placed into a cylindrical aluminium box.

The separate control panel incorporates an electronic card fitted with AC drive which automatically drives the bowl speed rotation ramp from 0 to 3600 rpm as requested by Standards, with fast stop bowl rotation at the end of the test.

Supplied complete with speed regulator and digital display monitoring the frequency.

 The centrifuge is supplied **without** aluminium bowl+cover and **without** filter discs to be ordered separately (see accessories)

The unit cannot be sold in CE markets (see mod. B011-10)

**Power supply:** 230V 1ph 50-60Hz 600W

**Dimensions:** 480x330x530 mm

**Weight:** 50 kg approx.

**B010T**  
**CENTRIFUGE EXTRACTOR EXPLOSION PROOF**

1500 G CAPACITY

 STANDARDS: ASTM D2172 | AASHTO T164 | CNR 38 | EN 12697-1  
 EN 12697-2

This instrument uses non-flammable trichloroethylene for the cold extraction of bitumen so that its percentage can be calculated.

It consists of a rotating bowl protected by a removable cover, a steel structure and a variable speed driving unit (electric induction motor, 3000 rpm). Capacity of bowl: 1500 g of mixture. The centrifuge's electronic control unit, which has an automatic braking system, is housed in a separate case and safety device.

**The motor is flameproof.**

Supplied with 100 filter papers.

**Power supply:** 220V, 50Hz, 1pH, 400W

**Dimensions:** 450x410x590(h) mm

**Weight:** 50 kg approx.

**B011**
**NEEDED ACCESSORIES**
**B010-11** BOWL AND COVER 1500 g capacity.  
 Made of precision machined cast aluminium.  
 Weight: 3.6 kg

**B010-15** FILTER DISC, 1500 g capacity. Pack of 100 pieces.

or:

**B010-12** BOWL AND COVER 3000 G. CAPACITY.  
 Made of precision machined cast aluminium.  
 Weight: 4.6 kg

**B010-16** FILTER DISC, 3000 g capacity. Pack of 100 pieces.

**B010T**
**NEW**

**UPGRADING OPTION**
**B011-10**  
 SAFETY ELECTROMAGNETIC MICRO-SWITCH SYSTEM to prevent the opening of the cover when the Centrifuge is working, or during the bowl rotation. Conforming to CE Safety Directive. Not applicable to the Centrifuge explosion proof version mod. B010T.

**B011-10**

## B014 CONTINUOUS FLOW FILTERLESS CENTRIFUGE

STANDARDS: EN 12697-1 | ASTM D1856

Designed for quick filterless separation of filler from binder solution or other mixtures containing sediments (cement, soil, clay), in suspension. The solution is poured into the top funnel and falls into the rotating test container with  $\varnothing$  70x200 mm. Because of the centrifugal effect, the liquid rises vertically leaving the filler and mineral particles inside the beaker. The centrifuge is supplied complete with aluminium beaker, two sieves 2 mm and 0.063 mm mesh respectively. The rotation speed is 11500 rpm, with automatic ramp and preset speed control.

Extraction capacity is up to 100 g of filler per test.

**Power supply:** 230V 1ph 50Hz 600W

**Dimensions:** 350x600x720 mm

**Weight:** 60 kg approx.

### MAIN FEATURES

- Filler recovery with filterless system.
- Continuous flow at 11500 rpm.
- Automatic speed ramp.
- Highest accuracy thanks to no dispersion of material.



B014-01

B014

### SPARE

**B014-01** Aluminium beaker  $\varnothing$  70x200 mm high.

## B021 SOLVENT RECOVERY STILL - 10 LITRE/HOUR

This unit, is provided with two tanks: one for the clean solvent and one for the dirty solvent and of a water coolant system which only needs to be connected to a tap. A safety cut out is also supplied, being activated when the solvent level becomes too low or once the process is completed.

Fully stainless steel very high quality (AISI 316) made.

Supplied complete with funnel/tank with sieve insert and 10 m plastic tube.

**Power supply:** 230V 1ph 50-60Hz 1300W

**Dimensions:** 320x400x650 mm

**Weight:** 17 kg approx.

### MAIN FEATURES

- Efficient and compact unit.
- Easy to install and totally self-contained.
- All high quality stainless steel (AISI 316) made with copper coils.
- Security devices stopping the unit at the end of the test or in case of overheatings.



B021



B079N

CABINET with aspirator to exhaust vapours and toxic solvents.

See p. 147

**B016-10**  
**HOT EXTRACTOR SET**  
 PAPER FILTER METHOD

STANDARD: EN 12697-1 clause B.1.1

The unit is used to extract the binder from bituminous mixtures, and to determine the moisture content. Consisting of a metallic pot complete with gauze basket and filter, Dean Stark collector, Liebig condenser, filter paper Ø 400 mm (pack of 25 pcs.)

**Dimensions:** 480x480x900 mm

**Weight:** 22 kg approx.

**ACCESSORY**
**V200-02** HOT PLATE Ø 220 mm.  
 230V 1ph 50-60Hz 2000W

**SPARE**
**B016-15** Filter paper 400 mm Ø (100 pcs.).

**B017 KIT**  
**HOT EXTRACTION APPARATUS**  
 WIRE MESH FILTER METHOD

STANDARD: EN 12697-1 clause B.1.2

This apparatus consists of a cylindrical glass jar containing a stainless steel wire basket double cloth opening 0.063 mm and 0.4 mm.

The asphalt sample (500 to 2000 g) is placed inside the wire basket, the solvent is poured inside the jar. Now the wire basket is inserted into the jar which is covered by a **stainless steel** condenser connected to a water supply. The apparatus is placed on a hot plate and the boiling solvent drips into the basket dissolving out the bitumen. The filler passing through the mesh basket must be separated using the centrifuge extractor.

**Dimensions:** Ø 160x335 mm

**Weight:** 4 kg approx.

**ACCESSORIES**
**V200** HOT PLATE Ø 185 mm 230V 1ph 50-60Hz 1500W.

**B017-02** WIRE BASKET stainless steel cloth opening 0.4 mm.

**V173-03** WIRE MESH with ceramic centre.

**SPARES**
**B017-01** WIRE BASKET stainless steel, double cloth 0.063 and 0.4 mm openings.

**B017-03** Pyrex glass jar.

**B017-05** Metal condenser **stainless steel** with ring.

**B016-10**

**B017 KIT**
**B016-20 KIT**  
**SOXHELET MODIFIED METHOD**

STANDARD: EN 12697-1 clause B.1.3

Consisting of flask 5000 ml capacity, 2000 ml extractor, cock, vapour tube and condenser; all glass made.

Complete with 25 filtering cartridges Ø 80x240 mm, isomantle electric heater, stand and clamps.

**Power supply:**

230V 1ph 50-60Hz 900W

**Dimensions:**

400x400x1000 ml approx.

**Weight:** 20 kg approx.

**SPARE**
**B016-23**

Filter cartridges for Soxhelet, inner diameter 80 mm height 240 mm (pack of 25 pcs.)

**B061 KIT**  
**KUMAGAWA**  
**(SOXHELET)**  
**EXTRACTOR**  
 1 LITRE CAPACITY

 STANDARDS: EN 12697-1  
 clause B.1.3 | LCPC

Used to extract the bitumen from hot-mixed paving mixtures. Consisting of an electric heating device, balloon 1 litre capacity, glass pipes, cooling unit and 25 filtering cartridges.

**Power supply:**

230V 1ph 50-60Hz 750W

**Dimensions:**

400x500x1000 mm approx.

**Weight:** 20 kg approx.

**B016-20 KIT**

**B061 KIT**
**B061-01 KIT**  
**KUMAGAWA**  
**(SOXHELET) EXTRACTOR 2 LITRES CAPACITY**  
 Basically similar to mod. B061 KIT but with 2 litres capacity.

**SPARES**
**B061-02** Filter cartridges, Ø 58x170 mm for Kumagawa 1 litre. Pack of 25 pieces.

**B061-03** Filter cartridges Ø 70x200 mm for Kumagawa 2 litres. Pack of 25 pieces.

## B018 BINDER RECOVERY APPARATUS.

### VACUUM PUMP HOT EXTRACTION METHOD

STANDARDS: EN 12697-1 Clause B.3.1 | BS 598:102

Used for the separation of solvent from the binder/solvent solution, and to determine the binder content in an aggregate/bitumen mixture. The apparatus consists of:

- Thermostatic water bath to keep boiling water during all the recovery cycle, complete with cover and digital thermostat, inside dimensions 280x280x230 mm.

This unit may be used also for general purposes water bath.

- Two glass flasks having 250 ml capacity, complete with rubber bungs, tubing and cocks

- Vacuum gauge (to be connected to the vacuum pump,

- Pyrex flask, 1000 ml capacity, used as vacuum bottle

**Power supply:** 230V 1ph 50Hz 1000W

**Weight:** 25 kg approx.



### NEEDED ACCESSORY

#### V203 + V205-10

VACUUM PUMP to produce a vacuum down 220 mbar, with vacuum regulator. Power supply: 230V 1ph 50Hz. Weight: 5 kg approx.

## B018-10 RECOVERY OF BINDER BY ABSON METHOD

STANDARDS: ASTM D1856 | CNR N°133

This distillation assembly is used for recovery of binder from a solution of a previous extraction, with properties substantially as those of the bituminous mixture. The apparatus consists of glassware complete set, metallic stand supports and electric heating mantle with regulator.

**Power supply:** 230V 1ph 50-60Hz 750W **Weight:** 12 kg approx.



## B019 KIT REFLUX EXTRACTOR 1000 g CAPACITY

STANDARD: ASTM D2172

This simple apparatus, working on the same operation principle of the mod. B017, consists of a cylindrical glass jar containing a metal frame supporting two metal cones of stainless steel cloth and a metal condenser on top of the jar.

Supplied complete with 100 filter papers and wire gauze.

**Dimensions:** Ø 160x510 mm **Weight:** 5 kg approx.

### ACCESSORY AND SPARES

**V200** Hot plate Ø 185 mm 230V 1ph 50-60Hz 1500W

**B019-01** Filter paper, pack of 100

**B019-02** Pyrex glass jar

**B019-03** Metal condenser

**B019-04** N° 2 stainless steel cones with frame

**V173-03** Wire mesh with ceramic centre

## B020 KIT REFLUX EXTRACTOR 4000 g CAPACITY

Similar to mod. B019 KIT but having 4000 g capacity.

**Dimensions:** Ø 280x510 mm **Weight:** 9 kg approx.

### ACCESSORY AND SPARES

**V200-02** Hot plate Ø 220 mm 230 V 1ph 50-60 Hz 2000 W

**B020-01** Filter paper, pack of 100

**B020-02** Pyrex glass jar

**B020-03** Metal condenser

**B020-04** N° 2 stainless steel cones with frame

**V173-04** Wire mesh with ceramic centre

**B020-05** Wire mesh 300x300 mm



**B067N**  
**VACUUM PYKNOMETER 10 LITRES CAPACITY**

THEORETICAL MAXIMUM SPECIFIC GRAVITY OF  
 LOOSE ASPHALT MIXTURES (RICE-TEST)

STANDARDS: EN 12697-5 | ASTM D2041

Transparent plexiglass made, complete with valve and gauge, it is used for a rapid determination of bulk specific gravity of aggregates, the max. theoretic specific gravity of bituminous uncompacted road mixtures and the percent air voids in compacted mixtures. To perform the test a minimum ultimate vacuum of 30mm/Hg is requested.

**Dimensions:** Ø 300x450 mm high

**Weight:** 8 kg approx.

**B067-01N**  
**VACUUM PIKNOMETER**

Same as model B067N but with a higher useful height (270 mm) conforming to TP Asphalt StB T5 standard.

**ACCESSORIES**
**A059-02 KIT**

VIBRO-DEAERATOR, ELECTROMAGNETIC with adjustable vibrating intensity.

To vibrate the pyknometer for the evacuation of the air.

Complete with fixing device to the pyknometer.

This unit can be used also as a Sieve Shaker.

Technical details: see Section A p. 40

**V205-01 + V205-10 + V205-12 + V230-03**

VACUUM PUMP, PORTABLE TWO STAGES, complete with vacuum regulator and condensed water trap, tubing 3 m long.

Technical details: see Section V p. 597

**B065**  
**ROTOVAPOR**  
**ROTARY EVAPORATION APPARATUS**

STANDARDS: EN 12697-3 | ASTM D5404

This unit is used to recover bitumen from a solvent by minimizing the changes in the asphalt properties.

The test is performed by distilling the residue of the solution of solvent and asphalt.

The rotating distillation flask is partially immersed in a heated oil bath, and the solution is subjected to high vacuum, with fine regulation of pressure (up to  $\pm 0.1$  kPa) according to EN 12697-3.

The Rotary Evaporation Apparatus is essentially composed of:

- distillation flask 1000 ml capacity
- motor of variable speed, (suitable to rotate the flask at an adjustable rate of 10 to 280 rpm)
- solvent recovery flask, 1000 ml capacity; condenser, heated oil bath.

The angle of the rotary/distillation flask is 15°

The instrument is supplied complete with glass tubing with three way valve and transparent flexible hose for solution intake.

The Rotatory Apparatus requires a vacuum pump and a vacuum regulating system (see accessories).

**Power supply:** 230V 1ph 50-60Hz

**Dimensions:** 740x430xh845 mm

**Weight:** 15 kg approx.

**B065**
**B065-12**
**V205-01+V230-03**
**ACCESSORIES**

**B065-12** VACUUM REGULATING SYSTEM, including regulation valve, pressure gauge and vacuum digital gauge 1 mbar resolution. Power supply: 230V 1ph 50Hz  
 Dimension: 300x200x350 mm

**V205-01** VACUUM PUMP, dual stage. Technical details: see p. 597  
 230V 1ph 50Hz

**V230-03** RUBBER TUBE, lined for vacuum, 3 m long.

**B065-14** DIATHERMIC OIL, can of 5 kg

**B065-15** EVAPORATION BALLOON, glass, flat, 3 l capacity

**B065-13** DISTILLATION FLASK, 2000 ml capacity (ASTM D5404)

**B065-16** FLOW CONTROL DEVICE with flow-meter to ASTM D5404

**V205-01 + V205-10 + V205-12 + V230-03**
**A059-02 KIT**

## B067A AUTORICE

THE ULTIMATE CONTROL FOR YOUR RICE TEST  
STANDARDS: AASHTO T209 | ASTM D2041

The AutoRice is an automatic control unit for the Maximum Specific Gravity test. Rice test results are critical for pavement quality, mixture design and laboratory mixture performance determination. By pressing a button, the AutoRice starts the vacuum pump, regulates the vacuum pressure, precisely controls the vacuum time and monitors the shaker frequency and acceleration which is a parameter that is not currently monitored during the test. Monitoring the three factors during the test can help agencies and contractors achieve better accuracy and repeatability. Data from the Rice test can be downloaded via the USB port. AutoRice has to be connected with a compatible vacuum pump, vacuum pycnometer and electromagnetic vibro-deaerator in order to perform the rice test as per standards.

### MAIN FEATURES

- Controls and monitors Rice test (AASHTO T209 & ASTM D2041) vacuum pressure and vacuum time.
- Reduces operator errors improving accuracy and repeatability.
- Provides capability to enter weights and calculate max specific gravity results.
- Replaces vacuum gauge.

### TECHNICAL SPECIFICATIONS

- Foot print: 12"x9"x4" (30x22x10 cm)
- Hose connection: 3/8" hose barb
- Max pump power: 3/4 HP
- Vacuum control:  $\pm 0.4$  mmHg at 27.5 mmHg
- Power supply: 110/220V
- Weight: 5 lbs (2.5 kg)

## B007 ASPHALT SPLITTER

This instrument is used to break and crumble asphalt samples to facilitate bulk density tests and laboratory testing purposes by reducing the granulating time in few minutes with high quality results. A rough asphalt sample of approx. 1 kg is poured into the stainless steel bowl equipped, at its bottom, with three rotating paddles. The cover is closed, the machine started, and the three paddles break and crumble the sample in grains. The bowl is now tilted to discharge the sample into the self supporting suitable pan supplied with. A hinged cabinet reducing noise protects the bowl. When opening the cover while the splitter is working, a microswitch automatically stops the machine. Conforming to CE Safety Directive.

### TECHNICAL SPECIFICATIONS

- Stainless steel bowl of 6 litres capacity
- Multirange timer: sec/min/hour
- Main switch, Start/Stop button
- Switch for reverse mode of the rotating paddles (very useful when the material restrains between paddle/bowl)
- Paddles speed: 1400 rpm
- Power supply: 230V 50Hz 1500W
- Dimensions: 490x730x855 mm
- Weight: 85 kg approx.



**B007**  
Unloading phase

**B007** Open



**B067A**

**V205-01+V205-12+V230-03**

**A059-02A**

### SPARE

- B007-11** Kit of three rotating paddles with screws.

## PARTICLE LOSS AND RESISTANCE TO FUEL

STANDARDS: EN 12697-17, 12697-43 | EN 1097-2 | ASTM C131

The test concerns the determination of the particle loss by abrasion of porous asphalt mixtures, and the determination of the resistance of a pavement or a bituminous mixture to aviation fuel.

These Standards require, within other specific tests, the abrasion tester:

### A075N LOS ANGELES ABRASION MACHINE

Technical details:

see Section "A"

Aggregates, p. 46

### B022SP BOTTLE ROLLING MACHINE

STANDARD: EN 12697-11

To determine the affinity between aggregate and bitumen, expressed by visual registration of the degree of bitumen coverage on uncompacted bitumen-coated mineral aggregate particles after influence of mechanical stirring action in the presence of water. Rotation speed adjustable from 0 up to 85 rpm.

The machine can roll up to 3 bottles at the same time.

Supplied complete with timer **range 0 - 99 hours**, to fully perform the test cycle.

**Power supply:** 230V 50-60Hz 1ph

**Dimensions:** 385x295x160 mm

**Weight:** 10 kg approx.



**B022SP + S132-01**



**B022-12**

**S132-01**

#### NEEDED ACCESSORIES

**S132-01** TEST BOTTLE, made of borosilicate glass, 500 ml capacity, diameter 86 mm, height 176 mm, 30 mm neck diameter, as expressly requested by EN Specification.

**B022-12** GLASS ROD with a diameter of 6 mm equipped with 35 mm long fitting rubber tube.



**A075N**

### A122-10 TILT TEST

The instrument measures the roughness coefficient of a joint. The unit is also designed to test the possible fluage tendency of bituminous mixtures covering a slope of a dam subject to high sun radiations. The fluage tendency is the permanent viscous deformation of a material. The apparatus consists of an inclined adjustable plane on which the sample is placed.

Inclination angle: 0 - 75°

Max. sample diameter: 100 mm

The plane is slowly tilted until sliding of the upper surface of specimen on the lower one occurs. The roughness index can be evaluated from the measured inclination angle.

**Dimensions:** 270x175x265 mm

**Weight:** 5 kg approx.



**A122-10**

## INDENTATION TEST USING CUBES OR MARSHALL SPECIMENS

STANDARDS: EN 12697-20, EN 13108-6

This EN describes a test method for determining the depth of indentation of mastic asphalt and rolled asphalt, when force is applied to them via a cylindrical indenter pin with a circular flat-ended base. The test applies to aggregates of maximum nominal size less or equal to 16 mm.

This test method is performed on mastic and road constructions asphalts, on waterproofing and floor screeds in building constructions.

The indentation test can be applied also on Marshall specimens. Condition the specimens together with their moulds for at least 60 min under water at the test temperature of 40 °C or 22 °C respectively with  $\pm 1$  °C accuracy.

### B059-10 ASPHALT INDENTATION PENETROMETER

Comprising:

- Rugged basic frame where the screw penetration load device is fixed.
  - Two interchangeable penetration pistons having 1 and 5 cm<sup>2</sup> surface.
  - Two metallic discs having total weight of 500 N ( 51 kg) that are positioned on the load device.
  - Dial gauge 30 mm, sens. 0.01 mm to measure the penetration.
  - Stainless steel water bath complete with water discharge cock.
- Heater, cube mould, test mould, **are not included** and have to be ordered separately (see accessories).

**Dimensions:** 530x600x820 mm

**Weight:** 160 kg approx.



**B059-10**

#### ACCESSORIES

##### B059-15

CUBE MOULD 70.7 mm

To prepare cube specimens.

Steel manufactured, it is easily detachable. Weight: 4350 g

##### B059-16

PENETRATION (ADJUSTABLE) TEST MOULD 69 mm.

Used during the penetration test of the cube specimen.

Made from aluminium alloy. Weight: 1850 g

##### B059-17

BASE, steel made, to fix the Marshall specimen into the Penetrometer.

Weight: 1100 g

##### B059-18

CALIBRATION DEVICE for the Indentation Penetrometer.

Weight: 700 g

##### B059-21

THERMOSTAT DIGITAL HEATING SYSTEM, complete with immersion heating element.

It heats water at the required temperature of 22 °C or of 40 °C with an accuracy within  $\pm 1$  °C as requested by Standards.

Power supply: 230V 1ph 50Hz 1500W

Weight: 3 kg approx.



**B059-21**

**B059-15**



**B059-16**



**B059-18**



**B059-17**



##### C306-03

SEPARATE CONTROL PANEL, complete with switch and electric protections, to get the heating system to CE Safety Directive



**C306-03**



## BULK DENSITY OF ASPHALT SPECIMENS

### HYDROSTATIC GRAVITY METHOD

STANDARDS: EN 12697-6, EN 12390-7

ASTM D1186, D2726, C127 | AASHTO T166, T85

#### V085

### SPECIFIC GRAVITY FRAME

Used for specific gravity determination of materials, and specifically the bulk density of laboratory compacted asphalt specimens and asphalt road cores.

Technical details: see section "V" p. 582



#### ACCESSORIES

##### V041

DENSITY BASKET, stainless steel, Ø 200 mm by 200 mm high, 3.35 mm mesh.

##### V075-11

DIGITAL BALANCE 6000 g capacity x 0.1 g sens.  
 Technical details and other models: see section "V" p. 581

##### A106

WAX MELTING POT

Technical details:  
 see section "A" p. 28

##### V300-19

PARAFFIN WAX, pack of 5000 g

##### V175-02

DIGITAL VERNIER CALIPER  
 0-200 mm x 0.001 mm



A106

## BITUMINOUS MIXTURES TEMPERATURE MEASUREMENT

STANDARD: EN 12697-13

#### V154

### DIGITAL MICROPROCESSOR THERMOMETER

Range : -50 + 950 °C, resol. 0.1 – 1 °C

Supplied **without** probes to be ordered separately (see accessories).

Technical details and other models: see section "V" p. 590



V154-01

V154

#### ACCESSORIES

**V154-01** PENETRATION PROBE, 120 mm long

**V154-02** SURFACE PROBE, 260 mm long

## BINDER DRAINAGE, BASKET METHOD

To determine the drainage of bituminous samples obtained from different mixtures of mineral fine aggregates or additives, for the evaluation of the drainage results.

STANDARD: EN 12697-18

#### B022-20

### DRAINAGE BASKET

Dimensions 100x100x100 mm, made from stainless steel sheet with Ø 3.15 mm holes.

**Weight:** 500 g approx.

#### B022-21

Tray, stainless steel made, dimensions 160x160x10 mm.

**Weight:** 500 g approx.



B022-20

B022-21

## B114 ASPHALT SAMPLES SEALING DEVICE

STANDARDS: ASTM D6752 | ASTM D6857 | ASTM D7063 | AASHTO T-331

The device is a system for sealing samples for determination of bulk specific gravity (density) of compacted and loose asphalt mixtures. The system can also be used for determining the bulk specific gravity and absorption of aggregate and stone. This product is now the standard for measurement of bulk specific gravity of open graded and absorptive compacted asphalt samples.

The samples are automatically sealed in specially designed puncture resistant polymer bags. Densities measured with this system are highly reproducible and accurate. The results are not dependent on material type or sample porosity.

**Vacuum Pump:** 1.25 HP

**Power supply:** 230V 1ph 50Hz 1430W

**Dimensions:** 490x640x510 mm

**Weight:** 91 kg approx.

### NEEDED ACCESSORIES

**B114-11** SMALL POLYMER BAGS 25x36 cm (pack of 100 pcs)

**B114-12** LARGE POLYMER BAGS 38x46 cm (pack of 100 pcs)

## B115 ASPHALT SAMPLES VACUUM DRYING DEVICE

STANDARDS: ASTM D7227 | AASHTO PP75

The vacuum drying device is specifically designed for rapid drying of compacted asphalt cores and samples. The quick and accurate dry weight, helps contractors determine pavement density close to real time and make adjustments to rolling pattern and material if necessary. It can also provide a matching baseline for density comparison between contractors and agencies.

The device dries specimens near room temperature, ensuring sample integrity and the most accurate & repeatable dry weight. Rapid moisture loss is attributed to electronic desiccation and high vacuum technologies. The system cycles a flow of ambient air and vacuum, ensuring a highly efficient moisture removal process. The state-of-the-art and patented thermoelectric cold trap is specifically designed to protect the vacuum pump from damage by capturing moisture extracted from the sample.

**Vacuum Pump:** 1 HP

**Power supply:** 230V 1ph 50Hz 1650W

**Dimensions:** 810x600x880 mm

**Weight:** 77 kg approx.



B115



B114

## B068 MOISTURE INDUCED STRESS TESTER

STANDARD: ASTM D7870

Proper testing and screening of Hot Mix Asphalt (HMA) mixes for moisture susceptibility is a crucial requirement for designing today's high-performing, longer-lasting pavements. This product is designed to simulate HMA pavement asphalt stripping mechanisms, which are due to water and repeated traffic loading. Current moisture sensitivity tests suffer from poor repeatability and test times can take up to seven days. HMA conditioning in the instrument is automatic and can be completed in less than a day.

Plug the unit into a standard wall outlet, place the sample in the chamber, select your settings and the unit does the rest. The device creates pressure cycles within the chamber to simulate the effect of moisture on the asphalt mixture. The data from the unit can be stored and transferred to a PC for evaluation and storage.

**Temperature Accuracy:**  $\pm 1$  °C

**Pressure Accuracy:** 0.25%

**Power supply:** 230V 1ph 50Hz 1650W

**Dimensions:** 1210x1210x1570 mm

**Weight:** 226 kg approx.



B068

## LABORATORY BITUMINOUS MIXERS

### AVAILABLE MODELS

#### E094

#### MIXER 5 LITRES CAPACITY

This bench mounting Mixer, is used for mixing samples of bituminous materials. Thanks to its double mixing action (shaft and planetary) it ensures uniform mixing. Two speed can be selected:

- 140 or 285 rpm for the revolving action
- 62 or 125 rpm for the planetary action

The mixer is supplied complete with stainless steel bowl, but **without** whisk to be ordered separately (see accessories).

It cannot be sold in CE markets without security guards (see mod. E095).

**Power supply:** 230V 1ph 50Hz 800W

**Dimensions:** 450x400x480 mm

**Weight:** 50 kg approx.

#### E095

#### MIXER 5 LITRES CAPACITY

Same as mod. E094 but equipped with security guards, conforming to CE Safety Directive.

#### Note:

The proper utilization of the mixers mod. E094 and E095 requires to heat the bowl with the bituminous sample at the temperature specified by the Standards. To this purpose a common laboratory oven is used, and the sample mixing (time: approx 2 minutes) is performed immediately after having taken off the bowl from the oven. As an alternative to this procedure the heater mod. B028-01 can be used.



E095-01

B028-01



E095-03

B028-03



E094 + B028-03



E095 + B028-03

### ACCESSORIES FOR E094 and E095

**B028-03** WHISK BEATER, thin wire, stainless steel, to EN Spec.

**B028-01** ISOMANTLE ELECTRIC HEATER, complete with thermoregulator. Power supply: 230 V 1ph 50-60 Hz 800 W

**E095-03** BEATER, stainless steel made.

### SPARE

**E095-01** Bowl, stainless steel, 5 litres capacity.

## MIXERS 10 AND 20 LITRE CAPACITY

Mixers characterized by a robust construction with stainless-steel bowl and whisk, suitable to ensure homogeneous and uniform mixing through planetary action.

B025N is a table-mounted unit with a capacity of 10 litres, while the B025-01N model has a capacity of up to 20 litres. In accordance with CE directives. These planetary mixers are equipped with safety switches that automatically stop mixing if the grid is lifted by the user.

Each mixer is supplied complete with a stainless-steel bowl and a whisk. Beaters and electric heaters must be ordered separately (see accessories). The machines are provided with a variable speed drive allowing to set a wide range of speeds:

- B025N:
  - 8 positions 50 to 150 rpm for the planetary action
  - 10 positions 115 to 400 rpm for the revolving action
- B025-01N:
  - 8 positions 50 to 150 rpm for the planetary action
  - 10 positions 180 to 540 rpm for the revolving action

### Note:

For a proper utilization of the mixers mod. B025N and B025-01N it is necessary to heat the bowl with the bituminous sample at the temperature specified by the Standards. To this purpose a common laboratory oven is used, and the sample mixing (time: approx 2 minutes) is performed immediately after taking the bowl out of the oven. To maintain the temperature during mixing, the mixers must be equipped with the specific Isomantle heaters (B025-05/B025-06)

### AVAILABLE MODELS

#### MIXER 10L CAPACITY:

##### B025N

**Power supply:** 220V 1ph 50Hz 370 W

**Dimensions:** 570X340X585 mm. **Weight:** 42 kg approx.

##### B025NX

Same as B025N but 220V 1ph 60Hz

##### B025NY

Same as B025N but 110V 1ph 60Hz

#### MIXER 20L CAPACITY:

##### B025-01N

**Power supply:** 400V 3ph 50Hz 732 W

**Dimensions:** 730X610X1180 mm. **Weight:** 128 kg approx.

##### B025-01NX

Same as B025-01N but 220V 3ph 60Hz 732 W



ACCESSORIES

ACCESSORIES	B025N (10 litres)	B025-01N (20 litres)
HOOK BEATER	B025-15N	-
BEATER, ALUMINIUM	B025-12N	B025-13N
ISOMANTLE HEATER 230 V 1ph 50-60 Hz 1000 W	B025-05	B025-06
WHISK	B025-18N (Ø 4mm wire - spare)	B025-10N (Ø 4mm wire) B025-19N (Ø 3mm wire - spare)
SPARE BOWL	B025-20N	B025-21N

**B026N**
**PAVEMIX**
**AUTOMATIC ASPHALT LARGE LABORATORY MIXER, 32 LITRES CAPACITY**

STANDARD: EN 12697-35 | ASTM D6307 | AASHTO TP53

The PaveMix has been expressly designed to prepare homogeneous bituminous mixtures at a strictly controlled temperature. The preparation of the bituminous sample is obtained in a short time period (few minutes) to avoid any mechanical aggregate degradation and to fully coat all mineral components, as requested by EN 12697-35.

**B026-05N**
**PAVEMIX**

LABORATORY MIXER similar to model B026N but upgraded with detachable helical mixing blades to facilitate the cleaning procedure.

**MAIN FEATURES**

- Mixing capacity: 32 litres max.
- Mixing bowl: stainless steel AISI 316.
- Slot on the top of the lid to pour filler and additives during mixing.
- Mixing temperature: selectable from ambient up to 260 °C through sensitive probe and digital display control.
- Mixing speed: adjustable from 4 to 40 rpm.
- Easy tilting unloading operation by electromechanical motion with rotation up to 130°.
- Strictly controlled temperature.
- Fast preparation of bituminous samples.

**B026N**

**The Pavemix produces representative samples to perform:**

- Gyrotory compaction tests (EN 12697-10, EN 12697-31)
- Marshall stability tests (EN 12697-34, EN 13108)
- Wheel tracking wet and dry tests (EN 12697-22)
- Slabs compaction laboratory tests (EN 12697-33)
- Beam fatigue and Stiffness tests (EN 12697-26, EN 13108)
- Asphalt general purpose tests.

**PaveMix consists of:**

- Main frame holding a horizontal stainless steel bowl with a helical mixing shaft.
- The bowl, double wall insulation made of stainless steel AISI 316, contains an electric heater with probe sensor granting constant and uniform temperature control.
- **An electromechanical motion allows to tilt the bowl facilitate the unloading operation, with total rotation up to 130°.**

**The control panel foresees:**

- Digital thermo regulator to set temperature and to control the mixing temperature.
- Mixing speed regulator.
- Main and start/stop switches.
- Rotation inversion of the blades.
- Command to tilt the bowl.

**Heating power:** 3000W

**Power supply:** 230V 1ph 50-60Hz 4500W

**Dimensions:** 1280x700x1210 mm

**Weight:** 350 kg approx.

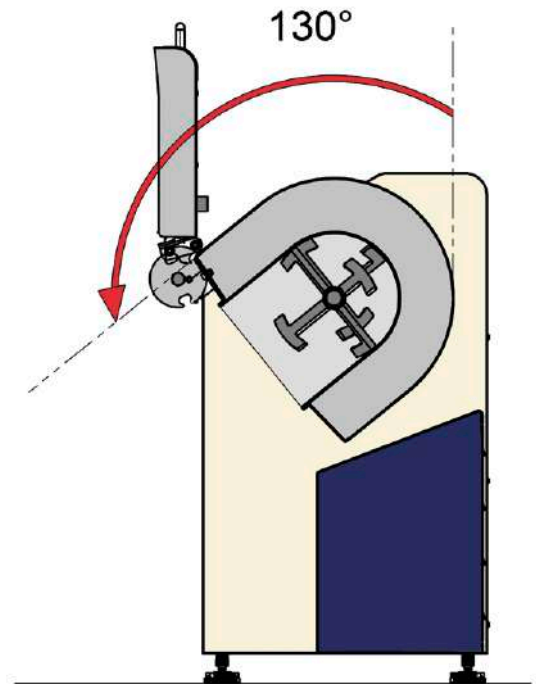

Unloading procedure.  
Easy tilting of the bowl by electric motion with rotation angle up to 130°



**B026-05N** Detail of the detachable mixing shaft with blades



NEW



Detail: mixing shaft with helical blades



Detail: slot on the top of the lid



## B031N1 MARSHALL AUTOMATIC EN (IMPACT) COMPACTOR

STANDARDS: EN 12697-10, 12697-30 | comparable to: BS 598:107

This ruggedly constructed apparatus automatically compacts the bituminous sample and stops off the motor after the preset number of blows has been completed on the automatic digital display counter.

The trip mechanism is structured so that the sliding hammer falls at the same height at every blow.

The mould is held in position by a fast clamping device.

The compactor includes a vibrated concrete base where a laminate hardwood block is mounted.

Total weight of the compaction hammer (Rod + Foot + Sliding mass):  $7850 \pm 50$  g

Sliding mass weight:  $4535 \pm 15$  g

Free fall height:  $457 \pm 5$  mm

Blow frequency: 50 blows in 55/60 seconds

The machine is equipped with safety door, conforming to CE Safety Directive.

When opened it stops automatically and cannot operate.

The control panel can be wall fixed or placed on a bench.

All moving parts are quickly/easily accessible for maintenance.

The compactor is supplied complete, **except for the mould** that must be ordered separately.

### Power supply:

230V 1ph 50Hz 300W

### Dimensions:

500x500x1890 mm

**Weight:** 220 kg approx.



**B031N 1 + B031-01**



**B031N 1**

## ACCESSORY

### B031-01

CABINET, lined with sound-proofing material for noise reduction within CE limits.

Dimensions: 800x800x2000 mm approx.

Weight: 100 kg approx.

## SPARE

**B033-11N** Compaction Hammer complete

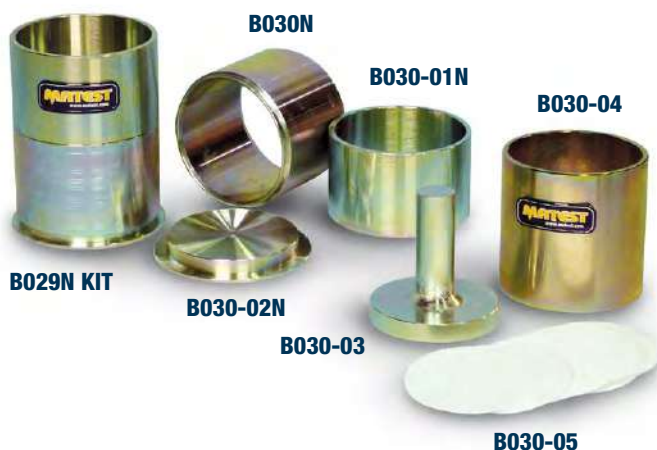

**B029N KIT**

**B030N**

**B030-01N**

**B030-04**

**B030-02N**

**B030-03**

**B030-05**

### B029N-KIT

## MARSHALL COMPACTION MOULD, Ø 4"

STANDARDS: EN 12697-10 | EN 12697-30 | NF P98-251-2

Inside diameter: 101.6 mm (4")

Steel manufactured, plated against corrosion.

**Weight:** 3.150 g

Consisting of:

**B030N** MOULD BODY only. Weight: 1300 g

**B030-01N** FILLING COLLAR only. Weight: 850 g

**B030-02N** BASE PLATE only. Weight: 1000 g

**Note:** French NF P98-251-2 Spec. requires the filling collar with a small different dimension, but fitting perfectly the mould body and the baseplate.

## ACCESSORIES

**B030-01NF** FILLING COLLAR only (NF P98-251-2). Weight: 850g

**B030-03** EXTRACTION PLATE, to eject specimens from the mould. It is used in conjunction with B030-04 receiver. Weight: 1400 g

**B030-04** SPECIMEN RECEIVER, used to receive the specimens ejected by the B030-03 extruder. Weight: 1300 g

**B030-05** FILTER DISC Ø 100 mm. Pack of 100

## B033N AUTOMATIC MARSHALL ASTM COMPACTOR FOR Ø 4" MOULDS

STANDARDS: ASTM D6926 | Comparable to AASHTO T 245

This ruggedly constructed machine has been designed to eliminate the laborious process of hand compaction. It automatically compacts the specimen and stops off the motor after the preset number of strokes has been completed on the automatic digital display counter. The trip mechanism is structured so that the hammer falls at the same height at every stroke. The unit incorporates a compaction wooden pedestal. The drive mechanism lifts the 4.53 kg. compaction hammer, plated against corrosion, to the height of 457 mm and allows free fall at nominal 55 blows per minute. The control panel can be wall fixed or placed on a bench.

This compactor is suitable only for Marshall moulds Ø 4". The compactor is supplied complete **except** for the mould which must be ordered separately.

It cannot be sold in CE markets without safety guards (see mod. B033-01N and B033-03)

**Power supply:** 230V 1ph 50Hz 300W

**Dimensions:** 540x400x1600 mm

**Weight:** 95 kg approx.

## B033-01N AUTOMATIC MARSHALL ASTM COMPACTOR FOR Ø 4" MOULDS

Same as mod. B033N, but equipped with safety guard, conforming to CE Safety Directive.

When opening the guard during Compactor working, a microswitch automatically stops the unit.

## B036T PORTABLE PEDESTAL NEW

Without doubt the "handiest" system for the compaction of Marshall specimens in situ.

The equipment consists of:

- wooden pedestal
- steel base (compaction anvil)
- mould clamping system with quick couplings.

**Dimensions:** 420x310x520 (h) mm

**Weight:** 28 kg approx.



**B036T + B034N**

**Note:** the instrument has to be completed with the compaction hammer B032-05 (for 6" diameter mould) or B034N (for 4" diameter mould)



**B033N**

**B033-01N**

**B033N + B033-03**

## B032-KIT MARSHALL COMPACTOR HAND OPERATED FOR Ø 4" MOULDS

STANDARD: ASTM D6926

Similar to mod. B033N, but the hammer is and released manually.

**Dimensions:** 320x320x1600 mm

**Weight:** 60 kg approx.

The assembly consists of:

### B034N

COMPACTION HAMMER, with 4.53 kg sliding weight, guided on a shaft. Plated against corrosion. Weight: 10 kg approx.

### B036

COMPACTION PEDESTAL, consisting of a wooden block, capped with a steel plate. Complete with mould clamp device. Plated against corrosion. Weight: 42 kg approx.

### B037

SUPPORT and hammer guide.

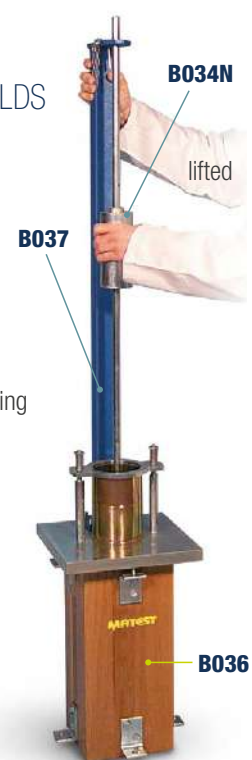

**B034N**

lifted

**B037**

**B036**

**B032 KIT**



## B035-01N AUTOMATIC MARSHALL COMPACTOR FOR 6" AND 4" Ø MOULDS

STANDARDS: ASTM D6926 | ASTM D5581  
comparable to AASHTO T245

This ruggedly constructed apparatus automatically compacts the Marshall specimens 6" and 4" diameter, and stops after the preset number of blows has been completed on the separate automatic digital display counter.

The trip mechanism is structured so that the sliding hammer falls at the same height at every blow. The mould is stationary and the hammer has flat-foot.

The mould is held in position by a fast clamping device.

The unit incorporates a compaction wooden pedestal.

The drive mechanism lifts the 22.5 lbs. compaction hammer (Ø 6"), plated against corrosion, to the height of 18" and allows a free fall at 64 blows per minute.

Sliding mass for the Ø 6" specimen: 22.5 lbs. ± 0.01 lb (10.205 kg)

Sliding mass for the Ø 4" specimen: 4.53 kg

Free fall height: 18" ± 0.1" (457.2 mm)

Blow frequency: 64 per minute ± 4

The unit is equipped by an inverter, allowing to adjust the blow's frequency.

All moving parts are quickly/easily accessible for maintenance.

The control panel can be wall fixed or placed on a bench.

The compactor is supplied complete with collar to fix the mould 6" diameter, but **without the compaction hammer 6" diameter** (mod. B035-11N) **and 4" diameter** (mod. B035-12N), and the moulds, which must be ordered separately (see accessories).

The compactor cannot be sold in CE markets without security guards (see mod. B033-03)

### Power supply:

230 V 1ph 50-60 Hz 500 W

**Dimensions:** 460x570x1700 mm

**Weight:** 180 kg approx.

**B035-01N + B033-03**  
with mould and hammer



### ACCESSORIES

**B035-11N** COMPACTION HAMMER 6" diameter, complete, for the B035-01N Compactor.

**B035-12N** COMPACTION HAMMER 4" diameter, complete, for the B035-01N Compactor.

**B035-13** REDUCTION COLLAR to fix the mould B029NKIT+B030KIT (4" Ø) to the Marshall Compactor B035-01N

**B033-03** SOUNDPROOF SECURITY CABINET, steel made, lined with sound-proofing material, complying to CE Safety Directive

## B032-01 MARSHALL COMPACTOR, HAND OPERATED, FOR 6" AND 4" Ø MOULDS

STANDARDS: ASTM D6926, D5581

Supplied complete with compaction hammer 6" diameter, wooden pedestal capped with steel plate and mould clamp device, support/hammer guide.

**Dimensions:** 320x320x1700 mm

**Weight:** 70 kg approx.

### ACCESSORIES

#### B034N

COMPACTION HAMMER 4" diameter, complete, for B032-01 Compactor.

#### B032-11

REDUCTION COLLAR to fix the mould B029N KIT+B030 KIT(Ø 4") to the Marshall Compactor mod B032-01

**B032-11**



### SPARE

**B032-05** Compaction Hammer 6" diameter, complete, for B032-01 Compactor



**B032-01**



**B035-11N**

**B035-12N**

**B035-01N**  
with mould and hammer

### B030 KIT MARSHALL COMPACTION MOULD, Ø 4"

STANDARDS: ASTM D6926 / Comparable to AASHTO T245

Inside diameter 101.6 mm (4")

Steel manufactured, plated against corrosion.

**Weight:** 3100 g

Consisting of:

**B030N** Mould body only. Weight: 1300 g

**B030-01N** Filling collar only. Weight: 850 g

**B030-08** Base plate only. Weight: 950 g

#### ACCESSORIES

**B030-03** EXTRACTION PLATE, to eject specimens from the mould. It is used in conjunction with B030-04 receiver. Weight: 1400 g

**B030-04** SPECIMEN RECEIVER, used to receive specimens ejected by the B030-03 extruder. Weight: 1300 g

**B030-05** PAPER DISC Ø 100 mm. Pack of 100.

**B030-06** BASE PLATE with handles (alternative to mod. B030-08)

### B029-01KIT MARSHALL COMPACTION MOULD, Ø 6"

STANDARD: ASTM D5581-96

Consisting of:

**B029-02** Mould body

**B029-03** Filling collar

**B029-04** Base plate

Steel manufactured, plated against corrosion.

**Weight:** 5 kg approx.

#### ACCESSORY

**S200-14** Paper disc Ø 150 mm (pack of 100).

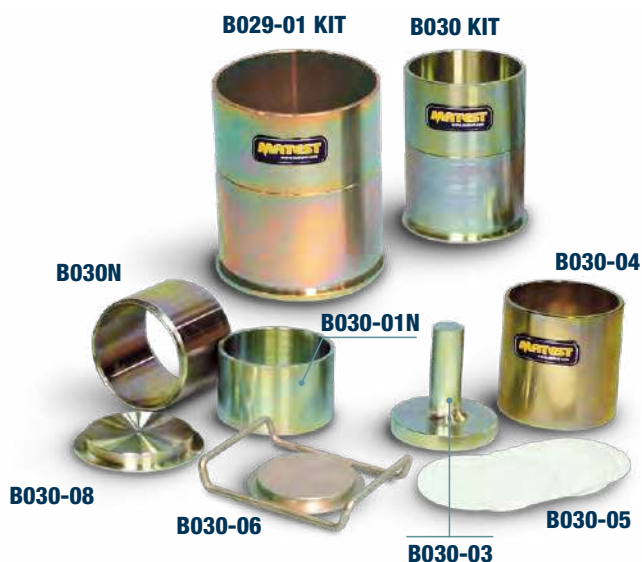

### S114 UNIVERSAL EXTRUDER

Hand operated, actuated by a 5 tons hydraulic jack, it is designed to extrude samples having Ø 4" and 6". It can therefore extrude Marshall, CBR, Standard and Modified Proctor specimens.

**Dimensions:**

Ø 300x500 mm

**Weight:** 32 kg approx.



S114

### VIBRATORY COMPACTION METHOD

#### PREPARATION OF BITUMINOUS TEST SPECIMENS

Applicable to loose mixtures and cores to determine a density ratio for a bituminous mixture.

STANDARDS: EN 12697-9, 12697-10, 12697-32, 13266-4  
BS 1377:4, 1924:2

The equipment consist of:

#### B097 P. R. D. MOULD

Vertically split on one side, foreseen of clamp attachment to the base plate, plated against corrosion, is utilized for determining the degree of compaction of bituminous pavements, for quality control purpose.

**Weight:** 12 kg



B097

#### S197N1 VIBRATING HAMMER

Double insulated motor, trigger handle, for asphalt compaction in the percentage refusal density test. It can be used also for the compaction of Proctor and CBR specimens.

Technical details: see Section "S" p. 490

#### ACCESSORIES

**B097-11N** SMALL TAMPING FOOT, Ø 102 mm  
Complete with shank.

**B097-12N** LARGE TAMPING FOOT, Ø 146 mm  
Complete with shank.

**S197-01N** SUPPORTING FRAME for vibrating hammer (see p. 490).  
Weight: 75 kg approx.



S197N1

S197-01N



B097-12N

B097-11N

## GYROTRONIC SUPERPAVE GYRATORY COMPACTOR



STANDARDS: EN 12697-10, EN 12697-31 | ASTM D6925 | AASHTO T312, TP4 | SHRP M-002

This Gyrotory Compactor, entirely developed and manufactured by Matest, is used to simulate and reproduce the real compaction conditions under actual road paving operations, hence determining the compaction properties of the asphalt.



B041-23

B041-20

B041 with accessories

### MAIN FEATURES

- Rigid steel frame ensuring excellent angle control.
- Electro-pneumatic action with servo-controlled regulator.
- Full color touch screen control unit, running like a standard PC based on Windows operating system.
- Software for PC control acquisition and data processing.
- Optional shear stress measurement.
- Concept based on American DOT principles.
- Cold mix emulsions which can be compacted.
- Optional integrated balance.
- Optional integrated extruder.
- Gyrotory angle adjustable from 0 to 2.4° (up to 3°).
- Electromechanical version available on request.

Gyrotronic working principle precisely meets the international Standards specifications avoiding any interpretation deviation. Its stable mechanism with gears and bearers a is embedded inside a sturdy frame.

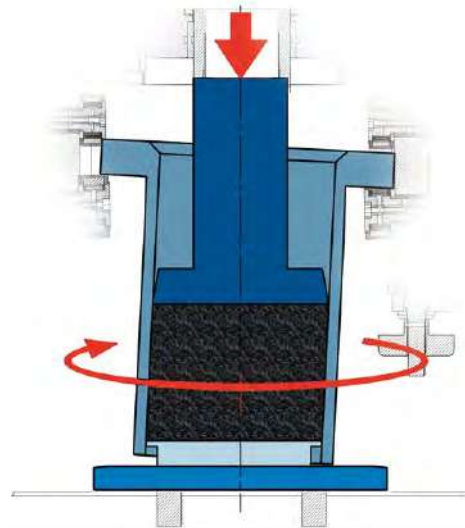

### A SUCCESSFUL PRODUCT

- COST COMPETITIVE
- TRIED AND PROVEN
- OVER 50 UNITS DELIVERED EVERY YEAR

## GYROTRONIC - SUPERPAVE GYRATORY COMPACTOR

Gyrotronic compacts in a fully automatic way, by combining the rotary action and the vertical resultant force applied by a mechanical head. The Compactor comprises a highly rigid steel frame ensuring excellent angle control.

**Load is applied by an electro-pneumatic cylinder, servo-controlled by a precision pressure regulator;** the height is measured by a linear transducer.

Gyratory motion is generated by an eccentric high precision system allowing an easy set up with precision and constant angle of gyration.

The rotation speed is controlled by an inverter through on board computer control.

Using the proper perforated mould, the Compactor is able to run tests also on cold emulsified asphalt mix.

The acquired results are also employed in the investigation of volumetric and mechanical characteristics of the asphalt mix.

**The machine is calibrated at Matest factory to the selected internal angle.**

### ADVANTAGES OF AN ELECTRO-PNEUMATIC COMPACTION SYSTEM

The Gyrotronic is equipped with a high performance, value engineered, **electro-pneumatic loading system**. The vertical actuator is low friction pneumatic cylinder and allows to apply constant stress regardless of the response of the specimen. In this way, the compaction is strictly performed in stress control and load/stress spikes are prevented. This concept provides a simple, cost effective solution with **reduced maintenance requirement**.

### ON-BOARD TOUCH SCREEN or PC CONTROL

The touch-screen icon interface allows an easy set up of the parameters and an immediate automatic execution of the test, data acquisition and processing, graphics and file. A remote test control is available through a dedicated software, provided in bundle.

Direct connection to Intranet (through LAN network) and Internet to establish a remote communication and receive an immediate diagnostic of potential problems from Matest technicians, or for software updates.

Unlimited memory storage with: 2 USB ports, 1 SD card.

Hardware technical details: see catalogue at p. 19.



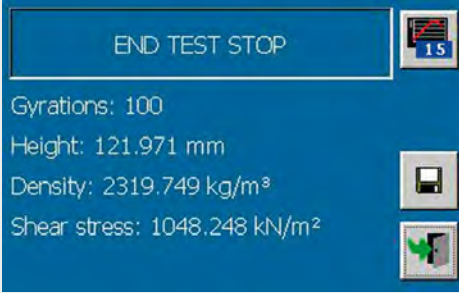

End test data (with shear stress value)

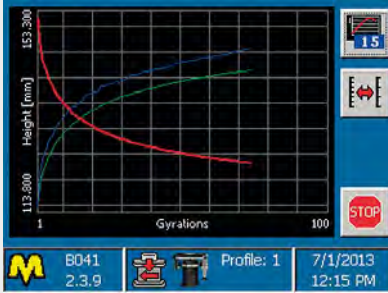

Test execution (data plot)

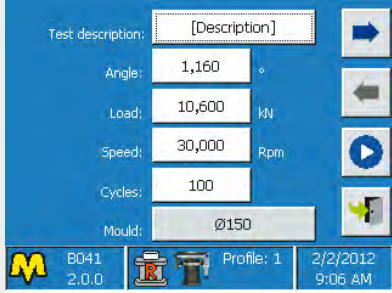

Setting of test parameters

## TECHNICAL SPECIFICATIONS

- Compacted specimen size: Ø 100 and 150 mm; height from 0 to 200 mm for both sizes.
- Mould dimensions: Internal Ø 100 and 150 mm; height 250 mm for both moulds.
- Gyrotory angle: adjustable from 0 to 2.4° (up to 3°)
- Number of cycles (gyrotory): adjustable from 1 to 5000
- Gyration rate: adjustable from 5 to 60 work cycles/min (30 cycles/min requested by Standards)
- Vertical load on Ø 150 mm specimen: adjustable from 10 to 1000 kPa (1000 kPa with 10 bar compressor) (800 kPa with 8 bar compressor) (700 kPa with 7 bar compressor)
- Vertical load on Ø 100 mm specimen: adjustable from 23 to 1500 kPa (with 7 bar compressor)
- The vertical load on the specimen is automatically controlled and adjusted by the electronic system.

Modes of operation:

- Compaction of specimen in accordance to the selected number of rotations.
- Compaction of specimen upon reaching the selected height.
- Compaction of specimen upon reaching the selected density.
- **The machine can also perform a final flatter cycle at “zero” angle to obtain specimens with perpendicular faces.**

Data acquisition: number of rotations, specimen height, applied load (to ensure tolerances requested by the Standards)

Requires pressurized air, minimum 7 bar.

The Matest Gyrotory Compactor is **supplied complete** with lubricant and power cord.

**Optional extra are:** moulds, filter paper, penetration pistons, extruder, bench, air compressor Accredia official vertical load calibration certificate, to be ordered separately (see accessories)

**Power supply:** 230V 1ph 50-60Hz 1000W 12A

**Dimensions:** 640x500x1050 mm

**Weight:** 240 kg approx.

Overview of mechanical “heart”



Compaction phase: simultaneous action of a static compression and of the shearing action



## AVAILABLE MODELS

### B041 GYROTORY COMPACTOR - ASTM

STANDARDS: ASTM D6925 | AASHTO T312 | SHRP M-002  
 The machine is calibrated at Matest factory and supplied with the internal angle set to 1.16° as requested by ASTM, AASHTO Specifications.

 **Note:** Electromechanical Gyrotory Compactor version available on request.

### B041EN GYROTORY COMPACTOR - EN

STANDARDS: EN 12697-10, EN 12697-31  
 The machine is calibrated at Matest factory and supplied with the internal angle set to 0.82° as requested by EN Specifications.

## GYROTRONIC WITH SHEAR STRESS - RESEARCH GYRATORY COMPACTOR

This model is basically structured as mod. B041 and B041EN, but, in addition, **it includes the shear stress measurement device** and therefore it is recommended for both design and research purposes.

The device provides the most important parameters required to determine the main properties of asphalt mixes, and to predict their suitability for practical uses. This integrated measurement allows user to perform tests without any additional operation. The system comes already calibrated from the factory.

### MAIN FEATURES

- Integrated shear stress measurement.
- A dedicated group of load cells measures all the involved forces acting on the specimen and through our software the effective shear stress value is calculated.
- Real time display of the instant shear stress value along with the entire compaction process.
- Calculation of the resultant load eccentricity and consequently the effective tilting moment.
- Results exportable into an Excel data report, which can be easily edited by the user.



Time:	148 sec	15	
Gyrations:	71		
Angle:	1.190 °		
Load:	599,291 kPa		
Height:	123,512 mm		
Density:	2290,807 kg/m <sup>3</sup>		
Shear stress:	1024,357 kN/m <sup>2</sup>	STOP	
M	B041 2,3,9	Profile: 1	7/1/2013 12:15 PM

Test execution with shear stress measurement

### GYROTRONIC EXCEEDS THE STANDARDS

The R&D department is continuously committed to improve the performance of SGC compactors. Matest aims to meet any type of need and purpose, from academics to researchers and routine testing laboratories, through a constant attention to quality.

The annual revisions have led to the development of a high performance electro-compaction system that exceeds the standard indications.

- Applies constant stress regardless the specimen response
- No rigid reaction to specimen behaviour
- Easy to control
- Inherently good stress/load control
- Cost competitive with low maintenance
- Reliable and precise

The following table clearly shows the reasons why Gyrotronic goes beyond the acknowledge figures.

					
<b>CONSOLIDATION PRESSURE</b>	600 kPa	600 kPa	600 kPa	600 kPa	10...1000 kPa (150 mm samples) 23...1500 kPa (100 mm samples)
<b>ANGLE</b>	0.82°	1.16°	1.16°	1.25°	Adjustable 0...2.4° (up to 3°)
<b>GYRATIONS/MIN</b>	30	30	30	30	Adjustable 5...60

### GYROTRONIC AND ACCURACY

**Gyrotronic strictly maintains the compaction angle, exceeding the EN and ASTMs standards.** In fact, the angle **IEA<sub>240</sub>** is precisely defined within an accuracy of  $\pm 0.003^\circ$ .

Also, all specifications defined in the EN 12697-31 Annex C are complied and exceeded. The maximum difference between the four individual measurements, that gives an idea about the **planarity of top and bottom faces**, is completely under the standards limit.

Another aspect is the parallelism between top and bottom faces: the difference between the Internal Top Angle, **ITA**, and the Internal Bottom Angle, **IBA**, also indicated as  $\delta_{TB}$  meets and exceeds the standard.

The compacted specimens will be perfect for mechanical analysis: parallelism between top and bottom plane, associated with right planarity, and perpendicularity between vertical walls and each plane are the fully guaranteed.

	ASTM D6925 ASTM D7115 AASHTO T312	EN 12697-31	MATEST
<b>PRESSURE</b>	600±18 kPa	600±18 kPa	
<b>ANGLE, IEA<sub>240</sub></b>	1.16°±0.02°	0.82°±0.02°	1.16° ± 0.003° 0.82°± 0.003°
$\delta_{TB} = ITA - IBA$		<0.10°	<0.02°
Max difference between individual measurements		<0.05°	<0.02°
$\delta_{LH} = IEA_{240} - IEA_{425}$		<0.10°	<0.07

## AVAILABLE MODELS

### B041-01 RESEARCH GYRATORY COMPACTOR - ASTM

STANDARDS: ASTM D6925 | AASHTO T312 7 SHRP M-002  
The machine is calibrated at Matest factory and supplied with the internal angle set to 1.16° as requested by ASTM, AASHTO Specifications.

### B041-01 EN RESEARCH GYRATORY COMPACTOR - EN

STANDARDS: EN 12697-10, EN 12697-31  
The machine is calibrated at Matest factory and supplied with the internal angle set to 0.82° as requested by EN Specifications.

## ACCESSORIES to perform the test: (for all Gyrotronic models)

- B041-05** HARDENED SPECIMEN CYLINDER Ø 100 mm complete with bottom plate
- B041-06** HARDENED SPECIMEN CYLINDER Ø 150 mm complete with bottom plate
- B041-08** HARDENED SPECIMEN CYLINDER Ø 100 mm with holes for cold mix compaction, complete with bottom plate
- B041-09** HARDENED SPECIMEN CYLINDER Ø 150 mm with holes for cold mix compaction, complete with bottom plate
- B041-11** TOP PENETRATION PISTON Ø 100 mm
- B041-12** TOP PENETRATION PISTON Ø 150 mm

Metallic discs, to make easier the handling of specimens after the test, strongly recommended accessory for low-cohesion mixtures, such as draining asphalts:

- B041-13** METALLIC DISC for Ø 100 mm moulds. Pack of 2
- B041-14** METALLIC DISC for Ø 150 mm moulds. Pack of 2

Paper discs, to prevent asphalt from sticking to the piston and the mould's base plate, and to absorb bitumen in excess:

- B041-15** FILTER PAPER for Ø 100 mm moulds. Pack of 100
- B041-16** FILTER PAPER for Ø 150 mm moulds. Pack of 100

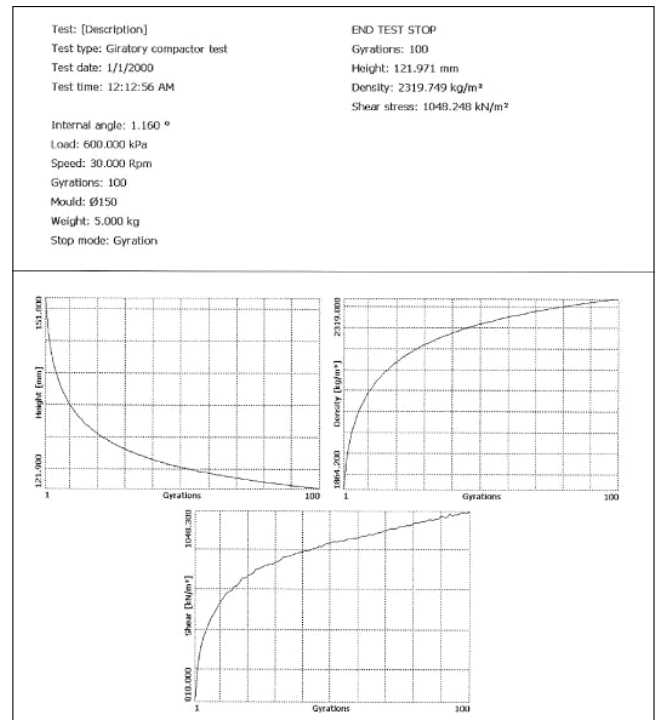

Final report

Hollow Punches for Gyrotronic Compactor:

Used to maintain the core in the right shape and store cohesive asphalt samples after compaction. Some asphalt mixes can be very unstable due to their high void ratio and large particle size. Wrapping the sample around the hollow punch will prevent it from crumbling down or receiving physical deformations once it is ejected from the mould. The material will then settle down and assume its stiff properties once it cools down after compaction:

#### B041-17

HOLLOW PUNCH to stabilize and to mature the sample Ø 100 mm

#### B041-18

HOLLOW PUNCH to stabilize and to mature the sample Ø 150 mm





**ACCESSORIES for the Gyratory Compactor:**

**B041-20** WORKTOP for B041 and B041EN, it can also accept the pneumatic specimen extruder (B041-23) and the integrated balance (B041-26)

or:

**B041-19** WORKTOP for B041-01 and B041-01 EN, it can also accept the pneumatic specimen extruder (B041-23) and the integrated balance (B041-26)

**B041-23** PNEUMATIC AUTOMATIC SPECIMEN EXTRUDER, it can be fixed to the worktop B041-19, B041-20, or to any bench.

**V207** AIR COMPRESSOR, pressure 10 bar.  
 Technical details: see p. 598

**B041-35** FILTER GROUP for condensed water removal from the compressed air. (needed accessory).

**B041-21** WHEELS (kit of 4) with brake, for an easy displacement of the Compactor in the laboratory.

**B041-30** VERTICAL FORCE TESTING DEVICE with load ring.

As alternative:

**B041-31** VERTICAL FORCE TESTING DEVICE with digital dynamometer.

**B041-33** KIT OF 2 DISTANCE PIECES of 105 and 115 mm high for the control of the height values measured by the linear transducer.

**B041-34** ACCREDIA official vertical load calibration certificate.

**WEIGHTING SOLUTIONS**

**B041-26**  
**BALANCE, INTEGRATED** into the worktop, to facilitate the sample and the mould weightings, by avoiding the stress of lifting them.

The weighting reading values are directly and automatically displayed on the control panel of the Compactor.

Capacity: 30 kg

Accuracy:  $\pm 6$  g



OR **B041-27**  
**BENCH** for lateral bearing of a weighting balance.

Suggested balance:

V075-13 Capacity 30 kg div. 0.5 g

or:

**B041-24** Capacity 30 kg div. 0.1g as requested by EN (or a balance of the customer)



## B041-28 GAM GYRATORY INTERNAL ANGLE MEASURER

STANDARDS: EN 12697-31 | ASTM D7115 | AASHTO T344

This Gyratory Angle Measurer has been designed by MATEST to provide an angle validating device. In less than 30 minutes the operator may perform the calibration of the Gyratory Compactor.

The device perfectly simulates a HMA specimen as it generates an equivalent tilting moment and shear forces.

GAM can cover a wide range of angles, including the ones specified by EN and ASTM Standards.

The device allows to perform TOP and BOTTOM angle measurements as specified by the Standards; the average of the obtained values is then considered as the **internal angle of the machine**.

An excel spreadsheet, which is supplied along with the device, is used for data acquisition and processing, and provides the precise value of the internal angle according to the calculation procedure specified by EN 12697-31 (Annex-C) and AASHTO T344.

The spreadsheet allows to plot several graphs showing the measured data and it also provides some important indexes about the quality of the data.

### MAIN FEATURES

- High accuracy of the measured data.
- Connection to PC through RS232 cable.
- Three modes of data acquisition: Single, Partial or Complete.
- Accuracy: more than  $0.01^\circ$ , as requested by the Standards.
- Data processing is carried out by a specific spreadsheet, which also allows to create the final calibration certificate.
- No need for power supply since the device is battery operated. Also it has an energy saving feature which automatically switch off the device if it is not being used for a while.
- Final calibration certificate.
- Stand-alone device (battery operated).
- Energy saving with integrated automatic switch off function.

### TECHNICAL SPECIFICATIONS

- The device is supplied complete with:
  - Two different rings to perform tests either with  $M=240\text{Nm}$  or  $M=425\text{Nm}$
  - Upper and lower base plate
  - RS232 cable
  - Strong practical suitcase
  - Calibration certificate
- Data are read by GAM and then downloaded (via RS232 cable) all together at the end of the measurements, with no need to connect the device to the PC after each measurement
- Possibility to repeat even just one of the measurement, and lately include it in the calculation spreadsheet

**Power supply:** n°2 batteries 1.5V type AA

**Dimensions:** Diameter 150 mm, Height 115 mm

**Weight:** 5.6 kg



**B041-28**

### ACCESSORIES

- B041-50** GAM CALIBRATION-CHECKING set to ASTM ( $1.16^\circ$  angle). The set is composed by two square rules. Supplied complete with factory certificate.
- B041-51** GAM CALIBRATION-CHECKING set to EN ( $0.82^\circ$  angle). The set is composed by two square rules. Supplied complete with factory certificate.
- B041-55** ACCREDIA Official Calibration Certificate of the angle, for the square rules (ASTM and EN).



**B041-50**



Calibration  
certificate

## ARC

## ASPHALT ROLLER COMPACTOR

ADVANCED ELECTROMECHANICAL SYSTEM, HIGH LOAD, HOT ROLL, MULTI SIZE

STANDARDS: EN 12697-33 method 5.2 and EN 12697-33 annex A



## GERMAN PROCEDURE TP-ASPHALT StB 33 APPROVED



B039

### MAIN FEATURES

- **40 kN vertical force.**
- Sturdy frame made of steel.
- Alternating displacement system, for table displacement and vertical load pressure.
- Integrated touch screen control unit based on Windows operating system.
- Easy management and analysis of data, test results, graphs.
- Touch-screen icon for an easy parameters set up and an immediate test execution.
- Unlimited memory storage with: 2 USB ports, 1 SD card slot.
- Direct Internet and Intranet (LAN) connection for remote technical assistance and for software updates (see p. 19).
- **Heating of the segment roller (optional).**
- Simple and quick roller and mould positioning.
- Perfect horizontal flatness of the slab surface.
- Uniform density and dimensions of the slabs.
- Easy to maintain.
- Energy controlled compaction procedure.
- Silent compaction.

HIGH  
LOADHOT  
ROLLMULTI  
SIZEHEATED  
CARTPERFECT  
SLAB  
FLATNESSTHERMAL  
SHOCK  
PREVENTION

## B039 ARC ASPHALT ROLLER COMPACTOR

ADVANCED ELECTROMECHANICAL SYSTEM, HIGH LOAD, HOT ROLL, MULTI SIZE

STANDARD: EN 12697-33 method 5.2 and EN 12697-33 annex A | ASTM D8079

Asphalt Roller Compactor is entirely developed and manufactured by Matest. The machine works with an **electromechanical system, and therefore it does not require any air source (compressor) or hydraulic pressure.**

It is used to produce representative sample slabs of several dimensions of bituminous mixtures laid and compacted on site.

The compaction is performed through a segmented roller with alternated operated rotation which simulates the on-site action of a street roller.

The compaction cycle can be programmed in accordance to a certain load or deformation value.

The flexibility of the program grants the production of samples with uniform density and dimensions, fully meeting Standards specifications and research requirements; these samples are compatible for rut test with Matest Wheel Tracking apparatus B038 (see p. 112) and Matest Smartracker B038A (see p. 114). The sample slabs can be also cored or cut off to obtain cylinders and beams for bending fatigue, indirect tensile, static and dynamic creep, stiffness, and 4-point tests.

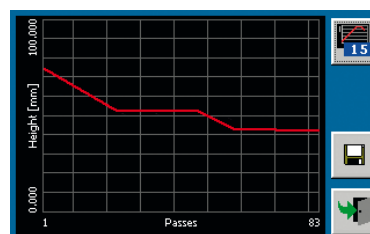

**TECHNICAL SPECIFICATIONS**

- Possibility to use **standard or heated segment rollers of different sizes** (see accessories): width up to 400 mm, length up to 500 mm and radius 490 mm, to obtain slabs of
    - 500x400 mm, thick up to 180 mm
    - 400x305x25 to 100 mm thick
    - 320 x260 mm, thick up to 180 mm
    - 305x305x25 to 100 mm thick
  - Vertical force selectable up to max. 40 kN (for all machine)
  - **Programmable density target compaction**
  - Polycarbonate safety guard as requested by CE Directive
  - Possibility to **perform the two-phase procedure (Pre-compaction and Compaction)** as specified by TP Asphalt-StB 33 and EN 12697-33 annex A
  - The required n° of passes can be set before starting the test allowing an accurate test control by n° of passes
  - **Sliding carriage speed adjustable** between 3 m/min and 12 m/min
  - **Detailed output file** listing each pass and displaying duration, sample height, applied load and eventual roller and cart temperature
  - Longitudinal compaction
- Power supply:** 230 V 50-60 Hz 1ph 2100 W  
(3100W with the heated segment roller)
- Dimensions:** 2200x1030x1880 mm  
(2410 mm with opened guard)
- Weight:** 1300 kg approx.

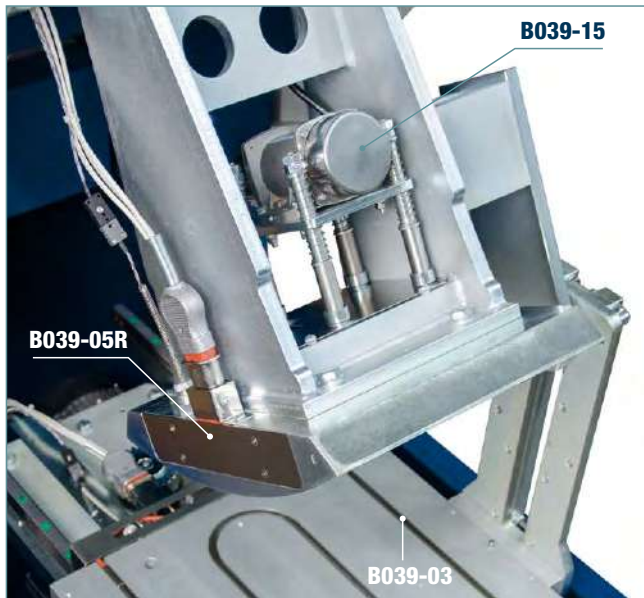

Detail of the rolling vibrating device + heated roller + heated sliding cart

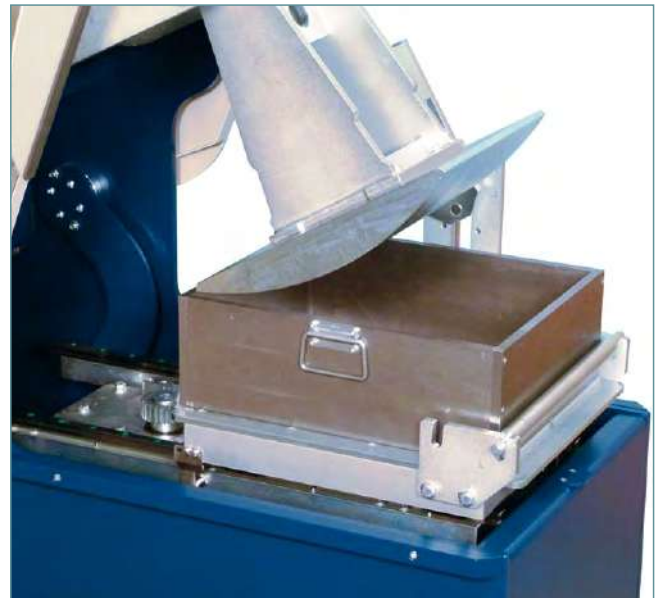

Detail of mould and roller



Optimally compacted sample with full planarity



Ideal to be cored

Three transducers are installed to manage the roller and table displacements and vertical load pressure.

**The compaction cycle can be programmed up to a certain load or deformation value.** When deformation value is programmed, the system automatically programs the suitable loads to obtain the selected final thickness.

**The flexibility of the program grants the production of samples with uniform density and dimensions, fully meeting Standards Spec. and Research requirements.**

A friendly and easy to use interface allows an immediate and fully automatic test execution, data acquisition and processing, test report and file.

The Roller Compactor is supplied **without** roller segment, slab mould, centering plate, that must be ordered separately (see accessories).

## ACCESSORIES

“STANDARD” SEGMENT ROLLER, available dimensions:

- B039-04** ROLLER for 320x260mm mould
- B039-05** ROLLER for 500x400mm mould
- B039-06N** ROLLER for 400x305mm mould
- B039-07** ROLLER for 305x305mm mould

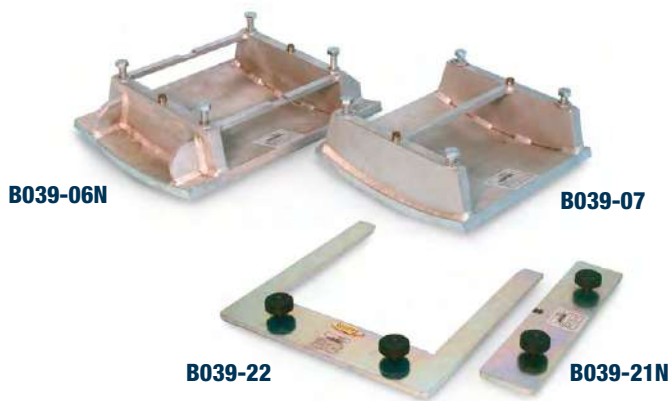

MOULD to prepare asphalt slabs. Complete with handles.

Code	Dimensions
<b>B038-09</b>	320x260x180 mm
<b>B038-10</b>	305x305x50 mm
<b>B038-11</b>	305x305x100 mm
<b>B038-12</b>	400x305x50 mm (no handles)
<b>B038-13</b>	400x305x100 mm
<b>B038-18</b>	500x400x180 mm
<b>B038-19</b>	400x305x120 mm
<b>B038-20</b>	320x260x50 mm

- B039-21N** CENTERING PLATE for 400x305 mm mould
- B039-22** CENTERING PLATE for 305x305 mm mould
- B039-23** CENTERING PLATE for 320x260 mm mould
- B039-15** ROLLING VIBRATING DEVICE, reproducing street-roller vibrations during asphalt laying off.



## HEATING OF SEGMENT ROLLER AND SLIDING CART

Possibility to heat and control temperature of the Segment Roller mounted on the Compactor and Sliding Carriage to keep the mould warm and avoid thermal shocks the might affect specimen's workability.

The equipment is composed of:

### B039-02 CONTROL UNIT

Mounted in the Roller Compactor, it foresees a thermoregulator circuit, complete with probe to measure and to adjust the temperature from room up to 180 °C.

It is connected to the segment roller equipped with heating resistances, to be connected to the control unit B039-02.

“HEATED” SEGMENT ROLLER, complete with heating resistances. Available dimensions:

- B039-04R** ROLLER for 320x260 mm mould
- B039-05R** ROLLER for 500x400 mm mould
- B039-06NR** ROLLER for 400x305 mm mould
- B039-07R** ROLLER for 305x305 mm mould

### B039-03 SLIDING CART HEATING OPTION

Thermoregulated circuit with temperature probe to set and control cart temperature and keep mould hot. The temperature is adjustable from ambient up to 140 °C.



**B039-03**

**B039A**
**ASC**
**ASPHALT SHEAR BOX COMPACTOR**

THE ONLY ELECTROMECHANICAL SHEAR BOX COMPACTOR

**NEW** STANDARD: ASTM D7981-15 Standard practice for compaction of prismatic asphalt specimens by means of the Shear Box Compactor.

The ASC is being **used in FHWA Contract** "Deployment of Performance-Based Technologies for Mechanistic-Empirical Pavement Design and Resource Responsible Materials Design" to fabricate specimens for Level 1 analyses using the AASHTOWare Pavement ME Design software.

It is the only compactor capable of fabricating specimens for all of the following mechanistic-empirical performance tests:

**Dynamic Modulus**, AASHTO PP 61

**Repeated Load Permanent Deformation**, AASHTO TP 79

**Flexural Fatigue**, AASHTO T321

**Low Temperature Creep and Strength**, AASHTO T322

**MAIN FEATURES**

- Extremely sturdy fabricated frame combined with precision machined components.
- Servo hydraulic vertical ram with integral hydraulic power supply.
- Precision electro-mechanical shearing motion (user programmable).
- Integral specimen extruder.
- Electronic control unit with touch screen color display (no need for PC).
- Unlimited memory storage with: 2 USB ports, 1 SD card slot, RS232/485 serial port.
- The compaction cycle can be programmed by specifying vertical stress/load and test termination conditions; Number of cycles, Specimen height and/or density.
- Precision load cell(s) for vertical and shear stress measurement.
- Optional built-in mould heater.

**THE MOST UNIFORM DENSITY OF ANY MACHINE**

Specimen is extruded after the machine has completed the specified number of cycles, or when the required specimen height has been reached. An automatic extruder allows an easy extraction of the compacted specimen.

**B039A**

## TECHNICAL SPECIFICATION

<b>Vertical force</b>	Up to 100kN
<b>Shearing force</b>	Up to 50kN
<b>Shear angle</b>	$4^{\circ} \pm 0.1^{\circ}$
<b>Shearing cycle rate</b>	$3 \pm 0.1$ cycles per minute
<b>Mould width</b>	$150\text{mm} \pm 0.1 \text{ mm}$
<b>Mould length</b>	$450\text{mm} \pm 0.1 \text{ mm}$
<b>Mould surface finish (inside)</b>	Smoother than $0.4\mu\text{m rms}$
<b>Mould surface hardness</b>	More than 48 Rockwell C
<b>Mould capacity</b>	Approx. 20 litres
<b>Loading platen width</b>	$149 \text{ mm} \pm 0.2 \text{ mm}$
<b>Loading platen length</b>	$449 \text{ mm} \pm 0.2 \text{ mm}$
<b>Loading platen smoothness</b>	Smoother than $0.4\mu\text{m rms}$
<b>Loading platen surface hardness</b>	More than 48 Rockwell C
<b>Number of cycles</b>	Up to 100
<b>Vertical stress</b>	$0.1 \text{ to } 1.5\text{MPa} \pm 0.01\text{MPa}$
<b>Compaction height</b>	$0 \text{ mm to } 200 \text{ mm} \pm 0.1\text{mm}$

**Power supply:** 230V 1ph 50-60Hz  
**Dimensions:** 788x1360x1314 mm  
**Weight:** 1200 kg approx.

## A RUGGED DESIGN FOR THE BEST SPECIMEN PREPARATION

Asphalt technologists are acutely aware of the importance of a representative specimen during any laboratory performance testing. The precise shearing motion of the ASC replicates the conditions of field compaction in order to reproduce the field properties of asphalt, quickly and easily under the controlled conditions of a laboratory. The ASC compacts large asphalt prisms that can be sawn to produce four to six beams or slabs for laboratory wheel tracking; or the prism can be cored to produce three to four 100 mm diameter cylinders, all having essentially identical properties. The electronic control unit, with touch screen color display, makes a PC an option, not a necessity. The user friendly touch-screen icon interface allows for easy set up parameter entry, enables immediate (fully automatic test execution) data acquisition/processing, test report, and data file generation. A LAN connection to Intranet/Internet enables remote communication to receive immediate diagnostic analysis and technical support from Matest technicians, and/or software updates

## ACCESSORIES

- B039A-01** LOADING CHUTE
- B039A-02** TRAY (2 off)
- B039A-03** SPREADING COMB
- B039A-04** LEVELING BLADE
- B039A-05** BUILT-IN MOULD HEATER (optional)

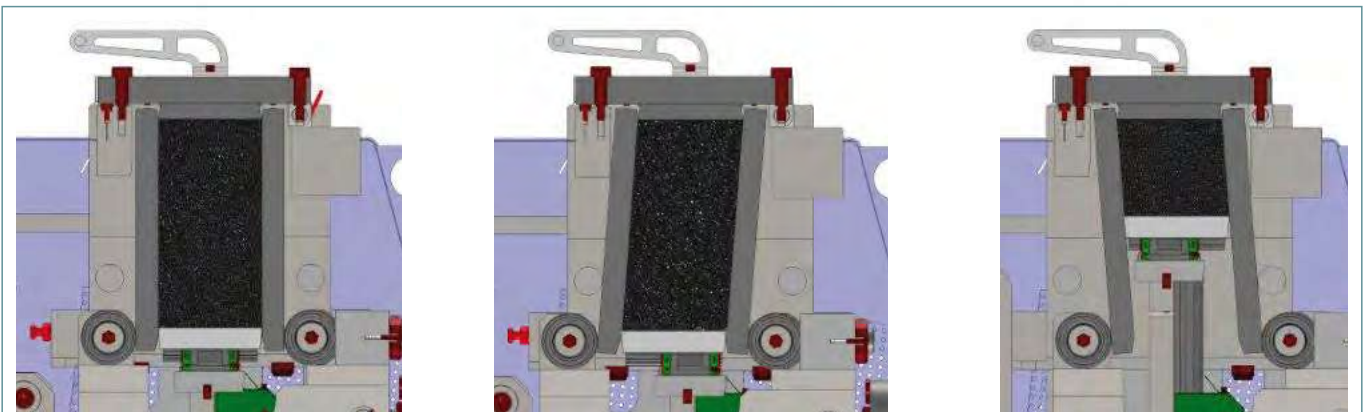

During the compaction process a lateral displacement is applied to the specimen along with a vertical load, which results in a shearing action that makes the compaction similar to the the field.

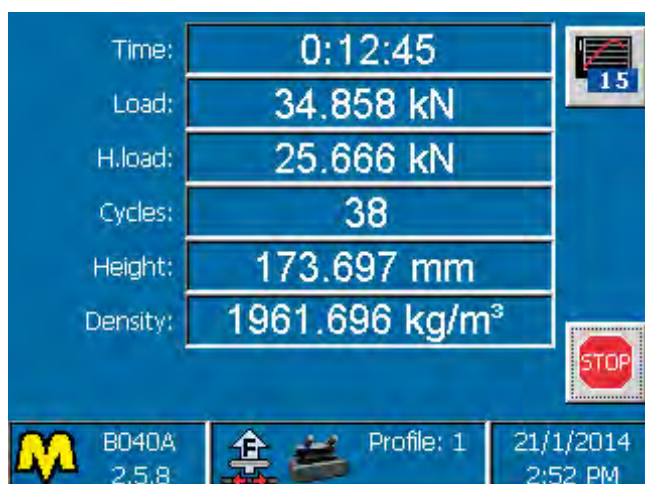

Test parameters during compaction

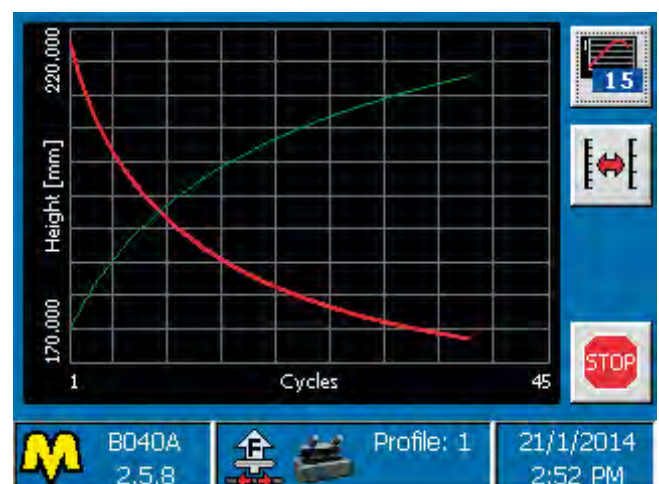

Height-Cycles and Density-Cycles curves during compaction



## B038 UNITRACKER SINGLE WHEEL TRACKING APPARATUS

STANDARDS: EN 12697-22 | BS 598:110 | Comparable to NF P98-251-1, P98-251-4

This machine is used in laboratory, for evaluating the deformation (rut) depth of a bituminous mixture subjected to cycles of passes of a loaded rubber wheel under constant and controlled temperature conditions. To perform the test, a wheel tracking apparatus is used to simulate the effect of traffic and to measure the deformation susceptibility of the bituminous sample.

Matest wheel tracker fully satisfies both EN 12697-22 and BS 598:110 specifications and may perform the test following both procedures A and B, clearly specified by the EN Standard.



**B038** with open doors

### MAIN FEATURES

- Accepts mould up to 500x400 mm, 180 mm high.
- Perfectly fit for slabs made by Matest ARC Asphalt Roller Compactor.
- Continuous realtime rut depth measurement.
- Three temperature probes for temperature control and adjustment.
- Automatic control of machine and test.
- Realtime display of: number of cycles, rut depth, temperatures.
- Realtime cycle rate also displayed when using a serial connection to PC.



**B038** detail

### TECHNICAL SPECIFICATIONS

- Travel of the table: 230 ± 5 mm
- Table cycle frequency: adjustable 15 to 40 cycles per minute.
- Hard rubber tyred wheel having outside diameter 200 mm
- Wheel load on the sample:  
700N ±10N (EN 12697-22) or 520N (BS 598:110)  
The load is applied on the sample through a lever.  
The effective load applied on the sample can be adjusted by micrometrical weights positioning.
- Continuous real time rut depth measurement (penetration of the wheel into the sample) through a linear transducer 40 mm travel by 0.01 mm accuracy.
- The test frame is made of robust aluminium alloy and it is contained in a climatic cabinet **with adjustable temperature from 30 to 65 °C ± 1.0 °C**  
**The cabinet is equipped with two doors with insulated glass for inspection**
- The sample table has dimensions: 400x390 mm and can accept rectangular slabs of several sizes:  
305x305 mm, 50 or 100 mm high  
400x305 mm, 50 or 100 mm high  
200 mm dia. core samples, 50 mm high  
The sample confinement frames are not included and have to be ordered separately (see accessories)
- Matest wheel tracker accepts also samples with dimensions up to 500x400 mm, 180 mm high (this mould can be compacted with Matest ARC: Asphalt Roller Compactor)
- The machine is supplied complete with adaptors for a correct mould positioning and locking
- The wheel tracker is equipped with 3 temperature probes:  
1 probe, connected to the thermoregulator, for the control and adjustment of the cabinet temperature.  
2 probes for temperature measurement inside the specimen.

## HARDWARE

- Data acquisition and processing system fully managed by micro-processor.
- Multifunctions keyboard with encoder for easy and rapid setup
- Large graphic display 320x240 pixel.
- RS 232 port for connection to PC.

## FIRMWARE

The multilingual testing firmware allows:

- Management and automatic control of machine and test.
- Setup of all test parameters.
- Test data acquisition and processing
- Real time display of: number of cycles, rut depth, temperatures. Real time cycle rate will also be displayed when using a serial connection to PC
- Calibration menu for setting and checking all test data.
- From the control board, it is possible to select parameters, set data acquisition and processing according to EN and BS test procedures, with:
  - Identification data of the sample (slab) under test.
  - Cycle frequency.
  - Number of passes to end the test.
  - Max rut depth to end the test.
  - Sampling frequency of the rut depth.
  - Testing temperature.
  - Sample (slab) thickness.

**Power supply:** 230V 50-60Hz 1ph 2200W

**Power rating of the table:** 500W

**Dimensions:** 1580x650x1790 mm

**Weight:** 400 kg approx.

## ACCESSORIES

- \* **B038-09** MOULD with HANDLES size 320x260x180 mm
- \* **B038-10** MOULD with HANDLES size 305x305x50 mm
- \* **B038-11** MOULD with HANDLES size 305x305x100 mm
- \* **B038-12** MOULD no HANDLES size 400x305x50 mm
- \* **B038-13** MOULD with HANDLES size 400x305x100 mm
- B038-14** MOULD for core sample 200 mm diameter, 50 mm high
- \* **B038-18** MOULD with HANDLES size 500x400x180 mm
- \* **B038-19** MOULD with HANDLES size 400x305x120 mm
- \* **B038-20** MOULD with HANDLES, size 320x260x50 mm
- H009-01** PC complete with LCD monitor 22", keyboard, mousecables, installation.

### Note:

- \* These moulds are suitable to be used also with Matest ARC: Asphalt Roller Compactor. Insert plates to reduce the thickness of the mould are available on request.



**B038-13**

**B038-18**



**B038** with closed doors

**B038AM**
**SMARTRACKER™**
**MULTI WHEELS HAMBURG WHEEL TRACKER;** TEST ENVIRONMENT: DRY+WET

STANDARDS: EN 12697-22 | AASHTO T-324

PATENT No: US 9, 964, 471

ITTECH

**CYBER  
PLUS**  
 PROGRESS

**PATENTED**

**B038AM**
**THE N° 1 UNIT IN U.S. MARKET**
**MAIN FEATURES**

- Meets and exceeds AASHTO and EN Standards.
- Simultaneous testing of wet and dry samples.
- Independent motors for each wheel assure separate rutting analysis of each specimen.
- No lifting of heavy wheel assemblies. Wheels retract automatically.
- Sturdy machine, designed for the rugged construction laboratory environment.
- Sliding sample positioning mechanism for easy mould handling and placement in the machine.
- Does not require lifting of heavy wheel components.
- Cyber Plus Progress technology allow to apply a load with a perfect sinusoidal wave in accordance with AASHTO T-324:19.
- Fully Automatic machine. Detects and stops the test when the target rut depth is reached.
- Touch-screen control unit and new icons for a modern and user friendly approach.
- Each of the two wheel assemblies is equipped with displacement transducers for rut measurement.
- Mechanical recirculating water bath for temperature control within  $\pm 1$  °C.
- Easy to load, unload, drain water and clean the unit after each test.
- Compact design to accommodate small construction labs and make maintenance easier.
- Covered by US Patent.

## B038AM SMARTRACKER™

### MULTI WHEELS HAMBURG WHEEL TRACKER - **PATENTED**

STANDARDS: EN 12697-22 | AASHTO T-324

The Hamburg wheel tracking device can be used to determine the resistance of Hot Mix Asphalt (HMA) to rutting and moisture sensitivity. Matest model "SmarTracker™" meets and exceeds EN and AASHTO.

It is intelligently designed with innovative features and the needs of the end users in mind.

The most versatile wheel tracker on the market has independent motors for each wheel which assure separate rutting analysis of each specimen. **Now you can perform wet or dry test with both wheels or run one wheel under dry and one wheel under wet condition simultaneously during a single test.**

Determine the creep slope, stripping inflection point and stripping slope with this state of the art and user friendly machine.

Equipped with the latest Cyber Plus Progress, Matest Smartracker controls the movement of the wheels in order to obtain a perfect sinusoidal wave. The measurement points for defining the rut depth are completely customizable according to EN or AASHTO Standard and for research purposes. MATEST SmarTracker™ has been developed by our R&D engineers and scientific in association with some of the most experienced and reputable industry experts in the USA and the world.



Unique system to  
Load-unload the mould



Innovative wheels roll off Mechanism  
(patented)



Real time results plot of the rut  
depth along with the no. of passes.

**TECHNICAL SPECIFICATIONS**

- Wheel load: 705 N
  - Wheel speed: from 20 to 30 cycles/minute.
  - Temperature control:  
EN 12697-22: 2500W heaters for air temperature control, ventilation for temperature uniformity, probe for air temperature, all controlled by the electronic system.  
AASHTO T324: 4000W heaters, recirculating pump, automatic feed and controls level.
  - Temperature control range: from ambient up to 75°± 1 °C
  - Table travel: 230, 260, 280 mm
  - Rut depth transducers range: 25 mm ± 0.1 mm accuracy.
  - Slab thickness: adjustable from 38 to 120 mm
- Power supply:** 220V 50-60Hz  
**Dimensions:** 1400x1300x1300 mm  
**Weight:** 450 kg approx.

**MAIN FEATURES**

- No added stress to operators back from lifting heavy wheel assemblies.
- Sample holders slide into position and eliminate demanding lifting and placement of samples into the unit.
- Hood keeps technicians away from moving parts and provides better temperature control while the test is being conducted.

**B038AM-15  
SMARTTRACKER HAMBURG VERSION AASHTO T324  
(WATER TEST ONLY)**

STANDARDS: AASHTO T324, AMAAC Mex Protocol  
 Same as model B038A but without cover, it allows water test only.



**B038AM-15**

**TESTING SOFTWARE**

The user-friendly software is integrated into the on-board digital control unit based on Windows operating system. The software is fully customizable by the operator according to EN and AASHTO Standards, and the personal needs. Automatic calculation of stripping inflection point (AASHTO). Test execution and all parameters, such as water/air temperature, specimen temperature, rut depth can be monitored in real time. The software also allows exporting test data to an Excel compatible format.



**B038A-16 SOFTWARE HWT-REPORT TO AASHTO T324**

The Unique HWT-Report software allows the user to analyze the results from the SmarTracker to generate a report and a graph strictly conforming to AASHTO T324. The features of the software include the ability to analyze different locations along the wheel pass, graph maximum and average rut depths, stripping inflection point and detailed reports (selecting all the wheel passes or different sampling rates) that can be presented, printed or emailed.



TABLE OF ACCESSORIES TO PERFORM DRY (AIR) AND WET (WATER) TEST FOLLOWING EN 12697-22 AND AASHTO T324 SPECIFICATIONS

Standards	EN 12697-22		AASHTO T324	
Testing mode	Dry (air)	Wet (water)	Wet (water)	* Dry (air)
	2x <b>B038A-01</b> Rubber wheel	2x <b>B038A-01</b> Rubber wheel	2x <b>B038A-02</b> Steel wheel	2x <b>B038A-02</b> Steel wheel
	2x <b>B038A-11</b> EN Mould	2x <b>B038A-11</b> EN Mould	2x <b>B038A-06</b> Probe (optional)	2x <b>B038A-10</b> or 2x <b>B038A-11</b> Mould
	<b>B038A-12</b> <b>B038A-13</b> Adaptors	<b>B038A-12</b> <b>B038A-13</b> Adaptors	FOR CYLINDRICAL SPECIMENS: 2x <b>B038A-10</b> AASHTO Mould	2x <b>B038A-03</b> Tool
	<b>B038A-05</b> Air heating	<b>B038A-06</b> Probe (optional)	2x <b>B038A-03</b> Tool	<b>B038A-12 +</b> <b>B038A-13</b> Adaptors
	2x <b>B038A-06</b> Probe (optional)		<b>B038A-10D</b> Adaptors	<b>B038A-05</b> Air heating
			FOR SLAB SPECIMENS: 2x <b>B038A-11</b> Mould	2x <b>B038A-06</b> Probe (optional)
			<b>B038A-12+B038A-13</b> Adaptors	

**B038A-01**

Rubber wheel for EN 12697-22

**B038A-11** EN mould

 **Note:** \*AASHTO T324 does not require air test.

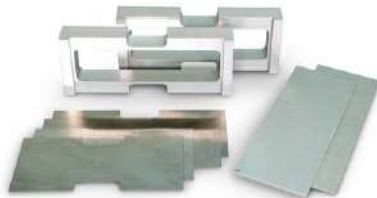
**B038A-13** Horizontal adaptors for EN moulds**NEEDED ACCESSORIES****EN 12697-22**

- B038A-01** RUBBER WHEEL 203x50 mm  
**B038A-11** EN MOULD 400x305x120 mm  
**B038A-12** SET OF VERTICAL ADAPTORS for EN mould to allow the positioning of specimens lower than 120 mm (up to a minimum specimen thickness of 20 mm)  
**B038A-13** SET OF HORIZONTAL ADAPTORS for EN mould to allow the positioning of specimens 260x320 mm and 305x305 mm

**AASHTO T324**

- B038A-02** STEEL WHEEL 203x47 mm  
**B038A-10** AASHTO MOULD (2 cylinders Ø 150x60 mm)  
**B038A-03** TOOL for AASHTO positioning  
or  
**B038A-07** STAINLESS STEEL TOOL for AASHTO positioning  
**B038A-10D** VERTICAL ADAPTORS for AASHTO mould to allow the positioning of specimens with a thickness of 40 mm

**B038A-10**  
AASHTO mould**B038A-02**  
Steel wheel for AASHTO T324**B038A-14****OPTIONAL ACCESSORIES**

- B038A-04** ELECTROVALVE group for hot water  
**B038A-05** AIR HEATING SYSTEM for air conditioning test EN 12697 -22  
**B038A-06** PROBE for specimen's temperature determination  
**B038A-09** HPDE mould specimen holder.  
**B038A-14** VERIFICATION KIT for the calibration of the wheel load. The calibration kit is designed to facilitate the calibration or to check the machine's wheel load. The device is composed of a support block with a calibrated load cell and complete with a digital readout. Max. load 1000 N, accuracy 0.05%.

**B040**
**APS**
**AUTOMATIC PAVE SAW**

**DUAL BLADE CONCEPT FOR PERFECT PARALLEL CUTTING**

Matest has developed a dual bladed automated sawing system for fast, accurate cutting of cores, prisms and slabs prepared using Matest's range of asphalt compaction machines; GYROTRONIC-Gyratory Compactor, ASC-Asphalt Shear-box Compactor and ARC-Asphalt Roller Compactor for Four Point Bending (4PB), Two Point Bending (2PB), Overlay tester (OT), Semi Circular Bending (SCB) and wheel tracking tests using Matest/ Pavetest's range of leading edge testing systems.

It includes: **cooling water recirculation pump, tank and protection cabinet with interlocks to ensure operator safety.**

**B040**

**MAIN FEATURES**

- Two saw blade design ensures for perfect parallel cutting.
- Motorized feed with automatic retraction of saw carriage.
- Electronic control unit with touch screen colour display, that runs like a standard PC based on Windows operating system.
- Adjustable cutting speed.
- Slabs and prisms can be sawn safely and accurately.
- Jigs also available for trimming 100 and/or 150mm diameter cylinders/cores.
- Facilitates cutting rectangular beams, trapezoidal prisms, overlay test specimens, semi-circular & wheel tracking specimens, and cylindrical specimens.
- Simple spacer system allows precise preparation of beams and cylinders from 38mm to 160mm long, without the need for measurement.
- Other dimensions can be accommodated using integral ruler.
- Adjustable limit switches facilitates repetitive cutting with minimal saw carriage travel. Secure specimen clamping. Choice of mechanical or pneumatic.
- Protective enclosure, with safety interlocks, combines clean operation with unparalleled operator safety.
- Dynamic breaking system stops saw blade rotation when power is switched off.

## THE NEXT GENERATION FULLY AUTOMATED ASPHALT SAWING SYSTEM

Matest's new APS-Automatic Pave Saw is the next generation fully automated asphalt sawing system with integrated specimen clamping. **The APS offers fast and accurate cutting of rectangular beams, trapezoidal prisms, overlay test specimens, semi-circular specimens, and trim- ming of cylindrical specimens.**

**The APS uses two blades** to ensure perfect parallel cutting of cylinders and beams at set intervals from 38 to 160 mm long. If equipped with proper blades, the APS cuts not only asphalt but also several other materials.

The APS is controlled using Matest's tried and proven **iTouch electronic** control unit with touch screen colour display for perfect cutting of specimens for AASHTO, ASTM and EN standards without the need for manual measurements. **It is the safest and most advanced asphalt cutting saw** available on the market and is the perfect companion to our range of advanced asphalt preparation and testing equipment.

The APS is capable of cutting prismatic specimens up to 240mm high and a cutting length up to 700mm and cylindrical specimens up to 200mm diameter. **The APS can be configured using one or two blades, with a large range of jigs and fixtures** to cut rectangular beams, trapezoidal prisms, overlay test specimens, semi-circular & wheel tracking specimens, and trim cylindrical specimens accurately, with excellent parallelism and perpendicularity. Various alignment blocks, guides and reference spacers allow operators to easily achieve the most commonly used dimensions specified in a range of international standards with little or no measurement. Any other dimensions can be accommodated with the aid of an integrated ruler.

The **iTouch controller** allows the operator to easily control the cutting speed and sequence and a series of adjustable limit switches minimizes the saw carriage travel during repetitive cutting. The high grade stainless steel work surface and associated corrosion resistant components ensures the unit will perform well and look good for many years.

The **protective enclosure** provides a high level of operator safety and protection from water spray. Safety interlocks prevent the operator from opening the enclosure and accessing hazardous areas while the blade is rotating. Once the cutting sequence has finished and the blade has stopped rotating, the enclosure is unlocked automatically.

### ACCESSORIES

- B040-01** APS DIAMOND BLADE, 650 mm diameter (q.ty 1 or 2) or
- B040-02** APS DIAMOND BLADE, 700 mm diameter (q.ty 1 or 2)
- B040-03** SET OF SPACERS for mounting the APS Diamond blade, 650 mm diameter (needed for B040-01)
- B040-04** SET OF SPACERS for two blades configuration (needed for two blades configuration)
- B040-05** SPACER for one blade configuration (needed for one blade configuration)
- B040-06** DISPLACEMENT TRANSDUCER for the control of the blade position
- B040-07** PNEUMATIC CIRCUIT (needed with Pneumatic cutting jigs)

If equipped with pneumatic cutting jigs, the unit requires compressed air, minimum 8 bar



### SPECIFICATIONS

- One or two blade concept
- Blade Diameter(s): 650 mm or 700 mm
- Blade Speed 1,400rpm (50Hz) or 1,680rpm (60Hz)
- Adjustable cutting speed, min 40 mm/min max 200 mm/min
- Max Cutting Depth 200 mm (with 650 mm blade diameter) or 240 mm (with 700 mm blade diameter)
- Cores 100 or 150 mm diameter (38 mm or 200 mm diameter on request )
- Max Prism Length 700 mm
- Cooling water recirculation pump and tank included
- Net Weight 500 kg approx.
- Parallel (Dual blade) cutting distance: 38 mm to 160 mm at set distances
- Dimensions 2370 mm (L) x 1340 mm (D) x 1670 mm (H)
- Air Supply 600 kPa (for pneumatic clamping option)
- Power Supply:
  - 400V 50Hz 3ph, 230V/220V 50Hz 3ph (B040)
  - 400V 60Hz 3ph, 230V/220V 60Hz 3ph (B040X)
  - 208V 60Hz 3ph (B040Z)

### CUTTING JIGS

- B040-10M** APS manual Multi-Slab/Prism jig suitable for slabs and prisms with the following dimensions: 40 - 240 mm depth x 700 mm length.
- B040-10P KIT** APS automatic Multi-Slab/Prism jig suitable for slabs and prisms with the following dimensions: 40 - 240 mm depth x 700 mm length.
- B040-12M** APS manual trapezoidal specimen jig for two point bend (it requires B040-10M or B040-10P-KIT).
- B040-13M** APS manual core docking jig for Ø 150-100-60-50-40-38 mm cores.
- B040-13P** APS automatic core docking jig for Ø 150-100-60-50-40-38 mm cores.
- B040-14** Instrumentation for Overlay test, wheel tracking core, semi-circular and disk shaped compact tension specimens (it requires B040-13M or B040-13P).



**B040-20**
**ACD**
**AUTOMATED CORE DRILL**

Matest has developed an Automated Core Drill (ACD) for fast, accurate cutting of cores from cylinders, prisms and slabs prepared using Matest's range of asphalt compaction machines; GYROTRONIC-Gyratory Compactor, ASC-Asphalt Shear-box Compactor and field specimens for subsequent testing using Matest/Pavetest's range of leading edge testing systems.

**MAIN FEATURES**

- Three selectable drill speeds.
- Clear protective/splash screen conforming to CE standards.
- Ideal for coring prismatic specimens compacted in Asphalt Shear-box Compactor (ASC).
- Suitable to core cylindrical specimens compacted in Gyratory compactor(s).
- Includes water container/tray.
- Adjustable specimen clamp eliminates specimen movement during coring.
- Three position fixture provides easy and accurate specimen positioning.
- Three core supports at fixed spacing yields two or three cores from one prism.
- Optional cylindrical specimen jig.

**B040-20**
**SPECIFICATIONS**

Drill Bit Diamond/tungsten alloy, laser welded.  
 Core diameter 100 mm or 150 mm.  
 For other core diameters, see the accessories.  
 Core height up to 40 cm.

Specimen sizes:

- Cylindrical Sample: 160 mm x 70 mm - 400 mm ( $\varnothing$ xH)
- Prismatic Sample:  
 200-450 mm x 150-185 mm x 120-420 mm (LxDxH)  
 315-340 mm x 220-260 mm x 120-420 mm (LxDxH)

**Dimensions:** 60 cm (L) x 80 cm (D) x 140 cm (H)

**Net weight:** 85 kg

**Power supply:** 230V 10A 50Hz 1ph (540/1, 300/1, 800 rpm)  
 230V 10A 60Hz 1ph (560/1, 330/1, 850 rpm)  
 115V 20A 60Hz 1ph (560/1, 330/1, 850 rpm)

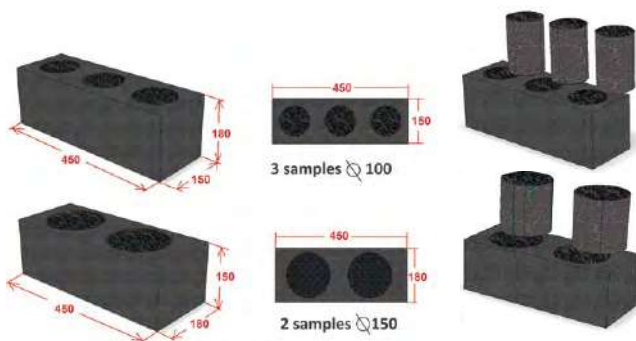
**MODELS**

**B040-20** Asphalt Core Drill (230V/50-60Hz) for prisms

**B040-20Y** Asphalt Core Drill (110V/60Hz) for prisms

**ACCESSORIES**

**C339-03**  $\varnothing$  100 x 420 mm long drill bit (needed)

**C339-04**  $\varnothing$  150 x 420 mm long drill bit (needed)

**B040-21** Clamping cylindrical specimen jig to suit from 50 to 150 mm diameter specimens (needed)

**B040-22 KIT** DCT specimen. It includes:

■ **B040-22** DCT specimens drilling jig

■ **B040-33**  $\varnothing$  25 x 420 mm long drill bit

**B040-21**

**B040-23 KIT** Transversal coring. It includes:

■ **B040-23** Transversal coring jig

■ **C339-02**  $\varnothing$  75 x 420 mm long drill bit

■ **B040-30**  $\varnothing$  38 x 420 mm long drill bit

■ **C339-01**  $\varnothing$  50 x 420 mm long drill bit

**B040-31**  $\varnothing$  42 x 420 mm long drill bit

**B040-32**  $\varnothing$  55 x 420 mm long drill bit

**C346** Core Extractor  $\varnothing$  50 mm

**C346-01** Core Extractor  $\varnothing$  75 mm

**C346-02** Core Extractor  $\varnothing$  100 mm

**C346-03** Core Extractor  $\varnothing$  150 mm

**B040-21**

## B042T 50 KN MARSHALL TESTING MACHINE

STANDARDS: ASTM D6927, D5581, D1559 | AASHTO T245  
BS 598 :107 | NF P98-251-2

This sturdy frame, easy to use and maintain, is designed to perfectly bear strain and loads required during the test. The plate is raised at a constant rate of 50.8 rpm by means of an electrical motor.

Vertical span: maximum 480 mm, minimum 300 mm.

The applied load is measured by a proving ring 30 kN, supplied with calibration certificate. An electrical device is included to stop automatically the machine when reaching the maximum load capacity, in order to prevent damages caused by overload.

Two safety microswitches limit cylinder stroke while controlling stability measuring instrument.

The testing machine is fully equipped with 30 kN load ring, mould, flowmeter with dial gauge.

**Power supply:** 220V 1F 50Hz 750W

**Dimensions:** 500x450x1400 mm

**Weight:** 110 kg approx.

## B047-02 TENSILE SPLITTING DEVICE

STANDARDS: EN 12697-23 | ASTM D6931 | AASHTO T283

Used to measure the splitting tensile strength and the radial strain of a Marshall specimen  $\varnothing$  4" and 6", where a vertical load is applied. Supplied complete with loading strips to test specimens having  $\varnothing$  4" and 6". Steel manufactured, plated against corrosion.

**Dimensions:**  $\varnothing$  248x270 mm - **Weight:** 14 kg approx.

Alternative solution:

**B047-02S** 

TENSILE SPLITTING DEVICE for samples  $\varnothing$  4" and 6" complete. Simple model not accepting the device B047-03 for strain measurements.

## ACCESSORY

**B047-03** SET OF TWO DIAL GAUGES 10 mm stroke and 0.01 mm sens. complete with adjustable supports for strain measurements, to CNR N.134

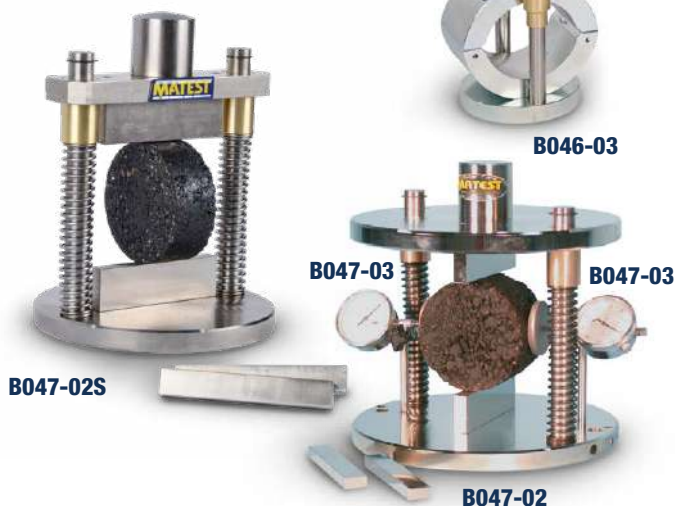

**B046-03**



**B042T**

## SPARES

### B046N

STABILITY MOULD,  $\varnothing$  4" (101.6 mm)

The mould, **aluminium made**, is completely open in the front and the introduction of the specimen becomes very easy thus avoiding disassembling operations. Weight: 6 kg approx.

### B046-03

STABILITY MOULD, **steel made**,  $\varnothing$  4" (101.6 mm) to ASTM D6927.

Alternative solution to B046N mould.

Weight: 9 kg approx.

### B047

FLOW METER

Mounted on top of the stability mould, holding the dial gauge and incorporating a stem-brake keeping maximum deflection. Weight: 500 g

### B047-01

DIAL GAUGE

Stroke 10 mm, div. 0.01 mm to be used in conjunction with the Flow Meter B047.



**B046N**

**B047**

**B043 KIT**  
**DIGITAL MARSHALL TESTER 50 KN CAPACITY**

STANDARDS: EN 12697-34, 12697-23, 12697-12  
 ASTM D6927, D5581, D1559 | AASHTO T245  
 BS 598:107 | NF P98-251-2

The testing frame is the same as for mod. B042 KIT, but the load is measured by an electric cell 50 kN capacity with high precision strain transducers; the flow is measured by an electronic displacement transducer 50 mm stroke and  $\pm 0.1\%$  linearity.

The Cyber-Plus Evolution 8 channels digital display unit with micro-processor (technical details: see B044N-SET p. 132, Hardware technical details: see p. 19) measures and displays at the same time the stability in kN and the flow in mm with peak hold features, with the possibility to transfer them to a PC and a printer through a RS232 port.

Supplied complete with Stability mould.

**Power supply:** 230V 1ph 50Hz 900W

**Dimensions:** 650x400x1100 mm

**Weight:** 120 kg approx.

**ACCESSORIES**
**B043-01N**

SOFTWARE UTM2 (Universal Testing Machine 2)

Licence for MARSHALL test

Standards: EN 12697-34 | ASTM D6927, D5581, D1559  
 BS 598:107 | NF P98-251-2

Data processing program for "X-Y STABILITY/FLOW"

General description and technical details: see UTM2 p. 18

**B046-03**

STABILITY MOULD, **steel made**, for  $\varnothing 4"$  (101.6 mm)

Specimens to ASTM D6927.

Alternative solution to B046N mould.

Weight 9 kg approx.

**B046N**
**B046-03**

**B043 KIT**
**SPARE**
**B046N**

STABILITY MOULD  $\varnothing 4"$  (101.6 mm)

The **aluminium made** mould, is completely open in the front so the introduction of the specimen is made easy as there is no disassembly needed.

Weight: 6 kg approx.



B043-01N: Load/deformation "x-y" graphic example

**Note:** The Digital Marshall Tester B043KIT, completed by the specific accessories (listed below) is suitable to perform also the following tests:

## DETERMINATION OF INDIRECT TENSILE STRENGTH

STANDARDS: EN 12697-23, EN 12697-12 | ASTM D6931  
AASHTO T283

### B047-02

TENSILE SPLITTING DEVICE FOR SAMPLE Ø 4" AND 6"  
Used to measure the indirect tensile strength and the radial strain of a Marshall specimen Ø 4" and 6", where a vertical load is applied. Supplied complete with loading strips to test specimens having Ø 4" and 6". Steel manufactured, plated against corrosion.

**Dimensions:** Ø 248x270 mm

**Weight:** 14 kg approx.

Alternative solution:

**B047-02S** TENSILE SPLITTING DEVICE for samples Ø 4" and 6" complete. Simple model not accepting the device B047-04 for strain measurements.



## ACCESORIES

**B047-04** SET OF TWO LINEAR RESISTIVITY TRANSDUCERS, stroke 10 mm, accuracy and linearity  $\pm 0.3\%$  to meet CNR N.134. Complete with supports and accessories for strain measurements.

**B044-03** DISPLACEMENT TRANSDUCER, **additional**, 50 mm stroke, for a double measurement of the vertical displacement of the specimen during the tensile splitting test. Complete with cable and connector. When used with B043-02N software the average value of the two transducers is given.

**B043-02N** SOFTWARE UTM2 (Universal Testing Machine 2)  
Licence for INDIRECT TENSILE STRENGTH  
Standards: EN 12697-23, EN 12697-12 | ASTM D6931  
AASHTO T283

General description and technical details:  
see UTM2 p. 18

## DIRECT SHEAR (LEUTNER) BETWEEN BITUMINOUS STRATA

STANDARD: ALP A StB T.80

Direct shear test (LEUTNER) on the connection between bituminous strata, carried out on asphalt cylinder specimens diameter 150 mm or 100 mm obtained from road cores or on laboratory made specimens.

## NEEDED ACCESSORIES

### B047-10

LEUTNER testing head for specimens Ø 150 mm

### B047-11

SPACERS for Ø 100 mm specimens with Leutner head.

### B043-03N

SOFTWARE for Marshall and Leutner tests.



**B047-10 + B047-11**

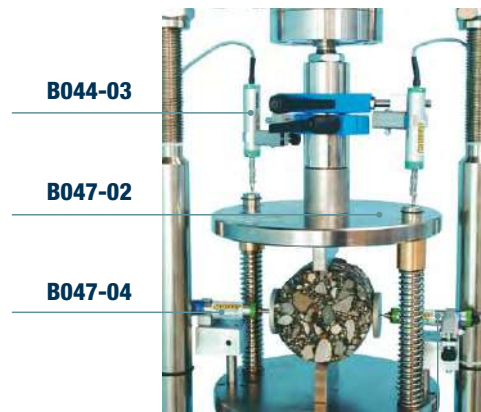

### B047-06

## DIGITAL UPGRADE FOR ANALOG LOAD FRAME

STANDARDS: AASHTO T283, ASTM D6931 and D4867

- For tensile strength tests performed in the lab
- 100 Hz data collection rate
- Displays exact peak load, reducing potential of operator error
- Eliminates the need for plotters and plotter pens
- Provides digital record for printing, storage or email



## WATER SENSITIVITY OF BITUMINOUS SAMPLES

STANDARD: EN 12697-12

This test determines the effect of saturation and accelerated water conditioning on the indirect tensile strength of bituminous mixtures, by evaluating the effect of moisture with different sample conditions.

Equipment: Digital Marshall tester B043KIT, indirect tensile strength accessories, and also:

### B052-02

## WATER BATH, DIGITAL, WITH COOLING DEVICE

Temperature range: +3 to +95 °C, accuracy  $\pm 1$  °C.

(EN 12697-12 Standard requires a temperature to be selected in the range of +5 to +25 °C).

Capacity: 45 litres

Inside dimensions:  
635x360x205 mm

The bath can also be used for Marshall tests and general laboratory purposes.

Technical details: see p. 135



**B052-02**

**MULTI-FUNCTION TESTING FRAMES, ALSO SUITABLE FOR MARSHALL TESTS**
**S213-05N  
 CBR/MARSHALL 3 SPEEDS FRAME 50 KN** 

The frame is provided of three fixed speed ranges, easily selectable with a frequency changer (inverter) activated by an electric switch:

1.00 mm/min for CBR tests (as Australian and old BS Standards)

1.27 mm/min. for CBR tests

50.8 mm/min for Marshall tests.

Supplied **without** load ring and accessories which have to be ordered separately.

Technical detail: see p. 494

**S212M  
 UNIVERSAL MULTISPEED LOAD FRAME 50KN** 

This motorized machine with electronic **digital touch-screen** controlled by microprocessor, is suitable to perform all the tests when the requested speed rate is within:

**0.05 to 63 mm/min** with max. load of 50 kN

It can therefore perform:

- Marshall test with rate of 50.8 mm/min.
- Splitting tensile test on Marshall specimens.
- Unconfined, CBR tests.

Supplied **without** load ring and accessories which have to be ordered separately.

Power supply: 230V 1ph 50-60Hz 750W

Technical Specifications: see p. 494

**S212M**

**B046-03**

**S213-05N + MARSHALL accessories**

**ACCESSORIES for S212M and S213-05N frames**

MARSHALL test, Ø 4":

**S212-05** Load piston

**B046N** Stability mould Ø 4" (101.6 mm) **aluminium made**

As alternative:

**B046-03** Stability mould Ø 4" (101.6 mm), **steel made** 

**B047** Flow meter

**B047-01** Dial gauge for flow meter

**S370-08S** Load ring 30kN with electric stop safety device

**S374** Brake device to hold max. load

MARSHALL test Ø 6"

STANDARD: ASTM D5581

**S212-05** Load piston

**B046-02** Stability mould Ø 6"

**B047** Flow meter

**B047-01** Dial gauge for flow meter

**S370-10S** Load ring 50 kN with electric stop safety device

**S374** Brake device to hold max. load

**B046-02**

 **Note:** The frames S212M and S213-05N are suitable also for tensile splitting tests (EN 12697-23, ASTM D6931, AASHTO T283) by using the specific devices described on p. 123

## MULTIFUNCTION TESTING FRAMES:

COMBINED WITH "CYBER-PLUS 8 EVOLUTION", COMPUTERIZED DIGITAL DISPLAY SYSTEM

Technical Specifications:

The frame is the same as for the previous load frames (mod. S212N - S213-05N), but the load is measured by an electric 50kN cell with high precision strain transducers. The deformation (flow) is measured by a displacement transducer 50 mm stroke and  $\pm 0.1\%$  independent linearity. The **CYBER-PLUS 8 EVOLUTION** computerized multichannel digital display system (technical details: see mod. B044N-SET on p. 132), measures and displays at the same time load (stability) in kN and deformation (flow) in mm with peak hold features and possibility to print certificates and graphics directly on a laser printer via USB or to transfer them to PC via Ethernet.

### S214-05N KIT

#### CBR/MARSHALL 3 SPEED LOAD FRAME

DIGITAL TOUCH-SCREEN, COMPUTERIZED

Technical details of the frame: see mod. S213-05N, p. 494

Supplied complete with "Cyber-Plus 8 Evolution" system (B044N-SET, details on p. 000, Hardware details at p.19), load cell and displacement transducer, but **without** accessories to be ordered separately.

### S215A

#### UNIVERSAL MULTISPEED LOAD FRAME

DIGITAL, TOUCH-SCREEN, COMPUTERIZED

Technical Spec. of the frame: see mod. S212N at p. 494

Technical Spec. of S215A: see p. 19

Supplied **without** accessories for Marshall, CBR, Unconfined tests and Software, to be ordered separately.



**S214-05N KIT + MARSHALL accessories**

SOFTWARES FOR THE FRAMES COMBINED WITH "CYBER-PLUS 8" SYSTEM:

**B043-01N** SOFTWARE UTM2 (Universal Testing Machine 2)  
Licence for **MARSHALL** test.

Standards: EN 12697-34 | ASTM D6927, D5581, D1559

**B043-02N** SOFTWARE UTM2 (Universal Testing Machine 2)  
Licence for **TENSILE SPLITTING** test.

Standards: EN 12697-23 | ASTM D6931

Description and technical details of Software UTM2: see p. 18

**H009-01** PERSONAL COMPUTER, complete with LCD monitor 22", keyboard, mouse, connection cables, installation and setting up of the purchased software.

**C128** Laser printer, for the graphic and test certificate printing, to be connected directly to Cyber-Plus 8 through USB.

**C127N** On board graphic printer on thermo-paper

 **Note:** The frames S214-05N KIT and S215A are suitable also for tensile splitting and direct shear (Leutner) test, by using the specific devices described at p. 123

### ACCESSORIES for the frames, mod. S214-05N KIT and S215A

- S212-05** LOAD PISTON  
**B046N** STABILITY MOULD Ø 4" aluminium made, or  
**B046-03** STABILITY MOULD Ø 4" steel made   
**B046-02** STABILITY MOULD Ø 6" Standard: ASTM D5581

**S205N**
**UNITRONIC 50 KN  
 UNIVERSAL MULTIPURPOSE TOUCH-SCREEN FRAME  
 FOR COMPRESSION / FLEXURAL TESTS**

WITH AUTOMATIC LOAD OR DISPLACEMENT/DEFORMATION CONTROL, for testing:

- MARSHALL
- SPLITTING TENSILE
- DIRECT SHEAR (Leutner) on the connection between bituminous strata.
- SCB: Automatic Asphalt fracture test (see next page)

Soil:

- CBR (California Bearing Ratio),
- UNCONFINED COMPRESSION,
- QUICK TRIAXIAL

Concrete:

- FLEXURE ON BEAMS
- FLEXURE ON TILES

Cement:

- FLEXURE on 40x40x160mm specimens,
- COMPRESSION on cubes 40, 50, 70mm
- TENSILE on mortar briquettes (mod. S205-05N)

Metal, plastic, wires, ropes, textiles, papers etc.

- TENSILE TESTS, 25kN max capacity load (mod. S205-05N)

Clay blocks:

- PUNCHING

Rock and stones:

- UNIAXIAL SPLITTING TENSILE

**Technical features:**

By using suitable devices, Unitronic tester, within the limits of its max. 50 kN capacity for compression/flexural and 25 kN for tensile (see accessory S205-05N), performs compression, flexural, splitting tensile and direct tensile tests, with automatic load or displacement/deformation control.

The load is applied by a mechanical jack that is driven by a motor **brushless with closed loop through optic encoder** and controlled by a microprocessor. Stroke electric end switches are applied to the load piston to save the machine from accidental handlings.

The two crossheads foresee couplings to fix the different test devices (see accessories). The stress is measured by an electric load cell; the measurement and the displacement control of the crosshead is achieved by the electronic device incorporated into the machine.

**Firmware:**

- Electronic control unit "Cyber-plus Evolution" with Touch-Screen colour display, that runs like a standard PC based on Windows operating system.
- The machine can be connected to a PC for remote test execution through suitable Software.
- Direct connection to Intranet and Internet to establish a remote communication and receive an immediate diagnostic analysis from Matest technicians, or for updates of the software.
- Unlimited memory storage with: 2 USB ports, 1 SD card slot.
- RJ45 network connection
- Possibility to select different languages.



**S205N with load cell**

**TECHNICAL SPECIFICATIONS**

- Maximum compression capacity: 50kN
- Maximum tensile capacity: 25kN (accessory S205-05N)
- Adjustable testing speed from 0.01 to 51 mm/minute
- Adjustable pace rate from 1 to 15000N/sec.
- Max. ram travel: 100 mm
- Daylight between columns: 380 mm
- Max. vertical daylight: 850 mm
- Unitronic 50 kN is supplied without accessories and software to perform the specific tests that must be ordered separately (see accessories at next pages)

**Power supply:** 230V 1F 50-60Hz 1500W

**Dimensions:** 500x450x1450 mm

**Weight:** 130 kg approx

## SPECIFIC APPLICATIONS ON BITUMINOUS MATERIALS

### MARSHALL STABILITY TEST

STANDARDS: EN 12697-34 | ASTM D 6926, D5581, D1559  
AASHTO T245 | BS 598 :107 | NF P98-251-2  
Test development with displacement control.



#### NEEDED ACCESSORIES

- S337-34** Strain gauge load cell, 50 kN capacity.
- S212-05** Loading piston.
- B046N** Stability mould Ø 4" aluminium made.
- As alternative:
- B046-03** Stability mould Ø 4" steel made ASTM D6927 NEW
- B046-02** Stability mould Ø 6" steel made ASTM D5581
- B043-01N** Software for Marshall test.

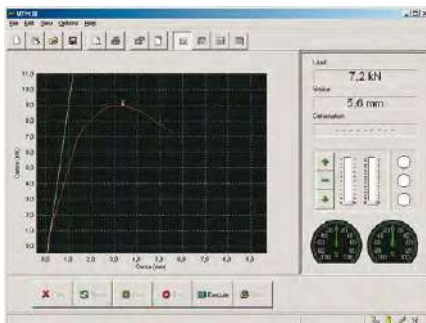

B043-01 Software Marshall test

### SPLITTING TENSILE TEST

STANDARDS: EN 12697-23 | ASTM D6931 | AASHTO T283 | CNR 134  
Test development with displacement control.



#### NEEDED ACCESSORIES

- S337-34** Strain gauge load cell, 50 kN capacity.
- S212-05** Loading piston.
- B047-02** Splitting tensile device for samples Ø 4" and 6"
- B047-04** Set of TWO displacement transducers with accessories.
- B043-02N** Software for Splitting Tensile test.

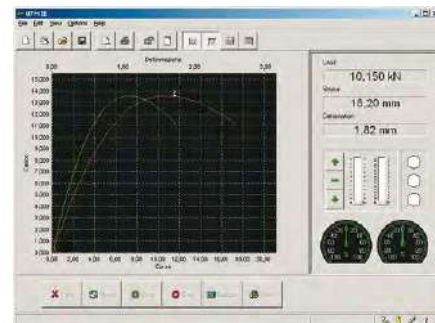

B043-02 Software splitting tensile test

### DIRECT SHEAR (LEUTNER) BETWEEN BITUMINOUS STRATA

STANDARD: ALP A StB T.80  
Direct shear test (LEUTNER) on the connection between bituminous strata, carried out on asphalt cylinder specimens Ø 150 mm or 100 mm obtained from road cores or on laboratory made specimens.  
Test development with displacement control.

#### NEEDED ACCESSORIES

- S337-34** Strain gauge load cell, 50 kN capacity.
- S212-05** Loading piston.
- B047-10** LEUTNER testing head for specimens Ø 150 mm.
- B047-11** Spacers for Ø 100 mm specimens with Leutner head.
- B043-03N** Software for Marshall and Leutner tests.



**Note:** Needed accessories listed above, are common for different tests. We recommend to check them when ordering, to avoid duplications. Additional specific applications described at p. 500



**S205N  
 AUTOMATIC SCB SYSTEM** ➤ NEW

THE FAST AND SIMPLE WAY TO PERFORM ASPHALT FRACTURE TESTING

STANDARDS: EN 12697-44 | AASHTO TP124 | ASTM D8044

The Automatic SCB system, used in conjunction with the S205N Unitronic 50 kN load frame, is an accurate device for conducting mechanical testing of asphalt mixtures. It can perform various versions of the Semi-Circular Bend (SCB) test for evaluating the fracture characteristics of asphalt mixtures at intermediate service temperature conditions. Pavement engineers can use these tests to determine the material characteristics needed for pavement design, quality control and/or quality assurance purposes.

Our Automatic SCB system is able to operate in load-control and displacement-control modes and can accommodate a wide range of test accessories in order to run several asphalt performance tests, including IDT/TSR, MARSHALL and DIRECT SHEAR.

In particular, Matest offers accessories for conducting SCB tests according to **EN 12697-44**, **AASHTO TP124** (recommended by University of Illinois) and **ASTM D8044** (recommended by Louisiana State University). The load and displacement parameters measured by the Automatic SCB system can be used to predict cracking performance of asphalt mixtures based on the Illinois Flexibility Index (I-FIT) and Critical Strain Energy Release Rate (Jc).



### MAIN FEATURES

- Precision load cell and LVDT for load and specimen vertical displacement measurement.
- Loading sequence fully automated with microprocessor control of the loading ram.
- Load and displacement measured with 8 analog A/D inputs.
- Touch screen display and intuitive controls allow for rapidly setting new test parameters and monitoring test data in real time.
- The data acquisition system can connect to multiple transducers simultaneously.
- The frame maintains the specimen alignment during the test.
- The durable electromechanical loading system needs minimal maintenance.
- Optional high quality Environmental Chamber performing tests between -25 °C and + 60 °C.

**S205N + SCB accessories**

### TECHNICAL SPECIFICATIONS

See the S205N unit technical specifications, at page 126, 500.

**S205N UNITRONIC 50KN CONFIGURATIONS:****EN 12697-44**

Tensile strength and fracture toughness-crack propagation.

**NEEDED ACCESSORIES**

- B250-01** Basic indirect tensile (idt) jig, for 100-150 mm diameter
- B254-01** Scb jig (requires basic idt jig)
- B254-51** Pair of scb wear plates
- S337-34** Load cell 50 kn capacity
- B045-13** Loading piston
- S336-15** Transducer type "B" travel: 10 mm
- B045-14** Coupling hardware
- S335-15** Universal coupling pliers for transd./dial
- B043-05N** Software for auto-scb test



Detail of the configuration



Asphalt specimen positioning

**AASHTO TP124**

Determining the fracture potential of asphalt mixtures using semicircular bend geometry (scb) at intermediate temperature.

**ASTM D8044**

Evaluation of asphalt mixture cracking resistance using the semi-circular bend test (SCB) at intermediate temperature.

**NEEDED ACCESSORIES**

- B208** SCB frame
- B254-02** Springs
- B254-10** Roller support
- S337-31(\*)** Load cell 2,5 kn capacity
- B045-13** Loading piston
- S336-15** Transducer type "B" travel: 10 mm
- B045-14** Coupling hardware
- S335-15** Universal coupling pliers for transd./dial
- B043-05N** Software for auto-scb test

**OPTIONAL ACCESSORIES**

- B254-12** Positioning device

(\*) As alternative to item S337-31

- S337-32** Load cell 10 kN capacity
- S337-33** Load cell 25 kN capacity
- S337-34** Load cell 50 kN capacity
- S337-35** Load cell 5 kN capacity



Detail of the configuration

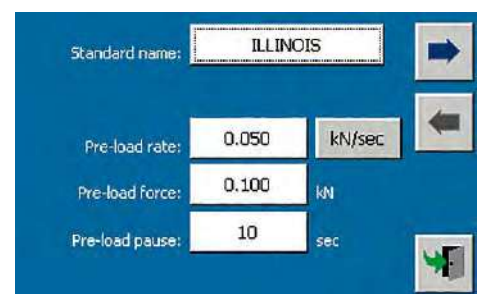

Software interface

## S206N UNITRONIC 200 KN MULTIPURPOSE TOUCH-SCREEN FRAME



FOR COMPRESSION, FLEXURE AND TENSILE TESTS,  
 WITH AUTOMATIC SERVO-CONTROLLED LOAD OR DISPLACEMENT  
 DEFORMATION CONTROL.

Unitronic 200kN is the universal and versatile machine designed and manufactured by Matest to satisfy the need of control, research and test on:

Roads (Marshall, Duriez, CBR etc.), Steel, Concrete, Cement, Wood, Plastic, etc.

The machine is composed of a sturdy base containing the transmission components and the hardware control instruments.

The base holds two columns, made of high resistance steel with ground hard chrome surfacing.

The upper crosshead can be adjusted in height, to hold the accessories to perform the specific tests.

The lower mobile crosshead is operated by a recirculating ball screw and rotating lead, that through a servo-controlled motor assures the correct application of load and constant speed.

The load is applied with a mechanical jack activated by a **brushless closed-loop motor with optical encoder** controlled by a micro-processor.

The two crossheads have couplings to fix the different test devices (see accessories).

The stress is measured by an electric load cell; the measurement and the displacement control of the crosshead is achieved by the electronic device incorporated into the machine.

Stroke electric end excursion switches of the upper mobile crosshead are foreseen to save the machine from accidental handlings.

### FIRMWARE:

- Electronic control unit **Cyber-plus Evolution** with Touch-Screen colour display, that runs like a standard PC based on Windows operating system for the management and analysis of the data, test results, graphs.
- The Touch-Screen icon interface allows an easy set up of the parameters and immediate execution of the test.
- The machine can be connected to a PC for remote test execution through suitable Software; the machine can in any case perform the tests without any external PC, because of the **Cyber-Plus** grants performances like a PC.
- Direct connection to Intranet (connection to a LAN network) and Internet to establish a remote communication and receive an immediate diagnostic analysis from Matest technicians, or for updates of the software.
- Unlimited memory storage with: 2 USB ports, 1 SD card slot, RS232/485 serial port.
- Possibility to select different languages.
- Hardware technical details: see p. 19



**S206N**

### SPECIFICATIONS OF THE FRAME:

- Max. load: 200 kN (both Compression and Tensile)
- Max. vertical daylight: 900 mm (without accessories)
- Max. vertical daylight with compression platens: 800 mm
- Compression platens diameter: 216 mm (upper platen on seat ball)
- Distance between columns: 650 mm
- Crosshead travel:  $\pm 200$  mm (400 mm total)
- Testing speed range: from 0.01 to 100 mm/min
- Load rate: from 1 N/s to 5 kN/s
- Displacement resolution: 0.01 mm with accuracy better than 0.2%
- Machine Class: 1

The Unitronic 200 kN is **supplied complete with:** Electric load cell 200 kN capacity, crosshead displacement device, upper with seat ball and lower compression platens.

**Are not included:** accessories and software for specific tests that must be ordered separately (see accessories).

**Power supply:** 230V 1ph 50-60Hz 850W

**Dimensions:** 950x560x2400 mm

**Weight:** 820 kg approx.

### Note:

The machine can be equipped with intermediate load cells to the max. capacity of the machine, to satisfy specific test requirements.

## SPECIFIC APPLICATIONS:

**DURIEZ TEST SET**

STANDARD: NF P98 - 251-1, NF P98 - 251-4

Used to determine the mechanical and physical properties of bituminous mixtures. To perform the test, the specimens have to be temperature conditioned using a suitable climatic chamber (see mod. C313, p. 348)

**S206N** Unitronic 200 kN  
**S206-21N** Software for Duriez test

Duriez test set for 120 mm diameter specimens:

**B095-01** Testing mould  
**B095-02** Penetration piston  
**B095-03\*** Penetration piston grooved  
**B095-04** Upper/Lower piston  
**B095-05\*** Upper/Lower piston grooved  
**B095-06** Two temporary supports  
**B095-07** Demoulding cylindrical container

Duriez test set for 80 mm diameter specimens:

**B096-01** Testing mould  
**B096-02** Penetration piston  
**B096-03\*** Penetration piston grooved  
**B096-04** Upper/Lower piston  
**B096-05\*** Upper/Lower piston grooved  
**B096-06** Two temporary supports  
**B096-07** Demoulding cylindrical container

\* Used for cold mixtures with bituminous emulsions

**B095-01...B095-07****DIRECT SHEAR (LEUTNER) BETWEEN BITUMINOUS STRATA**

STANDARD: ALP A StB T.80

Direct shear test (LEUTNER) on the connection between bituminous strata, carried out on asphalt cylinder specimens  $\varnothing$  150 mm or 100 mm obtained from road cores or on laboratory made specimens.

**S206N** Unitronic 200 kN  
**S337-34** Strain gauge load cell 50 kN capacity  
**S206-31** Flange/connector of the load cell S337-34  
**S212-05** Loading piston  
**B047-10** LEUTNER testing head for specimens  $\varnothing$  150 mm  
**B047-11** Spacers for  $\varnothing$  100 mm specimens with Leutner head  
**B043-03N** Software for Leutner and Marshall tests.

Additional specific accessories for tests on:

Concrete and Mortar (compression, flexure, punching etc.) - Soils (CBR) - Steels (Tensile), are listed in soil section, p. 508.

**MARSHALL STABILITY TEST**STANDARDS: EN 12697-34 | ASTM D6927, D5581, D1559  
AASHTO T245 | BS 598:107 | NF P98-251-2

**S206N** Unitronic 200 kN  
**S337-34** Strain gauge load cell 50 kN capacity  
**S206-31** Flange/connector of the load cell S337-34  
**S212-05** Loading piston  
**B046N** Stability mould  $\varnothing$  4" aluminium made

As alternative:

**B046-03** Stability mould  $\varnothing$  4" steel made. ASTM D6927 **NEW**  
**B046-02** Stability mould  $\varnothing$  6" steel made. ASTM D5581  
**B043-01N** Software for Marshall test

**NEW****B046-03****B046-02 + B047 + B047-01****B046N****SPLITTING TENSILE TEST**

STANDARDS: EN 12697-23 | ASTM D6931 | AASHTO T283 | CNR 134

**S206N** Unitronic 200 kN  
**S337-34** Strain gauge load cell 50 kN capacity  
**S206-31** Flange/connector of the load cell S337-34  
**S212-05** Loading piston  
**B047-02** Splitting tensile device for samples  $\varnothing$  4" and 6" (p. 121)  
**B047-04** Set of TWO displacement transducers with accessories (p. 123)  
**B043-02N** Software for Splitting Tensile test (p. 18)

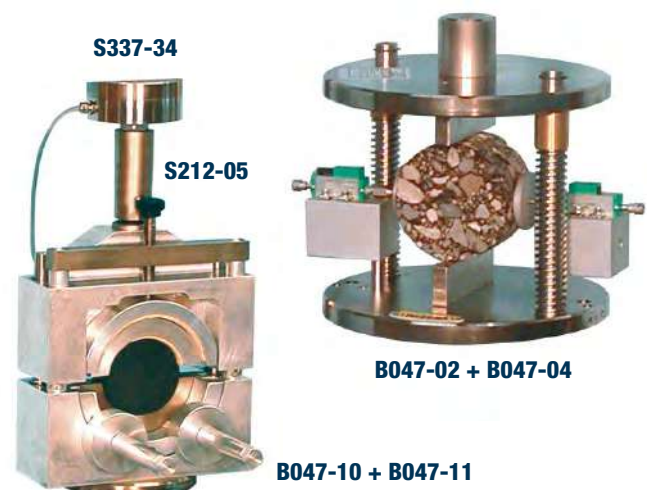
**S337-34****S212-05****B047-02 + B047-04****B047-10 + B047-11**

## B044N-SET CYBER-PLUS 8 EVOLUTION TOUCH-SCREEN

Developed for the implementation and upgrading of any type of existing machines (even not manufactured by Matest) applicable to:

- Marshall mechanical load frame mod. B042 KIT.
- CBR/Marshall 3 speeds load frame mod. S213-05N.
- CBR loading machine motorized mod. S211 KIT.

Suitable to perform the following tests:

- MARSHALL: EN 12697-34 | ASTM D6927, D5581, D1559  
CNR N. 30 | NF P98-251-2 | BS 598 :107  
AASHTO T245
- INDIRECT TENSILE TEST: EN 12697-23, EN 12697-12  
ASTM D6931, D4123 | AASHTO T283
- DETERMINATION OF THE WATER SENSIBILITY OF BITUMINOUS SPECIMENS: EN 12697-12
- CBR TEST: EN 13286-47 | CNR | UNI 10009 | AASHTO T193  
ASTM D1883 | BS 1377:4 | NF P94-078.
- UNCONFINED TEST: ASTM D2166

### MAIN FEATURES

- Acquisition and data processing system up to 8 analogical/digital channels.
- Remote control through PC and UTM2 software.
- Graphic display 1/4 VGA color Touch-Screen.
- Instant display of load and deformation.
- Automatic correction of the axis origin and automatic calculation of all the results.
- Safety switch-off at max reached load and/or deformation.



**B044N SET**

#### HARDWARE SPECIFICATIONS

- 8 independent channels available for the load cells or potentiometric transducers for load, or displacement measurements;
- Stabilized power supply of the analogical channels: 5 Vcc and 3 Vcc;
- Analogue input:  $\pm 20$  mV and  $\pm 5$  V;
- Nominal resolution: 24 bit;
- Acquisition up to 200 readings for each channel;
- Safety discrete On/off output;
- Graphic display 1/4 VGA colour Touch-Screen;
- Time and calendar system.

#### FIRMWARE SPECIFICATIONS

- Instant visualization of the load measured by an extensometric cell.
- Instant visualization of the deformation measured by 4 linear displacement transducers.
- Visualization of the graphic of the test.

- Visualization of date and time.
- Semi-automatic configuration and calibration of all transducers connected.
- 20 steps lining that can be set by the enduser.
- Automatic correction of the axis origin for CBR/Marshall tests.
- Setting of all the parameters for test: alarms, zero threshold, end-test percentage, calculation parameters.
- Time/date and language selection (Italian, English, French, German, Spanish, Polish).
- Unlimited file for each type of test
- Symbols of pushbuttons functions
- Informative messages (planning alarms, load cell and strain transducer setting, etc.)
- Printing of the results on the incorporated thermal graphic printer (accessory C127N). Transfer and management via Ethernet of the filed data or real-time.

Hardware technical details: see p. 19

**B044N-SET** is composed of:

### B044N CYBER-PLUS 8 EVOLUTION

Unit for data acquisition.

Power supply: 230V 1F 50-60Hz.

### S337-34 LOAD CELL

50kN capacity, with high precision strain transducers, complete with cable and connector.

### S336-14 LINEAR DISPLACEMENT TRANSDUCER

50 mm stroke, independent linearity  $\pm 0.1\%$  complete with cable and connector.

All necessary accessories for fixing the load cell and transducer to the test machine, are provided.

The system is calibrated ready to use and COMPLETE with a calibration certificate.

Every item can be ordered separately.

## ACCESSORIES

### B043-01N

SOFTWARE UTM2 (Universal Testing Machine 2)

Licence for **MARSHALL** test

Data processing program for **X-Y STABILITY/FLOW**

STANDARDS: EN 12697-34 | ASTM D6927, D5581, D1559  
BS 598:107 | NF P98-251-2

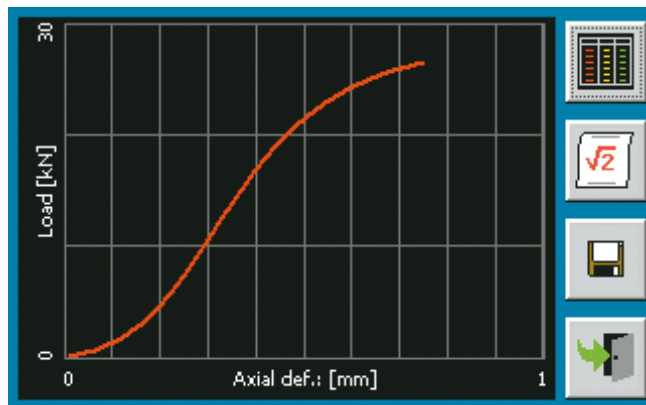

Example of Marshall stability/flow graph

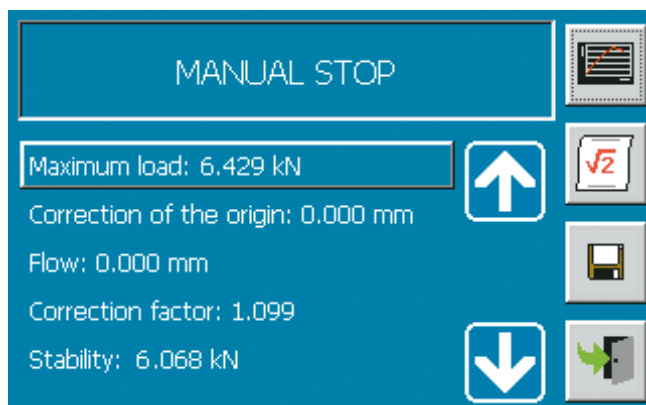

Real time display of final results

### B043-02N

SOFTWARE UTM2 (Universal Testing Machine 2)

Licence for **INDIRECT TENSILE STRENGTH**

STANDARDS: EN 12697-23 | ASTM D6931 | AASHTO T283



Selection of test method on touch-screen panel



Real time results during test

### S218N

SOFTWARE UTM2 (Universal Testing Machine 2)

Licence for **CBR** Test

STANDARDS: EN 13286-47 | UNI CNR 10009 | ASTM D1883  
BS 1377:4 | NF P94-078 | AASHTO T193

### S218-01N

SOFTWARE UTM2 (Universal Testing Machine 2)

Licence for **UNCONFINED** Test

STANDARDS: ASTM D2166

Description and technical details of Software UTM2: see p. 18

### H009-01

PERSONAL COMPUTER, complete with LCD monitor 22", keyboard, mouse, connection cables, installation and setting up of the purchased software.

### C128

LASER PRINTER for test certificate and graphics printing with direct connection to CYBER-PLUS 8.

**C127N** On board graphic printer on thermo-paper

## WATER BATHS FOR MARSHALL SPECIMENS

STANDARDS: EN 12697-34 | ASTM D6927, D1559, D5581 | AASHTO T245

Used to maintain in water Marshall specimens at constant temperature of  $60\text{ }^{\circ}\text{C} \pm 1\text{ }^{\circ}\text{C}$  and asphalt specimens at  $37.8\text{ }^{\circ}\text{C} \pm 1\text{ }^{\circ}\text{C}$ .

These baths are also ideal for general laboratory use.

### MODELS

#### B051 MARSHALL WATER BATH

The internal tank and cover are stainless steel made, outside box is of painted steel sheet with wool insulation. The specimens are held by a stainless steel perforated shelf spaced from the bottom.

The bath has a capacity of 46 litres and is designed to hold up to 20 Marshall specimens.

Temperature range: from ambient to  $95\text{ }^{\circ}\text{C}$ .

Inside dimensions: 615x505x150 mm

Overall dimensions: 660x540x230 mm

The bath is supplied **without** thermostat and heating element to be ordered separately (see accessories).

**Weight:** 18 kg approx.



**B051**



**B051 + B051-01**

### NEEDED ACCESSORY for the B051 Bath

#### B051-01

THERMOSTAT ANALOGIC Heating System, complete with immersion heating element.

**Power supply:** 230V 1ph 50-60Hz 1500W

In alternative:

#### B051-02

THERMOSTAT DIGITAL Heating System, complete with immersion heating element. The digital system ensures a better temperature control of the water at  $60 \pm 1\text{ }^{\circ}\text{C}$  or  $37.8 \pm 1\text{ }^{\circ}\text{C}$  as requested by Standards.

**Power supply:** 230V 1ph 50-60Hz 1500W



**C306-03**



**B051-01**

**B051-02**

#### C306-03

SEPARATE CONTROL PANEL, complete with switch and electrical protections to get B051-01 and B051-02 thermostats to CE safety Directive.

## B052 DIGITAL WATER BATH

This bath is fully double walled stainless steel made with wool insulation. The specimens are held by a shelf spaced out from the bottom. Complete with a digital thermostat and an electric stirrer for **continuous water recirculation**, ensuring a constant and uniform temperature of  $60 \pm 1 \text{ }^\circ\text{C}$  or  $37.8 \pm 1 \text{ }^\circ\text{C}$  as prescribed by the Standards.

The bath can hold up to 20 Marshall specimens

Capacity: 60 litres

Temperature range: from ambient to  $95 \text{ }^\circ\text{C}$

The bath is equipped with a dual safety thermostat to prevent accidental over-heatings.

**Inside dimensions:** 700x550x150 mm

**Outside dimensions:** 950x660x360 mm

**Power supply:** 230V 1ph 50-60Hz 1500W

**Weight:** 20 kg approx.

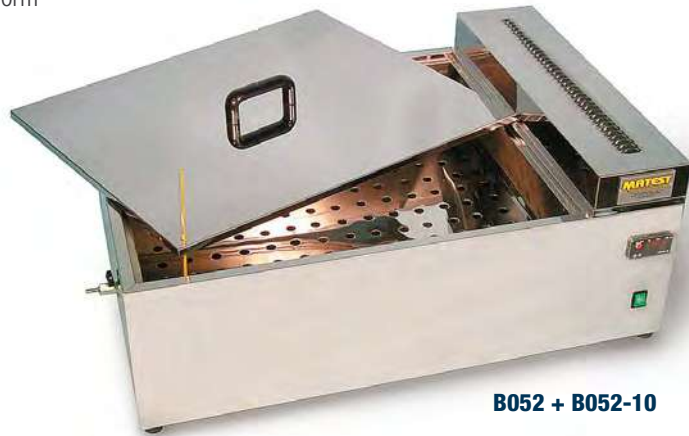

**B052 + B052-10**

## B052-01 DIGITAL WATER BATH

Identical to mod. B052 but:

Inside dimensions: 430x420x160 mm

Outside dimensions: 620x500x330 mm

The bath can hold up to 9 Marshall specimens

**Capacity:** 30 litres

**Power Supply:** 230V 1ph 50-60 Hz 1200W

**Weight:** 15 kg approx.

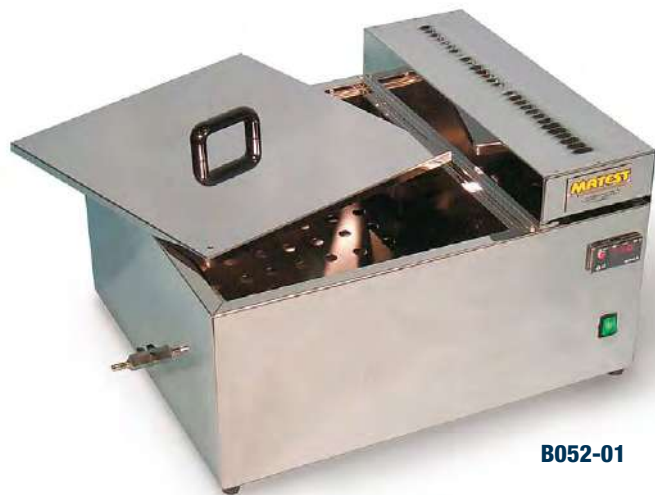

**B052-01**

## E136-01 DIGITAL WATER BATH

Identical to mod. B052 but:

Inside dimensions: 900x600x360 mm

Outside dimensions: 1050x680x630 mm

The bath can hold up to 80 Marshall specimens

**Capacity:** 200 litres

**Power Supply:** 230V 1ph 50-60 Hz 4000W

**Weight:** 55 kg approx.



**B052-02**

## B052-02 DIGITAL WATER BATH WITH COOLING DEVICE

Similar to mod. B052 but equipped with cooling unit placed under the bath for controlling water temperatures where the ambient temperature is quite higher.

Temperature range from:  $+ 3$  to  $+ 95 \text{ }^\circ\text{C}$ , accuracy:  $\pm 1 \text{ }^\circ\text{C}$ .

The bath can hold up to 12 Marshall specimens

Capacity: 45 litres

**Inside dimensions:** 635x360x205 mm

**Outside dimensions:** 800x430x1000 mm

**Power supply:** 230V 1ph 50Hz 1650W

**Weight:** 60 kg approx

### ACCESSORY FOR MOD. B051...B052-02

**B052-10** ALCOOL CONTROL THERMOMETER 0-100  $^\circ\text{C}$  subd. 1  $^\circ\text{C}$



## B053-10 COHESION TESTER

STANDARDS: ISSA TB139, comparable to EN 12274-4 | ASTM D3910

This instrument is used for cohesion tests on the mix, and to determine the proper consistency or mix design for a slurry seal mixture. The pneumatic cylinder incorporated into the unit applies a pressure to the sample. A hand torque tester supplied with the cohesion unit, measures the torquing strength by determining the complete solidification of the mix.

Supplied complete with torque wrench, 5 moulds Ø 60x6 mm, 5 moulds Ø 60x10 mm, 5 moulds Ø 70x6 mm, 5 moulds Ø 70x10 mm accessories, spare parts.

To perform the test an air pressure source is needed.

**Dimensions:** 400x250x300 mm approx.

**Weight:** 20 kg approx

### ACCESSORIES

**V206** AIR COMPRESSOR. 230V 50Hz 1ph.

SQUARE MOULD to EN 12274-4 with 4 holes to prepare the sample:

**B053-12** MOULD 140x140x6.3 mm

**B053-13** MOULD 140x140x10 mm

**B053-14** MOULD 200x200x13 mm

**B053-15** MOULD 200x200x19 mm

### SPARES

**B053-16** MOULD Ø 60x6 mm (2 pieces)

**B053-17** MOULD Ø 60x10 mm (2 pieces)

**B053-18** MOULD Ø 70x6 mm (2 pieces)

**B053-19** MOULD Ø 70x10 mm (2 pieces)

## B053

### “VIALIT” BINDER ADHESION TEST

STANDARDS: EN 12272-3 | NF P98-274-1

Used to evaluate the global adhesion and the active adhesion between bitumen and aggregates for road surfaces realization.

The equipment is formed by:

Six metal test plates

Steel ball weighing 512 g

Metallic base with three

vertical support points and

metallic rod 500 mm high

Metallic hand operated roller,

rubber lined with lead shots ballast.

**Weight:** 40 kg approx.

**SPARE: B053-01** Metal test plate.



## S148

### SAND ABSORPTION CONE AND TAMPER

#### CONSISTENCY DETERMINATION

STANDARDS: EN 12274-3, EN 1097-6

Used for the determination of the absorption and specific gravity of fine aggregates.

**Weight:** 600 g approx.



## B053-10



## B053-20

### PLANETARY ABRASION TESTER

#### DETERMINATION OF WEARING

STANDARDS: EN 12274-5 | ASTM D3910 | NLT 320

The unit consists of a planetary mixer in which container the slurry mixture is placed and a weighted special headed rubber hose applies an abrasion action.

**Power supply:** 230V 1ph 50Hz

**Dimensions:** 340x460x500 mm approx.

**Weight:** 40 kg approx.

### NEEDED ACCESSORIES

**B053-22** SET OF 4 ROUND METALLIC MOULDS  
Ø 279-295 ± 0.5 mm  
Heights: 6.3 - 10 - 13 - 19 mm to EN 12274-5 Spec.

**B053-23** SET OF 3 ROUND METALLIC MOULDS  
Ø 279-295 ± 0.5 mm  
Heights: 6.3 - 8.2 - 10.5 mm to ASTM D3910 Spec.



**B053-20**

## B053-05

### RATE OF SPREAD DEVICE

STANDARDS: EN 12272-1 | BS 598:108

This apparatus is used for determining the rate of spread of coated chippings on the road surface.

The device consists of a 300 mm square tray, lifted by 4 chains which are fixed on a spring balance.

The rate of spread is directly measured in kg/m<sup>2</sup>.

**Weight:** 1500 g approx.



**B053-05**

# SECTION B

ASPHALT | BITUMEN | PAVETEST



Bituminous mixture, also known as asphalt mixture, is mainly composed by aggregates and bitumen, an infinite variety of mixtures being possible. This section is divided into three parts and shows the whole range of equipment for analyzing each component of the bituminous mixture.

**ASPHALT.** The first part is dedicated to the asphalt testing machines used to provide a solution for the whole “asphaltic path”: mixing, compacting, modelling and testing. The equipment meets the needs of those who want to perform quality control or experimentation of new asphalt mixtures.

**BITUMEN.** This section shows equipment required for bitumen testing: these include machines to study the rheological properties of bitumen as well as the features of bituminous emulsion. The last part of this section provides better solutions to perform field tests on road surface.

**PAVETEST.** Pavetest’s range of pavement dynamic testing systems both complements and completes Matest’s Asphalt and Bitumen business unit. All our products comply with the principal international standards.



**B059M**  
**SMARTIP**  
**FULLY AUTOMATIC PENETROMETER**

STANDARDS: EN 1426 | ASTM D5 | AASHTO T49 | ASTM D217 | BS 1377-2 | NF T66-004 | DIN 52210 | IP 49 | JIS K 2207

SMARTIP is an automatic apparatus for the determination of the needle penetration value, avoiding any possible operator lack of concentration and ensuring a reliable repeatability of the results. It is a smart instrument thanks to the latest technologies adopted, the integrated microprocessor control and the user-friendly interface.

The instrument automatically reaches the contact point before starting the test and the penetration result is measured thanks to a high performance contactless displacement transducer. SMARTIP can be implemented with the device for an automatic measurement of electrically conductive samples (model B059M-01), in order to improve the material tested range. An ultra-bright LED lamp helps the operator in checking the touching point of the needle while a stepper motor controls the vertical movement to reach exactly the desired point without any manual movement of the plunger. The needle probe is automatically released for each penetration thanks to an electromagnetic system and automatically blocked at the end of the test.

The plunger comes back at the initial position at the end of each test by a simple recall command in order to re-positioning the needle before the new measurement.

A 7" touch screen display is included in the SMARTIP frame, easy to use. It shows in real time the penetration/time graph, the test temperature and the average result according to the number of tests done. Unlimited results can be saved on USB device for preparing a laboratory report and for further analysis.

SMARTIP is supplied complete with the accessories for determination of the needle penetration according to EN 1426, ASTM D5 and AASHTO T49 standards, and USB flash drive for saving data. Thermostatically controlled water bath, chiller, temperature probe PT100, device for an automatic measurement of electrically conductive samples and mirror can be ordered separately as accessories.

**MAIN FEATURES**

- Fully automatic test, simply pressing the START button: approach, touch point, penetration.
- Automatic identification of the needle contact point and needle positioning, avoiding any possible operator lack of concentration and ensuring a reliable repeatability of the results.
- Electro-magnetic needle probe release to perform the test.
- Automatic zero at the contact before starting penetration.
- Penetration measurement thanks to a high-tech contactless displacement transducer with 0.01 mm resolution, in a range of 0 - 50 mm.
- 7" touch screen display equipped with an user-friendly software and clear interface.
- Real time display of penetration/time curve, average result and test temperature.

**B059M-01**  
**SMARTIP**

Same as B059M but implemented with device for testing electrically conductive samples.

**B059M**

## TECHNICAL SPECIFICATION

- Measuring range: 0 – 50 mm;
- Resolution: 0,01 mm;
- 7" touch screen display;
- Test time 5 s (adjustable from 0 to 9999 s);
- Programmable delay time: from 0 to 999 s;
- Programmable reference positions for holder assembly: 8;
- Test simultaneously displayed: up to 10;
- Connection: USB port and LAN port for PC connection;

**Power supply:** 110-230V 50-60Hz 1ph

**Overall dimensions:** 325x400x730 mm

**Weight approx.:** 25 Kg approx.



**B058M**



**B058**

**B058-01**



**B058-01**

## ACCESSORY

**B058** THERMOSTATICALLY controlled water bath.  
Technical details: see p. 142

**B058-01** WATER BATH DISH with incorporated thermostatic coil, to be connected to the bath mod. B058. It keeps the temperature of the bitumen sample directly on the penetrometer, by avoiding to transfer it.  
Dimensions Ø 151x90 mm

**B058M** WATER CHILLER: 7.5 l capacity, with electronic temperature controller with  $\pm 0.1$  °C accuracy and fluid temperature range between 5 and 30°C. Suitable for chilling penetrometer water baths or temperature controlled setting time tests

- 230 V 50-60Hz 1ph
- Power consumption: 350 W
- Overall dimensions: 415x300x420 mm
- Weight: 15 kg approx.

**B059M-11** TEMPERATURE PROBE, PT100: Measurement of the sample temperature in real time. It's connected with the monitor in order to show the temperature during each test, to collect the data at the end of penetration and to include the temperature data in the final reading

**B057-08** THERMOMETER, IP 38C

**B057-06** PENETRATION NEEDLE conforming to EN 1426 and ASTM D5, supplied with official UKAS certificate

**B057-07L** LONG NEEDLE hardened

**B057-03** GLASS TRANSFER DISH

**B056-09** PENETRATION BALL

**B057-09** STANDARD PENETRATION CONE conforming to ASTM D217 and EN 13880-2



## SPARES for B059M

**V122-05** Sample cup 55x35 mm

**V122-06** Sample cup 70x45 mm

**B057-07** PENETRATION NEEDLE, individually verified

**B057-04N** 50 g weight

**B057-05N** 100 g weight

## B056 KIT STANDARD DIAL PENETROMETER

STANDARDS: EN 1426 | ASTM D5 | BS 1377-2 | NF T66-004  
AASHTO T49

Used to determine the consistency of a bituminous sample under fixed conditions of load, time and temperature. The penetration is expressed in distance of tenths of millimeters vertically penetrated by a standard needle. The standard penetrometer has a sturdy aluminium base table with levelling screws, plated vertical rod, **micrometric vertical adjustment device**.

The slider is brass made with free fall. The dial, graduated in 360° (division 0.1 mm), has a diameter of 150 mm.

The penetrometer is supplied with stop and release push button, automatic zero set, micrometer adjustment, set of weights 50 and 100 g penetration needle, brass sample cups Ø 55x35 mm and 70x45 mm.

**Dimensions:** 220x170x410 mm.

**Weight:** 11 kg approx.

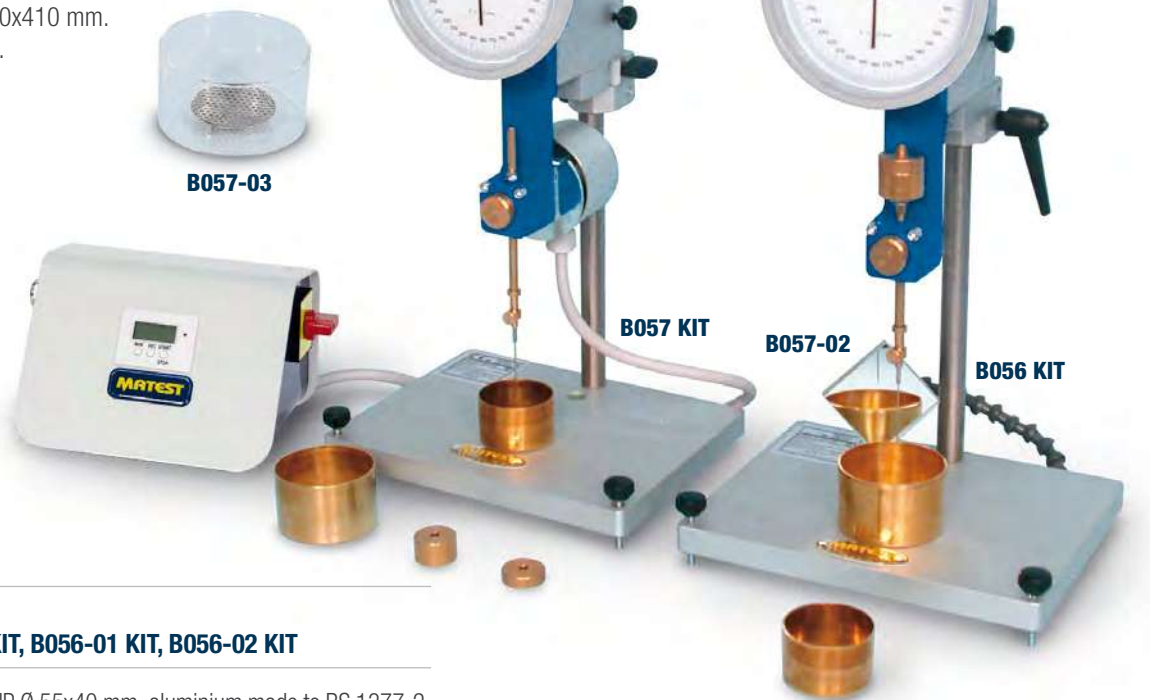

### ACCESSORIES

for B056 KIT, B057 KIT, B056-01 KIT, B056-02 KIT

**V122-08** SAMPLE CUP Ø 55x40 mm, aluminium made to BS 1377-2.

**B057-02** MIRROR, for an easier setting of the needle.

**B057-03** TRANSFER DISH, made of glass, with support.

**B057-06** PENETRATION NEEDLE HARDENED STEEL, 42.5 ± 2.5 mm long supplied with UKAS Verification Certificate.  
Weight: 2.5 ± 0.05 g

**B057-07** PENETRATION NEEDLE HARDENED STEEL, 42.5 ± 2.5 mm long. Each needle is individually verified with engraved serial number, and perfectly meets EN 1426 Specification. Weight: 2.5 ± 0.05 g

**B057-01L** LONG PENETRATION NEEDLE, not hardened, **NEW** 52.5 ± 2.5 mm. Comparable to EN, to test specimens where the penetration is expected to exceed 35 mm

**B057-07L** LONG PENETRATION NEEDLE HARDENED, **NEW** 52.5 ± 2.5 mm to EN 1426, to test specimens where the penetration is expected to exceed 35 mm

**B057-08** THERMOMETER, IP 38C Range: +23 °C to +26 °C.  
Grad. 0.1 °C

**B089** THERMOMETER, EN, Range: +19 °C to +27 °C.  
Grad. 0.1 °C - ASTM 17C

## B057 KIT AUTOMATIC DIAL PENETROMETER

Basically structured as mod. B056 KIT but having a magnetic controller device with electronic digital programmable timer that automatically releases the plunger head and ensures free falling of the needle during the 5-seconds test.

**Power supply:** 230V 1ph 50-60Hz 200W

**Dimensions:** 220x280x410 mm

**Weight:** 15 kg approx.

### SPARES for B056 KIT, B057 KIT, B056-01 KIT, B056-02 KIT

**B057-01** Penetration needle, not hardened, 42.5 ± 2.5 mm long.  
Comparable to EN Spec. Weight: 2.5 ± 0.05 g

**B057-04** 50 g weight.

**B057-05** 100 g weight.

**V122-05** Sample cup, brass made, Ø 55x35 mm

**V122-06** Sample cup, brass made, Ø 70x45 mm



## B056-01 KIT STANDARD DIGITAL PENETROMETER

STANDARDS: EN 1426 | ASTM D5 | BS 1377-2 | NF T66-004  
AASHTO T49

Used to determine the consistency of a bituminous sample under fixed conditions of load, time and temperature. The penetration is expressed in distance of tenths of millimeters vertically penetrated by a standard needle. The standard penetrometer is ruggedly constructed, with an aluminium base table with levelling screws, plated vertical rod, **micrometric vertical adjustment device**.

The slider is brass made with free fall.

The digital readout of the penetration values has readings in mm and inch, with 0.01 mm resolution, LCD 5 digits display, with zero set in any position.

Power: 1.5V battery.

The penetrometer is supplied with stop and release push button, automatic zero set, micrometer adjustment, set of weights 50 and 100 g penetration needle, brass sample cups Ø 55x35 mm and 70x45 mm.

**Dimensions:** 220x170x410 mm

**Weight:** 11 kg approx.



## B056-02 KIT AUTOMATIC DIGITAL PENETROMETER

Basically structured as mod. B056-01 KIT but having a magnetic controller device with electronic digital programmable timer that automatically releases the plunger head and ensures free falling of the needle during the 5-seconds test.

**Power supply:** 230V 1ph 50-60Hz 200W

**Dimensions:** 220x280x410 mm

**Weight:** 15 kg approx.

### ACCESSORIES

for B056 KIT, B057 KIT, B056-01 KIT, B056-02 KIT

**B056-09** PENETRATION BALL. Hot applied joint sealants.  
 Test method for the determination of penetration and recovery (resilience).  
 STANDARD: EN 13880-3

**B057-09** STANDARD PENETRATION CONE Ø 65 mm for measuring the consistency of lubricating grease.  
 Brass body and steel point made. Weight: 102.5 g  
 STANDARDS: EN 13880-2 | ASTM D217 | IP 179  
 ISO 2137 | DIN 51804



B057-09

B056-09

## B016 AIR BATH

Used for softening bitumen before performing a range of tests including ductility, flash point, penetration, loss on heating. Inner vessel, stainless steel made, has 600 g capacity. Complete with thermoregulator, pilot lamp.

**Power supply:** 230V 1ph 50-60Hz 500W

**Dimensions:** 140x140x350 mm

**Weight:** 5 kg approx.



B016



### B058 THERMOSTATICALLY CONTROLLED WATER BATH FOR PENETROMETER

Provides water at the required temperature of  $25 \pm 0.1$  °C. The unit consists of a stainless steel water bath 10 litres capacity with wool insulation, immersion heater with digital thermostat, motor pump with connections, cooling coil device, current water operated, to maintain a constant temperature of the bath when room temperature is slightly higher. The bituminous sample is immersed into the water bath, and placed on the penetrometer only at the time of the test, by eventually using the transfer dish (accessory mod. B057-03).

**Power supply:** 230V 1ph 50-60Hz 350W

**Dimensions:** 375x335x420 mm

**Weight:** 12 kg approx.



B058 detail

#### ACCESSORY

##### B058-01

WATER BATH DISH with incorporated thermostatic coil, to be connected to the bath mod. B058. It keeps the temperature of the bitumen sample directly on the penetrometer, by avoiding to transfer it. Dimensions  $\varnothing$  151x90 mm

### B060 BACON SAMPLER

STANDARDS: EN 58 | CNR N° 81, N° 98  
ASTM D140 | AASHTO T40

Used to obtain asphalt or oil samples from various levels within a storage tank by the "thief" method. Made from brass. Capacity 237 ml

**Dimensions:**  $\varnothing$  50x250 mm

**Weight:** 2 kg approx.



B060

### B090 BREAKING VALUE OF CATIONIC BITUMEN EMULSIONS: MINERAL FILLER METHOD

STANDARDS: EN 13075-1 | IP 494

Equipment for the determination of the breaking value of cationic emulsions, (manual version) comprising: Filler feeding pan, complete with support base and clamp, nickel spatula, two round porcelain dishes.

**Weight:** 2 kg approx.



#### ACCESSORIES for Automatic Version

**B090-10** ELECTRIC STIRRER having 260 rpm, 230V 50-60Hz 1ph

**S157-06** SUPPORT BASE for stirrer.

**B090-11** PROPELLER for electric stirrer.

**B090-12** METALLIC CONTAINER, 500 ml capacity.

**B090-19** REFERENCE FILLER, original Forshammar, recommended by EN Spec. Bucket of 10 kg

**B090-20N** REFERENCE FILLER, 25 kg where  $\text{SiO}_2$  content and Volumetric Mass conform to EN 13075-1; while grading composition does not conform.

## B063-10 PARTICLE CHARGE TESTER

### PARTICLE POLARITY OF BITUMEN EMULSIONS

STANDARDS: EN 1430 | ASTM D244 | CNR N. 99

This apparatus is used to identify the particle charge of bitumen emulsions.

The equipment comprises:

- Milliammeter scale up to 10 mA on support base
- Variable resistor
- Two stainless steel electrodes
- Insulating device
- Beaker 250 ml capacity to EN spec.
- Glass rod

**Power supply:** 250V 1ph 50-60Hz

**Dimensions:** 200x200x600 mm

**Weight:** 3 kg approx.



**B063-10**

## ACCESSORY

### B063-11

BEAKER 500 ml capacity to ASTM spec.

## B072-20 WILHELMI SOFTENING POINT APPARATUS

STANDARDS: EN 1871 | DIN 1996-15

Used for determining the softening point of bituminous materials for road construction, according to Wilhelmi method.

The softening point is the temperature where a layer of thermoplastic material has a deformation given by a steel sphere weighting 13.9 g. The apparatus comprises a ring divided in two halves on a metal support frame, glass beaker, steel ball 15 mm diameter.

**Weight:** 2 kg approx.



**B072-20 + B072-02**

## ACCESSORIES for B072-20

### B072-02

THERMOMETER, ASTM 16C, scale +30 °C +200 °C, subd. 0.5 °C.

### B073-02

ELECTRIC HEATER WITH MAGNETIC STIRRER, suitable for still water and glycerine tests, with softening point up to 150 °C.

**Power supply:** 230V 1ph 50-60Hz 700W

**Weight:** 4 kg approx.

See p. 150

## B063 KIT EMULSIFIED ASPHALT DISTILLATION APPARATUS

STANDARDS: EN 1431 | ASTM D 244 | AASHTO T 59 | CNR N° 100

Used for the determination of cut-back asphaltic materials by the distillation test. The set is formed by: aluminium still container, glass connectors including condenser, stands, graduated cylinder, two thermometers ASTM 7C range -2 to +300 °C, gas ring burner with gas stop valve controlled by a flame sensor.

It can be sold on CE markets, but not usable in closed spaces.

**Weight:** 12 kg approx.

## SPARE

**B063-01** Thermometer -2 to +300 °C ASTM 7C



**B063 KIT**

## B063-05 STORAGE STABILITY OF ASPHALT EMULSIONS

STANDARD: NF T66-022

This apparatus is used for the determination of the storage stability of emulsions by decantation. It consists of a 12V current stabilized source, cylindrical electrode, base with holder, stainless steel vessel 500 ml capacity, watch glass.

**Power supply:**

230V 1ph 50-60Hz

**Dimensions:** 200x200x500 mm

**Weight:** 5 kg approx.



**B063-05**



## B054 DUCTILOMETER

STANDARDS: EN 13398, EN 13589 | ASTM D113, D6084 | AASHTO T51

Used to determine the bituminous ductility, that is the distance to which a briquette of molten bitumen can be extended under controlled conditions, before breaking. The Ductilometer basically consists of a moving carriage travelling along guide ways. The carriage is driven by an electrical motor, inside a large tank fitted with digital thermostat, immersion electric heater, cooling coil for cold water circulation and pump unit. Max. traction force: 300 N, accuracy:  $\pm 0.1$  N

The ductilometer can accept up to 3 specimens simultaneously. Supplied complete **except** for the briquette mould and base plate that must be ordered separately (see accessories).

**Power supply:** 230V 1ph 50Hz 750W

**Dimensions:** 1880x360x680 mm

**Weight:** 95 kg approx.

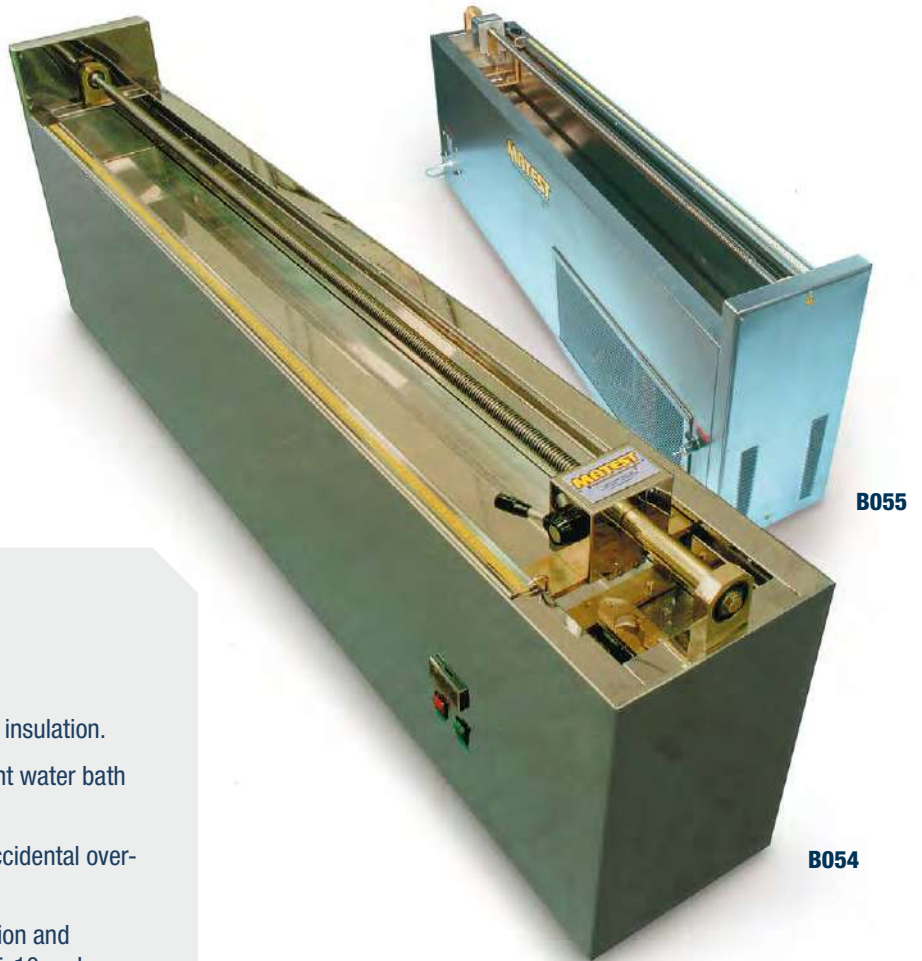

### MAIN FEATURES

- Works automatically.
- Speed 50 mm/min.
- Max stroke 1500 mm.
- Stainless steel made with fibreglass insulation.
- Digital thermoregulator for a constant water bath temperature ( $25\text{ }^{\circ}\text{C} \pm 0.5\text{ }^{\circ}\text{C}$ ).
- Dual safety thermostat to prevent accidental over-temperature.
- Cyber-plus 8 evolution data acquisition and processing system available in B055-10 and B055-20N models.

### ACCESSORIES

#### B054-01

DUCTILITY BRIQUETTE MOULD - STANDARDS: ASTM, AASHTO, GOST  
Used to prepare the specimen, it is brass made, accurately machined. Supplied without base plate. Weight: 300 g

#### B054-03

DUCTILITY BRIQUETTE MOULD - STANDARD: EN 13398  
Used to prepare the specimen, it is brass made, accurately machined. Supplied without base plate. Weight: 300 g

#### B054-04

DUCTILITY BRIQUETTE MOULD - STANDARD: EN 13589  
Used to prepare the specimen, it is brass made, accurately machined. Supplied without base plate. Weight: 300 g

**B054-02** BASE PLATE for ductility briquette mould.

#### B055 DUCTILOMETER WITH COOLING SYSTEM

Same as for mod. B054 but equipped with incorporated refrigerating unit for tests with water temperature from  $+ 5^{\circ}$  to  $+ 25^{\circ}\text{C}$ .

**Dimensions:** 1880x360x680 mm

**Weight:** 130 kg approx.

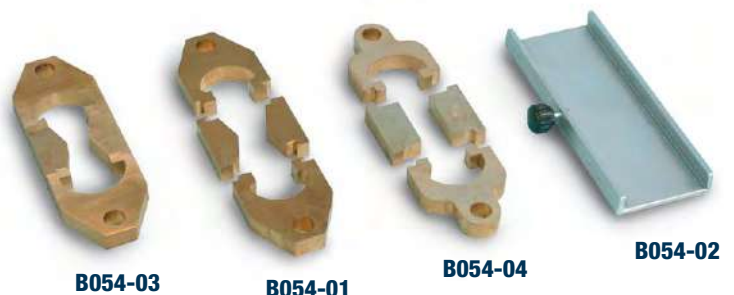

## B055-10 DUCTILOMETER WITH DATA ACQUISITION HIGH PERFORMANCE

STANDARDS: EN 13398 | EN 13589 | EN 13703 | ASTM D113, D6084 | AASHTO T51 | GOST 11505-75, 33138-2014

Same as mod. B054, but upgraded with:

- Cyber-plus Progress data acquisition and processing system, **colour touch screen display** ¼ VGA, 24 bit resolution. It automatically performs data acquisition and processing. Directly connected to printer (accessory) via USB it prints the test certificate. Equipped with slots for external pendrive or SD card infinite memory support with direct connection to PC. Hardware details: see p. 19, 225
- Software UTM NET to unload and visualize test data to PC.
- One electric load cell 50 N capacity complete with installation and calibration. (Possibility to install later on up to 3 cells directly by the end user). Supplied **without** briquette mould and base (see accessories).



### ACCESSORIES

#### B055-15

LOAD CELL electric, 50 N capacity, complete with installation and calibration (possibility to install up to 3 cells).

#### B055-16

REFRIGERATING UNIT, incorporated into the machine, for tests with water temperature from +5 °C to +25 °C (not possible to fix on later).

Ductility moulds and base plate: see p. 144



B055-10

B055-20N

## B055-20N DUCTILOMETER WITH DATA ACQUISITION FOR RESEARCH HIGH PERFORMANCE

STANDARDS: EN 13589, 13703, 13398 | ASTM D113, D6084  
AASHTO T51, T300, T301  
GOST 11505-75, 33138-2014

Developed and manufactured for ductility tests and for research purposes. Stepper motor providing a variable speed range from 1 to 400 mm/min with digital displacement measuring system.

Up to 3 samples can be tested simultaneously.

One electric high capacity load cell 500 N (possibility to install later on up to 3 cells directly by the end user).

Automatic positioning of start test.

Visualization of the elongation in mm and load/elongation chart.

Max elongation recording before breaking failure.

Absorbed energy elaboration.

Temperature setting and visualization of the test execution with continuous recording during the test.

Test certificate print-out (USB connector or local printer).

Cyber-plus Progress data acquisition and processing system **colour touch screen display** (technical details: p. 19, 225).

Software UTM2 to unload and display test data to PC.

Glass upper cover.

Supplied **without** briquette mould and base (see accessories).

**Power supply:** 230V 1ph 50-60Hz 1000W

**Dimensions:** 2140x400x650 mm

**Weight:** 110 kg approx.

### ACCESSORIES

#### B055-15

LOAD CELL electric, 50 N capacity, complete with installation and calibration, suitable for soft bitumen.

#### B055-25

LOAD CELL electric, 500 N capacity, complete with installation and calibration (possibility to install up to 3 cells).

#### B055-26

REFRIGERATING UNIT, incorporated into the machine, for tests with water temperature from +5 °C to +25 °C. (Not possible to fix later on).

#### C128

LASER PRINTER, bench model, for graphics and certificates with direct connection via USB.

Ductility moulds and base plate: see p. 144



Detail: 3 load cells 500 N

## CALIBRATION EQUIPMENT FOR DUCTILOMETERS WITH DATA ACQUISITION

### AVAILABLE MODELS

#### B055-27 KIT CALIBRATION EQUIPMENT FOR MOD. B055-10

Consisting of:

##### C138M UNIVERSAL DIGITAL TESTER WITH MICROPROCESSOR

This user friendly menu driven digital display, connected to the calibration load cell, allows to perform an accuracy's verification of the loads measured from the Ductilometer under control, and it allows to produce the relative certificate.

Technical details: see p. 326

##### B055-30 CALIBRATION LOAD CELL

Electric, 50 N capacity, complete with installation devices.

### TECHNICAL SPECIFICATIONS

- Full Scale nominal output: 2 mV/V
- Linearity + Hysteresis:
- $\pm 0.1\%$  of full scale
- Repeatability:  $\pm 0.03\%$  of full scale
- CLASS: AA

##### B055-34 ADAPTER

Coupling device between the load cell and the ductilometer



**B055-28 KIT**

### NEEDED ACCESSORY

**C138-05** CALIBRATION PROCESS of the load cell combined with the Universal digital tester, complete with Matest Calibration Certificate.

Alternative:

**C138-10** CALIBRATION CERTIFICATE issued by an accredited Calibration Institute (ACCREDIA Centre)

#### B055-28 KIT CALIBRATION EQUIPMENT FOR MOD. B055-20N

Consisting of:

##### C138M UNIVERSAL DIGITAL TESTER WITH MICROPROCESSOR

This user friendly menu driven digital display, connected to the calibration load cell, allows to perform an accuracy's verification of the loads measured from the Ductilometer under control, and it allows to produce the relative certificate.

Technical details: see p. 326

##### B055-32 CALIBRATION LOAD CELL

Electric, 500 N capacity, complete with installation devices.

### TECHNICAL SPECIFICATIONS

- Full Scale nominal output: 2 mV/V
- Linearity + Hysteresis:
- $\pm 0.1\%$  of full scale
- Repeatability:  $\pm 0.03\%$  of full scale
- CLASS: AA

##### B055-35 ADAPTER

Coupling device between the load cell and the ductilometer

#### B077 KIT FRAASS APPARATUS BREAKING POINT STANDARD: EN 12593

This apparatus is used to determine the breaking point of semisolid and solid bitumes. It consists in a flexure device with two concentric sliding resin tubes, jaws for the test specimen, flexure system with handle, cooling device with three containers, plate in special harmonic steel, thermometer IP 42C.

**Weight:** 4 kg approx.

### SPARES

**B077-01** Plate (spring) in special armonic steel

**B077-02** Thermometer IP 42C



**B077 KIT**

#### HUBBARD-CARMICK SPECIFIC GRAVITY

STANDARDS: EN ISO 3838 | ASTM D70  
NF T66-007

**V111** Cylindrical type, 24 ml

**V111-01** Conical type, 25 ml



**V111-01**

**V111**

## B075 WATER IN BITUMEN EMULSIONS

STANDARDS: EN 1428, 12847 | ASTM D244 | NF T66-023

Used to determine the water in petroleum products or bituminous materials, by distilling them with a water immiscible, volatile solvent.

The equipment comprises:

- Glass balloon 500 ml
- Glass receiver 25 ml capacity with 0.1 ml grad.
- Glass reflux condenser

Electric heater with thermoregulator, clamps.

**Power supply:** 230V 1ph 50Hz 500W

**Weight:** 8 kg approx.



**B075**

## B076 WATER IN BITUMINOUS MATERIALS (DEAN-STARK)

STANDARDS: ASTM D95, D244  
AASHTO T55 | IP 74-77  
CNR No. 101 | NLT 123

Identical to mod. B075 except for the receiver having 10 ml capacity.

## BITUMINOUS EMULSIONS RESIDUE ON SIEVING

STANDARD: EN 1429

**B076-21** Sieve, stainless steel, Ø 75 mm, 0.5 mm opening

**B076-22** Sieve, stainless steel, Ø 75 mm, 0.16 mm opening

**B076-24** Pan and Cover, stainless steel, Ø 75 mm.

STANDARD: ASTM D6935-17

**B076-25** Sieve, stainless steel, Ø 75 mm, 0.18 mm opening

**B076-26** Sieve, stainless steel, Ø 75 mm, 1.4 mm opening



**B076-21...B076-26**

## BITUMINOUS EMULSIONS MIXING STABILITY WITH CEMENT

STANDARD: EN 12848

**B076-23** Sieve, stainless steel, Ø 75 mm, 2 mm opening

**B076-22** Sieve, stainless steel, Ø 75 mm, 0.16 mm opening

**B076-24** Pan and Cover, stainless steel, Ø 75 mm.

## B079N CABINET WITH ASPIRATOR

Double aspiration system, certified to EN 14175-2-3 Bureau Veritas.

Used to exhaust vapors and toxic solvents caused by Centrifuge Extractors, Hot Extractors etc., by avoiding they are diffused in the laboratory. Metal frame, monolithic stoneware, 4 sockets + switch, water spout and cock, electric aspirator, electric lighting.

The front transparent door can be lifted by vertical counterweights for an easy access to the operation desk.

**Power supply:** 230V 1ph 50-60Hz

**Dimensions:** 1800x830x2500 mm

**Weight:** 380 kg approx.



**B079-01**

**B079N**

### ACCESSORY

#### B079-01

LOWER CUPBOARDS, bilaminated plastic made, complete with doors and shelves.

## B069 KIT DISTILLATION OF CUT-BACK ASPHALTS, ELECTRIC

STANDARDS: ASTM D402 | AASHTO T78 | NF T66-003  
UNE 7112, 7072

Used to measure the amount of the most volatile constituents in cut-back asphaltic products.

The apparatus consists of: electric heater with thermoregulator, distillation flask, condenser tube, adapter, shield, receiver, supports, graduated cylinder, thermometer ASTM 8C -2 to +400 °C, subd.1 °C

**Power supply:** 230V 1ph 50-60Hz 600W

**Weight:** 12 kg approx.



**B069 KIT**

### SPARE

**B069-11** Thermometer -2 +400 °C sudd. 1 °C, ASTM 8C

## EFFECT OF HEAT AND AIR ON A MOVING FILM OF ASPHALT

### B066M KIT ROLLING THIN-FILM OVEN HIGH PERFORMANCE

STANDARDS: EN 12607-1 | ASTM D2872 | AASHTO T240

New model with enhanced performance and reliable technology needed to study the aging phenomena on traditional and innovative bituminous binders.

The frame and the internal chamber are made of high quality stainless steel with a large door to detect the test room.

This new version is totally controlled by 7" digital touch-screen panel in terms of test temperatures, start and stop carriage rotation and ventilation system.

Also, when the test starts, the internal room temperature, the air flow and the carriage speed (15 rpm  $\pm$  0.2) are shown in real time on the digital display.

Supplied complete with digital flow meter, precision digital thermostat to maintain 163 °C temperature, control thermometer ASTM 13C, ventilation device, eight glass containers  $\varnothing$  64x140 mm. The unit includes a dual safety thermostat to prevent overheating.

**Power supply:** 230V 1ph 50-60Hz 1700W

**Dimensions:** 620x620x910 mm

**Weight:** 55 kg approx.



**B066N KIT** closed door

### B066N KIT ROLLING THIN-FILM OVEN RTFOT | ASTM | EN

STANDARDS: EN 12607-1 | ASTM D2872 | AASHTO T240

Used to measure the air and heat effect on a moving film of asphaltic semisolid materials. External frame and internal chamber are stainless steel made with insulated fiberglass intermediate chamber. Rotation speed of the plate: 15 rpm  $\pm$  0.2.

Provided with a large glass door for inspections. The oven must be connected to an air compressor 2 bar max. pressure, or to a diaphragm pump (see accessory). Supplied complete with flow meter, precision digital thermostat to maintain 163 °C temperature, control thermometer ASTM 13C,

ventilation device, eight glass containers  $\varnothing$  64x140 mm.

The oven is equipped with a dual safety thermostat to prevent accidental over-heatings.

**Power supply:** 230V 1ph 50Hz 1700W

**Dimensions:** 620x620x910 mm

**Weight:** 55 kg approx.

### MAIN FEATURES

- 7" Touch-screen color display.
- Temperature ramp designed to achieve the target temperature within 10 minutes when the door is closed.
- Flow meter range: from 200 to 14.000 ml/min.
- Temperature accuracy  $\pm$  0.1 °C when the target temperature test is achieved.



**B066M KIT** open door with touch screen display



**B066-02N**

### ACCESSORY

#### B066-11N

Portable compressor, including pressure reducer for precise delivery pressure setting. Very low-noise, ideally for indoor use 59db. Max pressure 8 bar, 6 litres air reserve.

**Power supply:** 230V 50Hz



**B066-11N**

### SPARES

**B066-02N** Glass container  $\varnothing$  64x140 mm, top quality product with improved finishing.

**B064-03** Thermometer, ASTM 13C.  
 Range: +155 °C to +170 °C div. 0.5 °C.

## B064 KIT ROTATING SHELF THIN FILM OVEN

DETERMINATION OF LOSS IN MASS AND RESISTANCE TO HARDENING (TFOT)

STANDARDS: EN 12607-2, EN 13303 | CNR N° 50 | ASTM D6, D1754 | AASHTO T47, T179 | BS 2000 | UNE 7110 | NF T66-011

Internal chamber and external frame all made of stainless steel, double wall insulation with fiberglass, double door. Temperature control by digital thermoregulator. The oven is equipped of a dual safety thermostat to prevent accidental over-heatings. The plate rotates at 5-6 rpm. Supplied complete with glass control thermometer ASTM 13C, +155 to +170 °C subd 0.5 °C.

The oven is supplied **without rotating shelf and accessories**, that must be ordered separately.

**Power supply:** 230V 1ph 50Hz 1500W

**Internal dimensions:** 330x330x330 mm

**Outside dimensions:** 460x450x700 mm

**Weight:** 40 kg approx.



**B064 KIT + B064-01 KIT**  
open door

The oven mod. B064 kit can be equipped in two versions, with the following accessories:

### B064-01 KIT

Rotating shelf complete with 9 containers Ø 55x35 mm for the **Determination of Loss on Heating** to: EN 13303 | ASTM D 6 BS 2000 | NF T066-011 | AASHTO T47 | CNR N° 50 NF T066-011 | AASHTO T47 Standards.

### B064-02

Rotating shelf, complete with 2 containers Ø 140x9.5 mm for the **Determination of Thin Film** to: EN 12607-2 | ASTM D1754 AASHTO T149 | UNE 7110 Standards.

As alternative

### B064-02 SP

Rotating shelf, same as B064-02, but complete with 4 containers.



**B064 KIT + B064-02**  
closed door



**B064-02**

**B064-01 KIT**



**B064-02SP**

### SPARES

**V122-05** Brass container Ø 55x35 mm

**B064-04** Stainless steel container Ø 140x9.5 mm

## B072 RING AND BALL SOFTENING POINT APPARATUS

STANDARDS: EN 1427 | ASTM D36 | AASHTO T53 | NF T66-008  
 Comparable to: BS 2000 | UNI 4161 | DIN 52011 | UNE 7111

The softness of bitumen depends, amongst other factors, on the substance temperature, the more the temperature increases, the more increases the softness of the bitumen.

The unit consists of a pyrex beaker, brass frame, two tapered rings, two ball centering guides and two balls.

**Weight:** 900 gr

### ACCESSORIES

**B072-01** THERMOMETER ASTM 15 C -2 to +80 °C subd. 0.2 °C

**B072-02** THERMOMETER ASTM 16 C +30 to +200 °C subd. 0.5 °C



### B072-07 POURING PLATE

Used to pour the bituminous mixture into the brass tapered ring, as required by EN 1427 Specification.

**Dimensions:** 75x50x10 mm

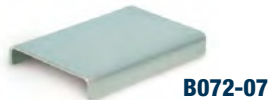

### B074 HOT PLATE

Complete with thermoregulator for temperature adjustment.

**Power supply:** 230V 1ph 50-60Hz 1000W

**Weight:** 6 kg approx.

### ACCESSORY for B074

#### B074-01

ELECTRIC STIRRER, ensures a more uniform temperature to the bath. Supplied complete with vertical support and base.

**Power supply:** 230V 1ph 50Hz 100W

**Weight:** 3 kg approx.

As alternative:

#### B073-01

HOT PLATE WITH MAGNETIC STIRRER

Complete with thermoregulator for temperature adjustment and magnetic stirrer with electronic adjustment from 100 to 1200 rpm. Suitable for tests in distilled water with softening point between +30 °C to +80 °C.

**Power supply:** 230V 1ph 50-60Hz 700W

**Weight:** 4 kg approx.

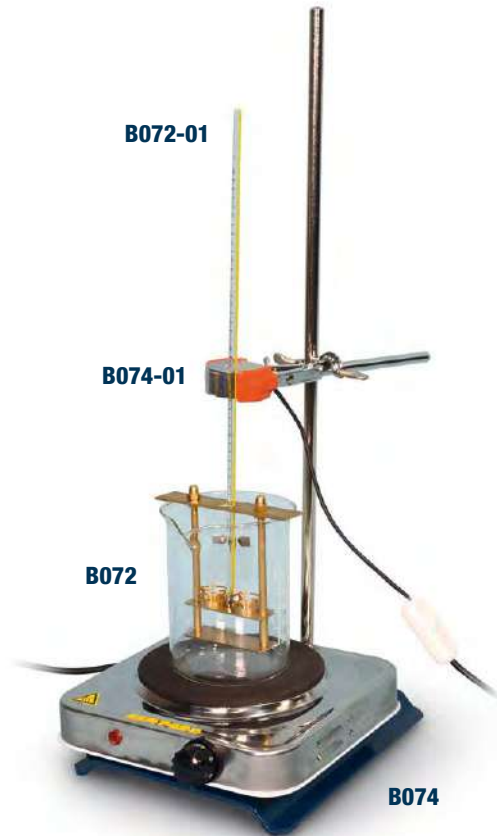

As alternative:

### B073-02 HOT PLATE WITH MAGNETIC STIRRER

Same as mod. B073-01, but with more powerful electric heating resistance, suitable **also** for tests in glycerine with softening point over +80 °C up to +150 °C.

**Power supply:** 230V 1ph 50-60Hz 700W

**Weight:** 4 kg approx.

### SPARES for B072

**B072-03** Steel ball Ø 9.5 mm

**B072-04** Brass tapered ring

**B072-05** Ball centering guide

**B072-06** Pyrex beaker



## B070M SOFTMATIC AUTOMATIC DIGITAL RING AND BALL APPARATUS

STANDARDS: EN 1427 | ASTM D36 | AASHTO T53 | NF T66-008;  
comparable to: BS 2000 | DIN 52011 | UNE 7111  
UNI 4161 | CNR N.35

This high technology digital microprocessor tester, designed and manufactured by Matest, automatically determines the softening point of asphalts and pitches.

Two laser sensors detect the balls fall determining the softening point.

The bath temperature is measured by an electronic system maintaining the gradient (5 °C/min) as specified by the Standards.

A magnetic stirrer with electronic speed adjustment from 0 to 160 rpm also ensures a uniform temperature in the vessel during the test execution.

**The cooling system enables to quickly cool down the samples, allowing to perform many more tests per day.**

The **touch-screen** graphical interface allows an easy set up of the parameters and the immediate execution of the test.

High resolution color display, 800x480 pixel, offers all the functions of a PC for the management and analysis of data, test results, and graphs.

Two test parameters can be selected in the microprocessor menu:  
- test on boiled distilled water for softening point from 30 to 80 °C.  
- test on glycerol for softening point from 80 up to 150 °C.

The tester is basically composed of:

- Ceramic-glass heating plate with automatic cut off at the end of the test cycle.
- Motherboard with microprocessor, which controls: heater/stirrer, temperature probe, laser sensors, pre-heating phase of the plate, and memorizes all the test parameters.
- Steel balls centering device.

**Power supply:** 230V 1ph 50-60Hz 700W

**Dimensions:** 435x330xh510 mm

**Weight:** 20 kg approx.



Test execution

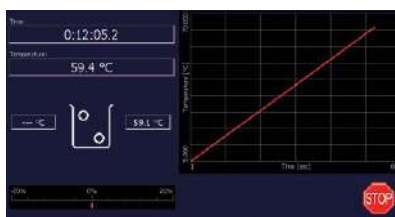

Temperature-Time graph

### ACCESSORY

#### B070-11

RODS WITH SPHERICAL ENDS (set of 2 pieces)  
for checking and calibration of the instrument.



B070M

### MAIN FEATURES

- Real time display of the Temperature (°C)-Time(sec) graph along the entire test.
- Touch-screen TFT LCD graphic display, 800x480 pixels, 7 inches.
- Unlimited memory (USB pendrive, internal Micro SD) editable data via PC.
- Multilanguage selection.
- Microprocessor friendly-driven menu to control all the test phases.
- Top quality components: laser sensors, electronic magnetic stirrer, ceramic-glass heating plate.
- Fully automatic.

### SPARES

- B072-03** Steel ball 9.5 mm diameter
- B070-15** Brass tapered ring, chromed
- B070-16** Brass centering guide, chromed
- B070-17** Pyrex beaker





**B065**
**ROTOVAPOR**
**ROTARY EVAPORATION APPARATUS**

BITUMINOUS BINDERS. RESISTANCE OF HARDENING. ROTATING FLASK TEST: RFT METHOD

STANDARD: EN 12607-3

This unit is used to evaluate the hardening effect of a treated bituminous binder sample. The test is performed by putting 100 g of bituminous binder into the rotating flask. The sample is heated at 165°C and ambient temperature air is blown into the flask containing the binder hardening the same. The hardening effect is evaluated according to penetration, viscosity and softening point tests.

The Rotary Evaporation Apparatus is essentially composed of:

distillation flask 1000 ml capacity rotated by a speed motor at an adjustable rate between 10 and 280 rpm, condenser, solvent recovery flask, heated oil bath.

The angle of the rotary/distillation flask is 15°

The instrument is supplied complete with glass tubing with three way valves and transparent flexible hose for solution intake.

The Rotatory Apparatus requires a vacuum pump and a vacuum regulating system (see accessories at p. 84).

**Power supply:** 230V 1ph 50-60Hz

**Dimensions:** 740x430x845 mm

**Weight:** 15 kg approx.

**B065**
**B075-05**
**SOLUBILITY OF BITUMINOUS BINDERS**

STANDARDS: EN 12592 | ASTM D2042

The set comprises :

Gooch crucible complete with funnel and rubber ring.

Filter flask 500 ml capacity with rubber stopper.

Whatman filter discs, Ø 25 mm (pack of 100)

**Weight:** 1000 g approx.

BITUMEN EMULSIONS:

**B075-01**
**GRADUATED CYLINDER WITH SIDE TUBES AND STOPPER**

DETERMINATION OF SETTLING TENDENCY

STANDARDS: EN 12847 | IP 485

The cylinder has 600 ml capacity, it is marked at 500 ml and two side tubes are foreseen.

**Weight:** 800 g approx.

**Note:** To perform this test the water in petroleum emulsion, equipment mod. B075 is also required. See p. 147

**B075-08**
**GLASS TUBE WITH GLASS FILTER**

DETERMINATION OF PENETRATION POWER

STANDARDS: EN 12849 | IP 487

The glass tube has 41.5 mm inside diameter by 115 mm height, and a fused-on glass filter with holes size between 0.160 and 0.250 mm is fitted.

**Weight:** 300 g approx.

**B075-05**

**B075-01**
**B075-08**

## B080 ENGLER DIGITAL VISCOMETER

STANDARDS: ASTM D 490, D 1665 | AASHTO T54 | BS 2000  
NF T66-020 | CNR N° 102

Used to compare the specific viscosity of road-oils and tars to the viscosity of water. It consists of a water bath complete with digital precision thermoregulator, electric stirrer, cooling device, Engler flask. The viscometer is equipped of a dual safety thermostat to prevent accidental over-temperatures.

### Power supply:

230V 1ph 50Hz 300W

### Dimensions:

265x270x550 mm

**Weight:** 12 kg approx.



**B080 + B082-01**

## B081 ENGLER DIGITAL VISCOMETER TWO ELEMENTS

Basically structured as mod. B080 but having **Two elements**, electrically operated, supplied complete.

**Weight:** 20 kg approx.

### ACCESSORIES for Engler

**B082-01** THERMOMETER ASTM 23 C range +18 +28 °C  
subd. 0.2 °C

**B082-02** THERMOMETER ASTM 24 C range +39 +54 °C  
subd. 0.2 °C

**B082-03** THERMOMETER ASTM 25 C range +95 +105 °C  
subd. 0.2 °C

**B082-04** THERMOMETER NF T66 -020 range 0-55 °C.  
subd. 0.2 °C

**B082-06** KOHLRAUSH CALIBRATION FLASK 200 ml capacity

**B082-07** FILTER SCREEN, ASTM N°50

**B082-05** SPARE Engler testing flask

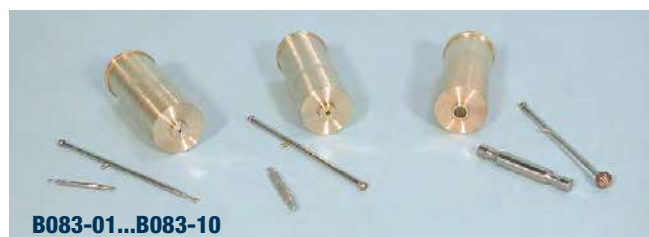

**B083-01...B083-10**

## B084-01 KIT STANDARD TAR (BRTA, REDWOOD) DIGITAL VISCOMETER

STANDARDS: EN 12846-01, EN 12846-02, EN 13357 | IP 184  
NF T66-005

Used to determine the viscosity of cut-back bitumen and road oil. The instrument consists of a stainless steel bath (tank), agitator, rheostat, immersion electric heater with digital thermostat to take the water to the desired temperature, cooling coil for water supply connection. The viscometer is equipped of a dual safety thermostat to prevent accidental over-temperatures.

Supplied with control glass thermometer IP 8C, range 0 - 45 °C, subd. 0.2 °C, graduated glass cylinder 100 ml capacity.

Supplied **without** Cup, Go/not go gauge, ball valve to be ordered separately (see accessories).

**Power supply:** 230V 50-60Hz 1ph 300W

**Dimensions:** 265 x 270 x 550 mm

**Weight:** 12 kg approx.

## B084-02 KIT TWO PLACES TAR VISCOMETER, DIGITAL

Basically structured as mod. B084-01 KIT,  
but having **TWO ELEMENTS**

### ACCESSORIES for Standard TAR

Standards: EN, NF, IP

**B083-01** Go/not go gauge for Ø 4 mm orifice

**B083-02** Cup with orifice Ø 4 mm

**B083-03** Ball valve Ø 4 mm

Standards: EN, NF, IP

**B083-04** Go/not go gauge for Ø 10 mm orifice

**B083-05** Cup with orifice Ø 10 mm

**B083-06** Ball valve Ø 10 mm

Standard: EN 12846-02

**B083-08** Go/not go gauge for Ø 2 mm orifice

**B083-09** Cup with orifice Ø 2 mm

**B083-10** Ball valve Ø 2 mm

### SPARES

#### B083-07

Thermometer IP 8C,  
range 0 - 45 °C,  
subd. 0.2 °C.

#### V101-03

Graduated cylinder, glass,  
100 ml capacity.



**B084-01 KIT  
+ accessories**

## B086 KIT CLEVELAND OPEN CAP FLASH AND FIRE POINT TESTER

STANDARDS: EN 22592 | ASTM D92 | AASHTO T48  
IP 36 | NF T60-118 | ISO 2592

Used to measure the flash and fire points of lubricated oils and petroleum products.

Complete with brass cup, thermometer IP 28C (ASTM 11C) range -6 +400 °C, electric heater with thermoregulator, double line fuse. Supplied **without** flame gas device to be ordered separately.

**Power supply:** 230V 1ph 50-60Hz 600W

**Dimensions:** 220x285x265 mm approx.

**Weight:** 10 kg approx.

### NEEDED ACCESSORY

#### B086-02

FLAME GAS device, complete with gas-stop valve controlled by a flame sensor and maximum thermostat with reset button. It can be sold in CE markets, but not usable in closed spaces.

### SPARE

**B086-10** Thermometer IP 28C (ASTM 11C), range -6 +400 °C.

## B087 SAYBOLT DIGITAL VISCOMETER

STANDARDS: ASTM D88 | AASHTO T72

Used to determine the viscosity of petroleum products at specified temperatures between 70 to 210 °F. Stainless steel made, the Saybolt viscometer is supplied complete with two interchangeable orifices **Furol** and **Universal**, oil bath, electric heater with digital thermoregulator, stirrer, cooling coil, viscosity flask. Thermometers, filter funnel, withdrawal tube **are not included** and must be ordered separately. The viscometer is equipped of a dual safety thermostat to prevent accidental over-heatings.

**Power supply:** 230V 1ph 50-60Hz 500W

**Dimensions:** 280x260x510 mm

**Weight:** 12 kg approx.

### ACCESSORIES

Saybolt Thermometers	Range	Subd.
<b>B089</b> ASTM 17C	+19 a +27 °C	0.1 °C
<b>B089-01</b> ASTM 18C	+34 a +42 °C	0.1 °C
<b>B089-02</b> ASTM 19C	+49 a +57 °C	0.1 °C
<b>B089-03</b> ASTM 20C	+57 a +65 °C	0.1 °C
<b>B089-04</b> ASTM 21C	+79 a +87 °C	0.1 °C
<b>B089-05</b> ASTM 22C	+95 a +103 °C	0.1 °C

#### B087-11

FILTER FUNNEL complete with wire filter ring mesh.



**B087-11**

#### B087-12

WITHDRAWAL TUBE complete.

**B087-12**

### SPARES for SAYBOLT

**B089-06** Furol orifice

**B089-07** Universal orifice

**B089-08** Saybolt flask 60 ml capacity



**B086-02**

**B086 KIT**

## B087-01 TWO TUBE SAYBOLT VISCOMETER

Basically structured as mod. B087 but with two tubes. Supplied complete except thermometers, filter funnel and withdrawal tube.

**Dimensions:** 270x270x550 mm approx.

**Weight:** 14 kg approx.



**B087-01**

## B092 KIT TAG CLOSED-CUP VISCOMETER. FLASH POINT

STANDARDS: ASTM D56 | API 509

Suitable for testing volatile flammable flashing between 0 and 175 °F (except fuel oils).

Supplied complete with cup, water bath, lid, slide, thermoregulated electronic heating device, thermometer ASTM 9C range -5 to +110 °C and thermometer ASTM 57 C range -20 to +50 °C.

The tester is equipped of a gas flame feeder.

**Power supply:** 230V 1ph 50Hz 700W

**Dimensions:** 200x300x400 mm approx.

**Weight:** 10 kg approx.



**B092 KIT**

## B093 KIT TAG OPEN-CUP VISCOMETER. FLASH POINT

STANDARDS: ASTM D1310, D 3143

For the determination of open cup flash points of volatile flammable materials having flash points between 0 and 175 °F

Supplied complete with cup, water bath, thermoregulated electronic heating device, thermometers ASTM 9C -5 to +110 °C and ASTM 57C -20 to +50 °C.

The tester is equipped of a gas flame feeder.

**Power supply:** 230V 1ph 50-60Hz 700W

**Dimensions:** 200x300x400 mm approx.

**Weight:** 10 kg approx.



**B094-01 KIT**

## B094 KIT PENSKY-MARTENS DIGITAL FLASH POINT

STANDARDS: EN 22719 | ASTM D93 | AASHTO T73 | IP 34, 35  
ISO 2719

Used for the determination of the flash point of petroleum products by the Closed Cup Test, with a Flash Point between 40 °C to 360 °C.

Supplied complete with stirrer, shield for radiations, cast iron bath, electronic heater with digital thermoregulator two thermometers:

ASTM 9C -5 + 110 °C div. 0.5 °C,

and ASTM 10C +90 +370 °C div. 2 °C

**The stirrer allows to perform both "A" and "B" methods.**

The tester is equipped of a gas flame feeder.

**Power supply:** 230V 1ph 50Hz 700W

**Weight:** 10 kg approx.



**B093 KIT**

## B094-01KIT PENSKY-MARTENS FLASH POINT TESTER

Similar to mod. B094KIT, but with **electric** thermoregulator (not digital) and the stirrer performs **only** method "A"



**B094 KIT**

### SPARES

**B092-10** Thermometer ASTM 9C

**B092-11** Thermometer ASTM 57C

**B094-10** Thermometer ASTM 10C

## BITUMEN SUPERPAVE EQUIPMENT

Bitumen, as with all civil construction materials, is characterized by its mechanical properties. The first classification used in the past, and actually still working in many Countries nowadays, is based on **empirical properties**, such as penetration, softening point, breaking point and ductility. The importance of a performance analysis has been developed only in the last 20 years: by adopting empirical test procedures, bitumen mechanistic behaviour is not investigated, the test procedures are influenced by the operators and innovative binders cannot be properly tested.

Also, the traditional classification (such as penetration or viscosity grade) provides ambiguous results.

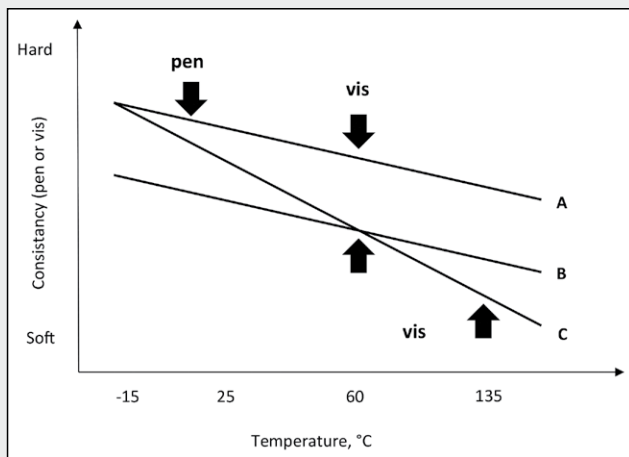

Example of empirical test comparison

In fact, two bituminous binders may have the same properties at different test temperature and much different behaviour at other ones.

The need to understand the mechanical properties and relation between the material and the damage that occurs during the service life of road pavement (low temperature cracking, fatigue cracks and rutting deformations) was the motivation behind the development of a new classification system known as **Superpave**: Superpave is an acronym for **Superior Performing Asphalt Pavements** and it is a new, comprehensive asphalt mix design and analysis system, developed by Strategic Highway Research Program (SHRP) to improve the performance and durability of roads. This method is different from the previous one and it is based on **PERFORMANCE**: focusing on bituminous binder, the modern classification introduced by Superpave is based on **Performance Grade (PG)**.

A unique feature of the Superpave system is that the tests are performed at temperatures and aging conditions that more realistically represent those encountered by in-service pavements. The Superpave PG binder specification requires the testing of the asphalt binder under project's expected climatic and aging conditions in order to help in reducing pavement distress. SHRP researchers developed new equipment standards as well as incorporated equipment used by other industries to develop the binder tests.

SUPERPAVE EQUIPMENT	PURPOSE
Dynamic Shear Rheometer (DSR)	Measure properties at high and intermediate temperatures
Rotational Viscosimeter (RV)	Measure properties at high temperatures
Bending Beam Rheometer (BBR) and Direct Tension Tester (DTT)	Measure properties at low temperatures
Rolling Thin Film Oven (RTFO)	Simulate hardening during asphalt production phase
Pressure Aging Vessel (PAV)	Simulate hardening during pavement life

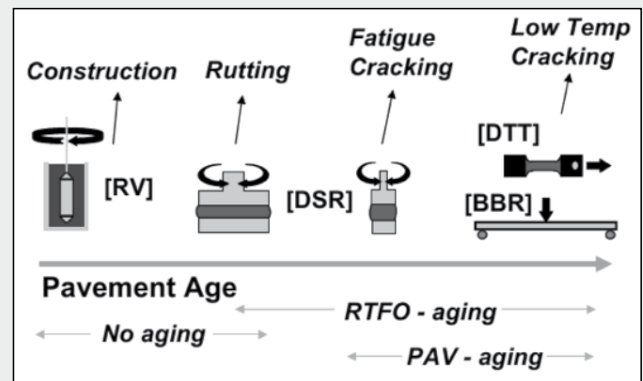

PG Testing Procedure

The new performance-based classification system introduces the **binder rheology based innovative testing conditions that real replicate the binder behaviour** from the construction phase including the concept of properties evolution due to ageing. Employing the new Superpave approach measures physical properties that can be related directly to field performance utilizing engineering principles. The key detail is that the Superpave tests characterize asphalt at a wide range of temperatures and aging. Superpave characterizes them at the actual pavement temperatures that they will experience, and at the periods of time when the asphalt distresses are most likely to occur.

## B085-07N DSR



### DYNAMIC SHEAR RHEOMETER

STANDARDS: EN 13702, 14770, 16659 | ASTM D7175, D4402, D4402M, D7405 | AASHTO T316, T350, M332, T315, M320

The Dynamic Shear Rheometer apparatus is used to characterize the **viscoelastic behavior of bituminous binders**, such as flow properties (shear viscosity from flow tests) and dynamic properties (viscoelastic modulus and phase angle from oscillation tests).

Different testing temperatures, especially with low temperatures, are possible with a rapid temperature control due to **peltier thermostating**,

Further measuring systems and cone-plate measuring systems according to the standard DIN are available.

Software for tests according to EN, ASTM and AASHTO allows:

- automatic and fast execution of all bitumen tests
- Automated evaluation and analysis of results according with AASHTO
- Estimation of **Performance Grade**
- Different test types for original binders, RTFO and PAV
- **Grade Determination** and **PASS/FAIL** conditions
- Bitumen Wizard for computer-assisted test execution
- Display and analysis of measuring data
- pre set profiles for automatic test execution

Complete with peltier temperate control, exchangeable basic plate (Ø 25 mm), exchangeable basic plate (Ø 8 mm), measuring plate (Ø 25 mm), measuring plate (Ø 8 mm), set of trimming tools rubber moulds (Ø 25 mm and 8 mm) soft ware and 20 ml calibration liquid.

The Rheometer requires to be connected to a PC, which is not included.

## B085-05 BBR

### BENDING BEAM RHEOMETER

STANDARDS: EN 14771 | ASTM D6648 | AASHTO T313

Bending Beam Rheometer is engineered to perform flexural tests on asphalt binder and similar specimens. These tests consist of a constant force being applied to a specimen in a chilled bath in order to derive specific rates of deformation at various temperatures.



**B085-05**

### TECHNICAL SPECIFICATION

- Torque range: 0.1 to 150 mNm
- Torque resolution: 0.002 mNm
- Bearing: mechanical bearing
- Speed resolution: 0.015 rpm
- Speed range: 0...1000
- Frequency range: 0.001...10Hz
- Temperature range, total: -60 °C to 375 °C
- Temperature range, Peltier: -10 °C to +180 °C
- Temperature accuracy: ± 0.02 °C

**Power supply:** 110V or 230V 1ph 50-60Hz

**Dimensions:** 800x400x700 mm

**Weight:** 45 kg approx.



**B085-07N**

### TECHNICAL FEATURES

- Integral stainless steel frictionless construction
- Load cell 500 g with mechanical overload protection
- Linear Variable Displacement Transducer (LVDT) 0.25 in (6.35 mm)
- Two independent platinum RTD for precise temperature control
- Liquid bath:
  - stainless steel construction
  - temperature range: -40 to 25 °C
  - Cools Ethylene Glycol - water - methanol mix (recommended for safety) to -40 °C.
- Compressed air: 0.34 MPa clean, dry air supply required
- Control, acquisition and analysis software
- Computer interface card
- Daily calibration routines
- Displays and graphs real time load, displacement and bath temperature

The BBR System includes: complete calibration kit with carrying case, 5 specimen molds with accessories, PC, accessories.

**Power supply:** 230V 1ph 50-60Hz **Weight:** 110 kg approx.

**B091M**
**PAV**
**PRESSURE AGEING VESSEL**

STANDARDS: EN 14769 | ASTM D6521 | AASHTO R28

PAV to simulates in-service oxidative aging that occurs in asphalt binders during service after 5 to 10 years (long-term aging). The sample is exposed to high pressure and temperature for 20 hours (selectable up to 99). The Pressure Ageing Vessel (PAV) features 100% compliance with the laboratory standards related to aging the bitumen. The unit consists of a stainless steel vertical pressure vessel (AISI 304 with ASME and CE certifications) enclosed in a cabinet with encased band heaters. A source of compressed air with a pressure of at least 2.1 MPa and a pressure regulator generates and maintains the aging condition required.

**MAIN FEATURES**

- Sturdy stainless steel frame and vessel.
- Fast pre-heating system selectable up to 60 °C in order to reduce the conditioning time.
- Timer for setting time and date to start the machine at the desired time.
- Innovative cooling system.
- Fully automatic, Semi-Automatic and Manual tests.
- Temperature and pressure monitored in real time.
- Integrated 7" colour Touch screen controller.
- Pressure monitored in real time by transducer and controlled to  $2.1 \pm 0.1$  MPa.
- CE and ASME certification.

The unit is equipped with a 7" colour Touch screen controller with front panel user interface with easy to use step-thru operation. The user-friendly software allows the operator to carry out the test in different modes:

- **AUTOMATIC:** It's possible to select from 4 different temperatures (85, 90, 100, 110 °C) and 2 different testing time (20 or 65 hours).
- **SEMI-AUTOMATIC:** It's possible to select a temperature from 60 to 120 °C and run the test for 20 or 65 hours as in the automatic mode;
- **MANUAL:** This mode can be used in research and it allows to manually select the temperature from ambient to 130 °C and the testing time from 1 to 99 hours.

**Temperature and pressure can be monitored in real time**, thanks to a platinum RTD probe and a pressure transducer. Data logs of both temperature, aging time and pressure are saved on USB stick at the end of the test.

A pre-heat mode allows to reach a maximum of 60 °C before introducing the sample in safety conditions reducing the conditioning time of the sample that can reach faster the test temperature. Thanks to an innovative heating system and the pre-heating mode the test can start in around 1 hour.

The instrument is supplied complete with a sample rack for the simultaneous testing of ten specimens, ten specimen pans as per standards, but without compressed air source, 2.1Mpa minimum pressure.

**B091M**
**TECHNICAL SPECIFICATION**

- Operating pressure:  $2.1 \pm 0.03$  Mpa (304 psi)
- Programmable temperature range: from ambient temperature to 130 °C, res:  $\pm 0.1$  °C
- Programmable pre-heating function: up to 60 °C
- Test temperature uniformity:  $\pm 0.5$  °C
- Testing time: up to 99 hours
- Safety equipment in all test conditions: Over pressure relief valve and Over temperature limit switch.

**Power supply:** 230V 1Ph 50Hz 10A

**Dimensions:** 450x650x500 mm approx.

**Weight:** 80 Kg approx.

**ACCESSORY**

- B091M-11** PRESSURE REGULATOR to connect the compressed air tank to the PAV, for an adequate inlet pressure.

**SPARES**

- B091M-10** Sample rack, for testing up to 10 samples at the same time
- B064-04** Stainless steel container, diameter 140x9.5 mm

**B091M-10**
**B091M1**
**PAV - RESEARCH VERSION**

Same to B091M but implemented with an electronic pressure valve to adjust the test pressure from ambient to 2.4 MPa, regulated from the control panel.

**B091M-01****VDO****VACUUM DEGASSING OVEN**

STANDARDS: EN 14769 | ASTM D6521 | AASHTO R28

The long-term aging of bitumen and bituminous binders obtained by a Pressure Ageing Vessel (PAV), generates air bubbles which must be removed in according with EN 14769, ASTM D6521 and AASHTO R28 standards. The Vacuum Degassing Oven, (VDO) consists of a stainless still vacuum vessel with a hinged lid to conserve space and access the vacuum chamber. It can hold up to 8 specimen containers. The unit allows selectable working temperature range from ambient to 200 °C with a resolution of  $\pm 0.1$  °C, measured by a platinum RTD probe. The VDO guarantees the required operating pressure of  $15 \pm 1$  kpa for the achievement of vacuum.

**MAIN FEATURES**

- Sturdy stainless steel frame.
- Temperature is measured by Platinum RTD.
- Pressure release valve.
- Over temperature limit switch.
- Fully automatic, Semi-Automatic and Manual test;
- Temperature and pressure monitored in real time.
- Automatic release of the pressure at the end of the test.
- Fast heating and vacuum system to reach set point.
- USB port on front unit with software upgrades and data storage.
- 7" colour touch screen controller with front panel user interface for temperature, vacuum, set points and actual values.

The unit is equipped with a 7" colour Touch screen controller indicating: temperature and pressure in real time and current stage of each process. The user-friendly software allows the operator to carry out the test in different modes:

- **AUTOMATIC:** Maintains the temperature constant at 170 °C for 30 minutes as required by the standards
- **SEMI-AUTOMATIC:** Selectable test temperature from ambient to 200 °C and the test runs for 30 minutes as in automatic mode
- **MANUAL:** Selectable both test temperature from ambient to 200 °C and time up to 99 minutes for research purposes

At the end of the test is possible to obtain uniform bitumen samples that can be used for further analysis to identify Performance Grade (such as DSR, DTT and BBR) or conventional bitumen properties (such as penetration, ductility, softening point among others)

**B091M-01****TECHNICAL SPECIFICATION**

- Operating pressure:  $15 \pm 1$  Kpa, res:  $\pm 0.1$  Kpa
- Test temperature:  $170 \pm 4$  °C, res:  $\pm 0.1$  °C
- Working temperature range: Ambient °C to 200 °C
- Power supply: 230V 1ph 50Hz
- Dimensions: 430x450x470 mm approx
- Weight: 30 kg approx.

**SPARE**

**B091M-20** Sample holder for 4  $\emptyset$  70x45 mm sample cup and for 8/10  $\emptyset$  55x35 mm sample cup

**NEEDED ACCESSORIES**

- V122-05** Sample cup, brass made,  $\emptyset$  55x35 mm
- V122-06** Sample cup, brass made,  $\emptyset$  70x45 mm

**B091M-20**Backside of **B091M-20**



## DYNAMIC VISCOSITY BY ROTATIONAL VISCOMETERS

STANDARDS: EN 13302 | ASTM D2196 | ASTM D4402 | AASHTO T316



A rotational viscometer is used to measure the dynamic viscosity of bitumen at elevated temperatures. The torque on the apparatus-measuring geometry, rotating in a thermostatically controlled sample holder containing a sample of asphalt, is used to measure the relative resistance to rotation. The torque and speed are used to determine the viscosity of the bitumen, expressed in pascal seconds (Pa.s), millipascal seconds (mPa.s), or centipoise (cP).

2 models available:

### B085-21N STANDARD ROTATIONAL VISCOMETER

Supplied with standard stand, spindles bayonet adaptor, temperature probe PT100, datalogger software, connecting cables, power supply cable.

### B085-22N ROTATIONAL VISCOMETER HIGH PERFORMANCE

Huge viscosity range. Supplied with rack stand, spindles bayonet adaptor, temperature probe PT100, datalogger software, connecting cables, power supply cable. It gives the possibility of programming and recording methods for the test. Optional direct control of temperature unit B085-33N



#### MAIN FEATURES

- High accuracy  $\pm 1\%$  on full scale
- High repeatability  $\pm 0.2\%$
- Direct measure with time to stop
- User and locked mode
- Data recording and USB transfer
- 7" touch screen display
- Torque gage on display
- Printer connection
- Compatible with Advanced Software

**Power supply:** 110-240V 50-60Hz

**Dimensions:** Head: 180x135xH250 mm

Stainless steel rod: Length 500 mm

Hardened steel stand: 400x250xH10 mm

**Weight:** 6.5 kg approx.

TECHNICAL SPECIFICATIONS	B085-21N	B085-22N
Unlimited rotation speed	0.3 and 250 rpm – free selection	between 0.3 and 1.500 rpm – free selection
Torque Range	0.05 to 13 mNm	0.05 to 30 mNm
Viscosity range	15 to 60 M mPa.s (M for millions)	2 to 140 M mPa.s (M for millions)
PT100 probe to indicate temperatures	between -50°C to 300°C	between -50°C to 300°C
Display showing	viscosity, speed, torque, shear stress, time, temperature, shear rate	viscosity, speed, torque, shear stress, time, temperature, shear rate
Choice of viscosity unit	cP/Poises or mPa.s/Pa.s	cP/Poises or mPa.s/Pa.s
Languages	English, Italian, Spanish, German, French, Russian, Turkish	English, Italian, Spanish, German, French, Russian, Turkish
Connections	PC and Printer	PC and Printer

## NEEDED ACCESSORIES

In order to perform test according to EN 13302 and ASTM D4402:

### B085-29

BATH WITH TEMPERATURE CONTROLLER UP TO 200 °C  
Temperature range from 5 °C to 200 °C  
Complete with 12 liters tank and lid.  
Power supply: 230V 50Hz 2060W  
Dimensions: 500x400x500 mm  
Weight: 12 kg approx.

or

### B085-33N

TEMPERATURE CONTROL DEVICE UP TO 300°C  
Electric heating device to reach a sample conditioning temperature of 300°C, performing the test according to the ASTM and EN standard requirements. It can be controlled by the advanced software (B085-26N) when used in combination with B085-22N.  
The integrated control unit allows to set the test temperature and perform the test with an accuracy of  $\pm 0.2^\circ\text{C}$ .  
Power supply: 110-240V 50-60Hz  
Dimensions: 610x340xH650 mm  
Weight: 16 kg approx.



B085-29



B085-33N

**B085-35** CONTAINER for small sample volumes for spindle TR8 (int.  $\varnothing$  25 mm)

**B085-36** CONTAINER for small sample volumes for spindle TR9, TR10, TR11 (int.  $\varnothing$  19 mm)

**B085-34N** SPINDLE COMPLETE SET (TR8, TR9, TR10 and TR11) composed of:

**B085-34N1** SPINDLE TR8

**B085-34N2** SPINDLE TR9

**B085-34N3** SPINDLE TR10

**B085-34N4** SPINDLE TR11

CODE	SHEAR RATE	VISCOSITY RANGE IN mPa.s	
		B085-21N	B085-22N
B085-34N1	0.92N	14 to 3M	2 to 7M
B085-34N2	0.34N	75 to 16M	12 to 37M
B085-34N3	0.28N	146 to 31M	24 to 72M
B085-34N4	0.25N	300 to 64M	50 to 149M



B085-34N

## ACCESSORIES

### B085-26N

ADVANCED SOFTWARE

The advanced software permits the remote control of the viscometer through PC. In addition, it has important features for the user:

- It allows creation and saving of methods, transfer and processing of data from memory of instruments.
- Use of mathematical tools for data analysis.
- Creation of free program and report editing.
- New graphical tools allow custom management of the display of curves, tables and analysis results
- Combined with B085-22N, it allows control and temperature ramp creation.

**B085-37** CONTAINERS' SUPPORT

**B085-38** CIRCULAR LEVEL

**B085-39N** SPINDLE SET FROM R2 TO R7

**B085-40N** EXTERNAL TEMPERATURE PROBE

**V174** CRUCIBLE TONGS



B085-39N



V174

B085-37

B085-38

B085-35

B085-36

## DYNAMIC VISCOSITY DETERMINATION

### B088N VISCOMETER BATH

STANDARDS: EN 12595 | ASTM D2170

This viscometer bath is used to determine both the Dynamic and Kinematic viscosity of liquid asphalts, keeping the capillary type viscometers at a uniform temperature.

Consisting of:

- Borosilicate glass container 15 liters capacity
- Additional tempered glass container
- Stainless steel base with insulating cork sheet
- Stainless steel control box with selector and digital temperature reading

- Stainless steel lid with five holes for capillaries

Temperature range: room to 150 °C

Allows to simultaneous temperate five capillaries.

Viscometers and thermometers **are not included**.

**Power supply:** 230V 1ph 50-60Hz 1200W

**Dimensions:** 350x350x520 mm

**Weight:** 15 kg approx.

#### MAIN FEATURES

- Extremely precision ( $\pm 0.02$  °C stability).
- 4.3" LCD display.
- PID controller.
- PT 100A probe included.
- Overheating alarm system and security water level.
- Motor stirrer, heating element, cooling coil.



**B088N**

#### ACCESSORIES

**B088-03N** SILICONE OIL, type 50 cSt, for tests with B088N bath with temperature range: 100 °C up to 150 °C.

Can of 20 kg

**B088-05N** HOLDER, stainless steel made, for Cannon-Manning and Asphalt Institute viscometers

**B088-06N** HOLDER, stainless steel made, for Cannon-Fenske viscometers

**B088-07N** HOLDER, stainless steel made, for Zeitfuchs cross-arm viscometers

**B088-08N** HOLDER, stainless steel made, for Cannon BS reverse flow viscometers

**B088-12** KINEMATIC VISCOSITY THERMOMETER, range 58.5 to 61.5 °C, type ASTM 47C

**B088-13** KINEMATIC VISCOSITY THERMOMETER, range 133.5 to 136.5 °C, type ASTM 110C

### B088-01N VACUUM VISCOMETER BATH

STANDARDS: EN 12596 | ASTM D2171 | AASHTO T202 | IP 222

This Vacuum Viscometer Bath is specially designed for tests that require ultra – precise temperature and vacuum control, or processes that need to be followed visually. All wetted parts are made of stainless steel, providing resistance against all usual bath fluids. The bath can be operated from ambient +5 (with a cooling system) up to +230 °C (41...446 °F). The set point can be set in steps of 0.01 °C. The system overall accuracy is within  $\pm 0.01$  °C. After the temperature control is stable, the offset can even be adjusted with  $\pm 0.005$  °C. The Bath is already equipped with the digital vacuum controller, the vacuum manifold to offer 4 positions and all tubing to perform the test. This system further offers high precision and feedback regulation on the vacuum, within 0,5 mm Hg (or mBar) of its set point.

**Power supply:** 230V, 50-60Hz

**Dimensions:** 720 x 400 x 590 mm

**Weight:** 50 Kg approx.

#### TECHNICAL SPECIFICATIONS

- Temperature Range: Ambient to 230°C;
- Temperature Stability:  $\pm 0.01$ °C;
- Bath Volume: 40 litres;
- Pressure Range: 30 to 430 mBar (negative pressure);
- Pressure Accuracy:  $\pm 0.5$  mBar;
- Digital Vacuum Controller;
- 4 viscometer positions;
- Selectable readout via setup: mm Hg, mBar, PSI



**B088-01N**

#### SPARES

**B088-16N** Vacuum pressure regulator, for precise control during test. 230 V, 50-60 Hz

**B088-17N** Vacuum manifold, to obtain vacuum to the viscometers introduced into the bath

## KINEMATIC VISCOSITY DETERMINATION

STANDARDS: EN 12595 | ASTM D2170 | AASHTO T201

### CANNON-MANNING VACUUM VISCOMETERS

To determine the viscosity of bitumen at 60 °C.  
Supplied complete with calibration certificate.

Model	Viscosity range		Model	Viscosity range	
<b>B088-20</b>	0.036	to 0.8	<b>B088-26</b>	36	to 800
<b>B088-21</b>	0.12	to 2.4	<b>B088-27</b>	120	to 2400
<b>B088-22</b>	0.36	to 8	<b>B088-28</b>	360	to 8000
<b>B088-23</b>	1.2	to 24	<b>B088-29</b>	1200	to 24000
<b>B088-24</b>	3.6	to 80	<b>B088-30</b>	3600	to 80000
<b>B088-25</b>	12	to 240			

**Note:** to measure the viscosity with the Cannon-Manning viscometers, the B088-01N bath, the B088-05N holder and asphalt institute vacuum viscometers are also needed.



### ASPHALT INSTITUTE VACUUM VISCOMETERS

To determine the viscosity of bitumen at 60 °C.  
Supplied complete with calibration certificate.

Model	Viscosity range	
<b>B088-34</b>	42	to 800
<b>B088-35</b>	180	to 3200
<b>B088-36</b>	600	to 12800
<b>B088-37</b>	2400	to 52000
<b>B088-38</b>	9600	to 140000
<b>B088-39</b>	38000	to 580000



### CANNON-FENSKE OPAQUE VISCOMETERS, REVERSE-FLOW TYPE

To determine the kinematic viscosity of bitumen, distillation residues of opaque liquid asphalts, asphalt cements at 135 °C, and road oils at 60 °C. Supplied complete with calibration certificate.

Model	Approx. constant mm <sup>2</sup> /s <sup>2</sup>	Viscosity range mm <sup>2</sup> /s <sup>2</sup>	
<b>B088-50</b>	0.002	0.4	to 2
<b>B088-51</b>	0.004	0.8	to 4
<b>B088-52</b>	0.008	1.6	to 8
<b>B088-53</b>	0.015	3	to 15
<b>B088-54</b>	0.035	7	to 35
<b>B088-55</b>	0.1	20	to 100
<b>B088-56</b>	0.25	50	to 200
<b>B088-57</b>	0.5	100	to 500
<b>B088-58</b>	1.2	240	to 1200
<b>B088-59</b>	2.5	500	to 2500
<b>B088-60</b>	8	1600	to 8000
<b>B088-61</b>	20	4000	to 20000
<b>B088-62</b>	45	10000	to 40000
<b>B088-63</b>	100	20000	to 80000



**Note:** to measure the kinematic viscosity with the Cannon-Fenske viscometers, the B088N or the B088-01N baths and the B088-06N holder are also needed.

**Note:** to measure the kinematic viscosity with the BS viscometers, the B088N or the B088-01N baths and the B088-08N holder are also needed.



### ZEITFUCHS CROSS-ARM VISCOMETERS

To determine the kinematic viscosity of bitumen, distillation residues of liquid asphalts, asphalt cements at 135 °C, road oils.  
Supplied complete with calibration certificate.

Model	Approx. constant mm <sup>2</sup> /s <sup>2</sup>	Viscosity range mm <sup>2</sup> /s	
<b>B088-70</b>	0.003	0.6	to 3
<b>B088-71</b>	0.01	2	to 10
<b>B088-72</b>	0.03	6	to 30
<b>B088-73</b>	0.1	20	to 100
<b>B088-74</b>	0.3	60	to 300
<b>B088-75</b>	1	200	to 1000
<b>B088-76</b>	3	600	to 3000
<b>B088-77</b>	10	2000	to 10000
<b>B088-78</b>	30	6000	to 30000
<b>B088-79</b>	100	20000	to 100000



**Note:** to measure the kinematic viscosity with the Zeitfuchs cross-arm viscometers, B088N or B088-01N and corresponding holders are also needed.

### CANNON BS-IP-RF FLOW REVERSE VISCOMETERS

To determine the kinematic viscosity of bitumen, distillation residues of liquid asphalts, asphalt cements at 135 °C, road oils.  
Supplied complete with calibration certificate.

Model	Approx. constant mm <sup>2</sup> /s <sup>2</sup>	Viscosity range mm <sup>2</sup> /s	
<b>B088-80</b>	0.003	0.6	to 3
<b>B088-81</b>	0.01	2	to 10
<b>B088-82</b>	0.03	6	to 30
<b>B088-83</b>	0.1	20	to 100
<b>B088-84</b>	0.3	60	to 300
<b>B088-85</b>	1	200	to 1000
<b>B088-86</b>	3	600	to 3000
<b>B088-87</b>	10	2000	to 10000
<b>B088-88</b>	30	6000	to 30000
<b>B088-89</b>	100	20000	to 100000
<b>B088-90</b>	300	60000	to 300000

**B024-10**  
**RADIAL-FLOW FALLING HEAD PERMEAMETER**

STANDARD: EN 12697-40

Used to determine the time taken for 4 liters of water to dissipate through an annular area of the surfacing of a pavement under known conditions.

Consisting of:

- acrylic tube 125 mm inside diameter, 560 mm long, marked at 1 liter and at 5 liters
- internal rod with rubber ball valve
- wooden base with sealing gasket

**Dimensions:** 800x450x680 mm

**Weight:** 8 kg approx.

**B024-10**
**B024-05**  
**CONICAL SIEVE 0.355 mm MESH**

STANDARD: EN 15366:2010

Used to verify the absorption degree of mineral oils and hydrocarbons from granulate products spread on the road during winter time.

**B024-05**
**B024**  
**PERMEAMETER**

FOR DRAINING PAVEMENTS IN SITU

 STANDARD: ITALIAN HIGHWAY SYSTEM,  
 COMPARABLE TO MPW OF BELGIUM

Mainly used in situ to perform and to check the permeability and drainage on road carpets, concrete pavements, tamped earth etc. The test consists in filling the cylinder with water, after ermetically positioning it on the carpet under test and then in calculating the time needed by a certain quantity of water to be absorbed by the same. The instrument is composed of a bottomless plexiglass cylinder 140 mm inside diameter, fitted on a base. The cylinder has two black calibration lines: one at zero point and one at 250 mm.

**Dimensions:**

260x260x425 mm

**Weight:** 8 kg approx.

**B024-01**
**B024**
**ACCESSORY**
**B024-01**

WEIGHT KG 5, annular shape, to apply on the base of the permeameter, to improve its adherence to the material under test.

**B099-10**  
**SAND PATCH EQUIPMENT**

STANDARDS: EN 13036-1 | ASTM E965 | NF P98 216-1

Road and airfield surface characteristics.

Measurement of pavement surface to determine the average macrotexture depth using a volumetric patch technique.

The equipment comprises:

Spreader disc with handle and rubber coated surface. Wind shield

Soft brush. Screw-adjusted compass 500 mm graduated rule.

Metallic cylinder for spheres volume measurement.

Two glass pycnometers with metallic screw top and pouring hole

Three graduated cylinders 10.25 and 50 ml cap. Knee-guard

Carrying case

**Weight:** 4 kg approx.

**B099-10**
**ACCESSORIES**
**B099-15** GLASS SPHERES, size 180/212 microns to EN 13036-1  
 Pack of 5 kg.

**B099-16** NATURAL SAND 300/150 microns, 25 kg bag.  
 ASTM E965.

**B099-17** NATURAL SAND 150/75 microns, 25 kg bag.  
 ASTM E965

**SAMPLING OF ASPHALT ROAD CORES**  
 DETERMINATION OF PHISICAL PROPERTIES AND  
 COMPOSITION

STANDARD: EN 12697-27

**C319**  
**PAVEMENT CORE  
 DRILLING MACHINE**

Technical details, other models of machines, coring bits etc. described in section "C" p. 356



**C319**

## B098N TRAVELLING BEAM DEVICE

Used to detect and check any irregularity in both bituminous and concrete road surfaces. The unit consists essentially of a 3 metre long beam fixed on two rigid wheels at the extremities. In the middle of the beam a sensing unit comprising a wheel connected to an indicator provides a magnification of 4:1 and measures deviations of the surface. The deviations are shown on a scale calibrated in increments of 2 mm up to 10 mm and 5 mm up to 25 mm. The beam is supplied as three sub-assemblies which are quickly assembled on site.

**Dimension:** 790x3200x1080 mm approx.

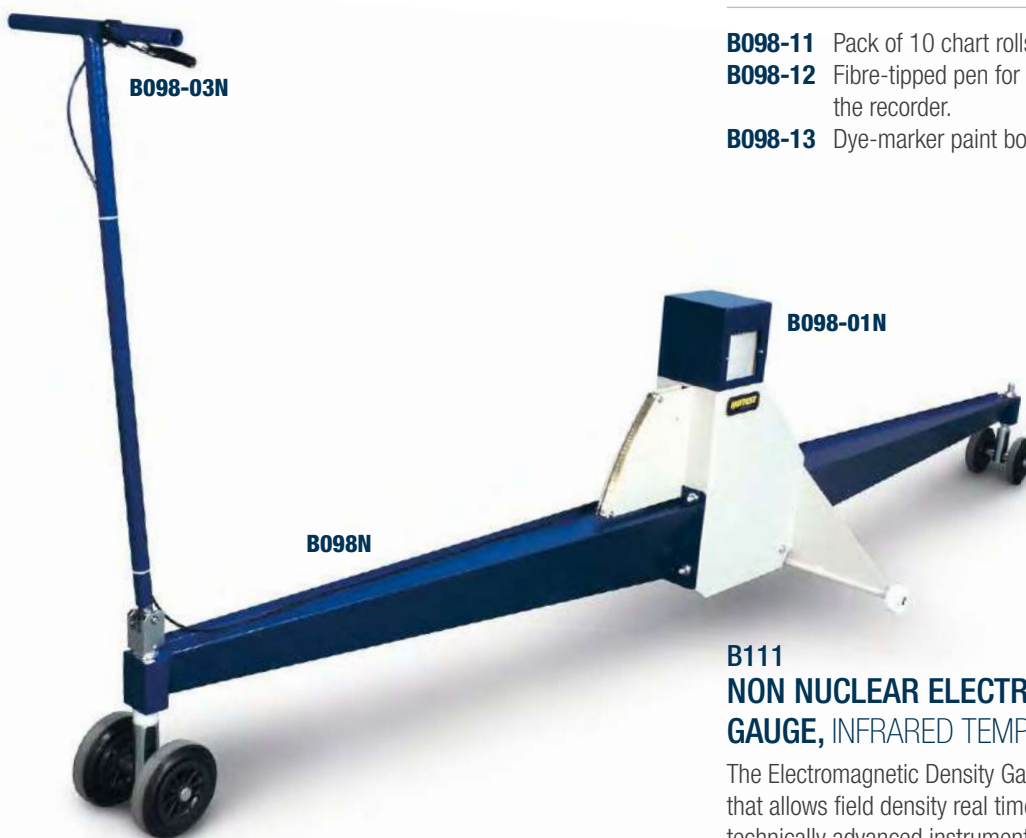
**Weight:** 55 kg approx.



### ACCESSORIES

#### B098-01N AUTOGRAPHIC RECORDING DEVICE

When connected to the Travelling Beam Device mod. B098N, it provides a permanent record of the surface profile. It records up to 1000 metre surface on the special chart paper rolls. Supplied complete with 10 chart rolls and 2 fibre-tipped pens.

**B098-03N** DYE-MARKER with paint bottle, used to identify suspect areas.

**B098-05** WOODEN CARRYING CASE to house the Travelling Beam Device. **Dimensions:** 1480x680x510 mm approx.

### SPARES

**B098-11** Pack of 10 chart rolls for approx. 1000 metre run.

**B098-12** Fibre-tipped pen for use with the recorder.

**B098-13** Dye-marker paint bottle.

#### B111 NON NUCLEAR ELECTROMAGNETIC DENSITY GAUGE, INFRARED TEMPERATURE SENSOR

The Electromagnetic Density Gauge is a non nuclear sensing device that allows field density real time measurement of asphalt. This technically advanced instrument for quality control allows operators to immediately identify spots with low pavement density and trigger corrective actions leading to more uniform pavements.

The Electromagnetic densimeter allows:

- Pavement tests.
- Real time measurements, in a continuous mode.
- LCD visualization of:
  - Average density.
  - % Maximum density.
  - % Air voids.
- Non Nuclear device, so maximum safety for operator
- Storing up to 999 measurement data records and RS-232 computer interface.
- Infrared sensor for an accurate measurement of the road surface (optional).
- Rechargeable batteries for 32h continuous usage.
- Charging supply for standard 230V 50Hz or 12Vcc.

**Dimensions:** 229x406x152 mm

**Weight:** 5 kg approx.



**B099 KIT**  
**MOT STRAIGHT EDGE WITH 2 WEDGES**

 IRREGULARITY MEASUREMENT OF PAVEMENT SURFACE  
 STANDARD: EN 13036-7

Consisting of:

**B099N**  
**MOT STRAIGHT EDGE**

Manufactured from anodized aluminium alloy, it is utilized to measure irregularities of road pavement, floors, concrete pavement. Length is 3000 mm, width 26 mm, adjustable in height from 0 to 30 mm.

Supplied without graduated wedges.

**Dimensions:** 150x3050x130 mm approx.

**Weight:** 9 kg approx.

**B099-01N**

GRADUATED WEDGES, anodized aluminium alloy (set of two)

**B100**  
**BENKELMAN BEAM APPARATUS**

STANDARDS: ASTM D4965-03 | CNR N° 141

Alluminium alloy made, complete with dial indicator and accessories, it is utilized to measure the deflection of the road surface when loaded by the wheels of vehicles. The beam is put in contact with the pavement under test between the tires of the vehicle. The measurement of the deflection is performed when the vehicle passes over the test area.

Length of the Benkelman beam is 2500 mm.

Beam fulcrum ratio 4:1

Supplied complete with wooden carrying case.

**Dimensions:** 430x1800x350 mm approx.

**Weight:** 16 kg approx.

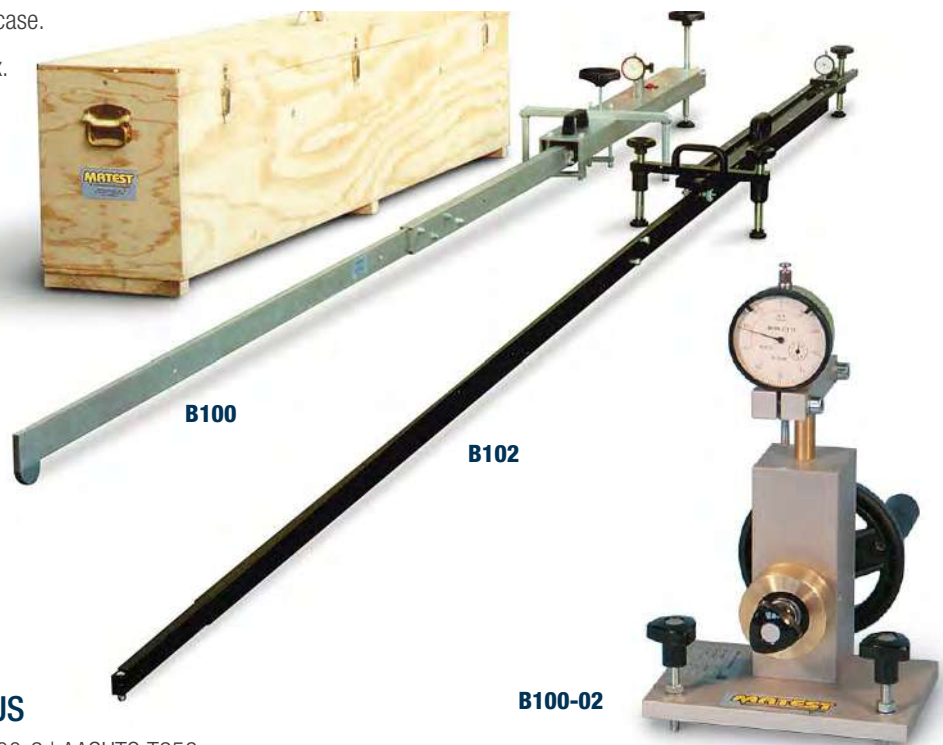
**B099 KIT**
**B099-01N**

**B100**
**B102**
**B100-02**
**B102**  
**BENKELMAN BEAM APPARATUS**

STANDARD: ASTM D4965-03 | NF P98-200-2 | AASHTO T256

Basically similar to mod. B100 but manufactured according to the French Specifications. Beam fulcrum ratio 2:1

Complete with wooden carrying case.

**Dimensions:** 430x1800x350 mm approx.

**Weight:** 16 kg approx.

**ACCESSORY**
**B100-02**

BENKELMAN INDICATOR GAUGE CALIBRATION UNIT, complete for mod. B100 and B102. To verify the accuracy of the apparatus.

## B103-10 BEARING PLATE 600 MM DIAMETER CAST ALUMINIUM WITH REINFORCING RIBS

STANDARD: NF P94-117-1

The plate is equipped with a central device to measure the static deformation of road pavements (EV2) with the Benkelman Beam, and the bearing capacity of a soil in-situ.

The plate foresees also three screwed lateral holes for three point measurements of the bearing capacity of a soil in-situ.

Supplied complete with coupling device to the hydraulic jack.

**Weight:** 25 kg approx.



**B103-10**

USE EXAMPLES OF THE ALUMINIUM BEARING PLATE:

### B103-05 KIT PLATE BEARING EQUIPMENT, 200KN CAPACITY

STANDARD: NF P94-117-1

To determine the static deformation of flexible road pavement (EV2) in the centre of the loading plate.

Used with the Benkelman Beam apparatus mod. B102

The equipment consists of:

**B103-10** Bearing plate 600 mm dia. cast aluminium with reinforcing ribs and coupling device.

**S225-01** Hydraulic loading jack 200 kN capacity, complete with **double speed hand pump ensuring fast approach**, rubber pipe with fast connector, set of extension rods of different lengths, carrying case.

**S225-02** Precision pressure gauge 0 - 200 kN, div. 1 kN

**S226-13** Upper spherical seat.

Total weight: 70 kg approx.

 **Note:** each item can be ordered separately



**B103-05 KIT**

**B102**

### ACCESSORY

**B102** BENKELMAN BEAM APPARATUS according to Standards: ASTM D4965-03 | NF P98-200-2 AASHTO T256

Use examples of the aluminium bearing plate Ø 600 mm for bearing tests of a soil in-situ with the 200 kN plate bearing equipment mod S225 KIT (see p. 516 of the catalogue).



**B102**

**S225 KIT + B103-10**



## A113 SKID RESISTANCE AND FRICTION TESTER

MEASUREMENT OF SKID RESISTANCE OF AN ASPHALT SURFACE

STANDARDS: EN 13036-4 | EN 1097-8 | BS 7976 | ASTM E303

The apparatus is suitable for both site and laboratory applications to perform two types of tests:

- For measuring pavement (road asphalt) surface frictional and skid resistance properties.
- For polished stone value tests on aggregates (curved specimens) from accelerated polishing tests.

For further technical details, see p. 56

The tester is supplied **without** rubber sliders and accessories that have to be ordered separately.

**Case dimensions:** 730x730x330 mm

**Weight:** 32 kg approx



**A113**

### ACCESSORIES

- A110-03** MOUNTED RUBBER SLIDER, TRL rubber, 76 mm width for site use (road surface), complete with conformity certificate.
- A110-01** MOUNTED RUBBER SLIDER, TRL rubber, 32 mm width for Polished Stone Value tests (laboratory), complete with conformity certificate.
- A110-05** MOUNTED RUBBER SLIDER, 4S rubber, 76 mm width (ceramics, marbles, paving tiles, sidewalk surface) complete with conformity certificate. Standards: EN 13036-4 / BS 7976
- A110-11** METAL BASE PLATE for Polished Stone Value tests in laboratory, and for tests on natural stones and concrete block pavers. Supplied **without** specimen clamping devices (to be ordered separately).
- A110-12** CLAMPING DEVICE for Polished Stone Value tests in Laboratory.
- A110-13** CLAMPING DEVICE for tests on natural stones (EN 1341, 1342); for concrete block pavers (EN 1338) and skidding tests on wooden floor (EN 1339).
- A110-20** PINK LAPPING FILM (10 sheets) for Skid Calibration.



**A113**  
in carrying case

**A110-11 + A110-12**

**A110-03**

**A110-01**

## A128N ACCELERATED POLISHING MACHINE

DETERMINATION OF THE POLISHED STONE VALUE

STANDARDS: EN 1097-8, EN 1341, 1342, 1343 | BS 812:114  
NF P18-575 | CNR N.105

It measures the resistance of road aggregates, paving stones and paving blocks to the polishing action of vehicle tyres on a road surface. The specimens are manufactured with suitable moulds and located on the Road Wheel.

Supplied complete with 2 rubber wheels (one for corn and one for flour emery), set of 4 specimen moulds and 2 mould covers, while control stone, corn and flour emery have to be ordered separately (see accessories).

Technical details and accessories: see p. 58

**Power supply:** 230V 50Hz 1ph 750W

**Dimensions:** 1800x820x600 mm

**Weight:** 175 kg approx.



**A128N**

# SECTION B

## ASPHALT | BITUMEN | PAVETEST

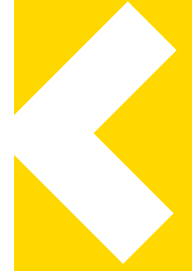

Bituminous mixture, also known as asphalt mixture, is mainly composed by aggregates and bitumen, an infinite variety of mixtures being possible. This section is divided into three parts and shows the whole range of equipment for analyzing each component of the bituminous mixture.

**ASPHALT.** The first part is dedicated to the asphalt testing machines used to provide a solution for the whole “asphaltic path”: mixing, compacting, modelling and testing. The equipment meets the needs of those who want to perform quality control or experimentation of new asphalt mixtures.

**BITUMEN.** This section shows equipment required for bitumen testing: these include machines to study the rheological properties of bitumen as well as the features of bituminous emulsion. The last part of this section provides better solutions to perform field tests on road surface.

**PAVETEST.** Pavetest’s range of pavement dynamic testing systems both complements and completes Matest’s Asphalt and Bitumen business unit. All our products comply with the principal international standards.



## CDAS

## CONTROL AND DATA ACQUISITION SYSTEM

Pavetest's compact Control and Data Acquisition System (CDAS) delivers unparalleled performance, real time control and ultimate versatility in acquisition and provide a flexible and user friendly testing solution.

It provides excellent waveform fidelity from integrated acquisition and control functions, with low level sampling at speeds of up to 192,000 samples per second simultaneously on all channels and 20 bit resolution over the full dynamic input signal range.

## MAIN FEATURES

- Directly communicates with the TestLab software, providing automatic test execution and data processing.
- Compact high reliability data acquisition and control.
- Up to 5 kHz data acquisition and feedback control provides excellent waveform fidelity.
- Up to 64 times oversampling gives superior low noise performance.
- Normalized ( $\pm 10$  V) analog data acquisition inputs provide flexibility to use any transducer in any channel.



**B206** CDAS 16 channels

## EASY DATA PROCESSING WITH THE INCLUDED SOFTWARE

The CDAS includes the TestLab software - supplied on USB flash drive - complete with relevant Method files (based on the test configurations supplied) and calibration files for all the transducers supplied. Software and test methods are expandable for future requirements.

## AVAILABLE MODELS

**B205**

**8 Channel CDAS** - Acquisition 8 CH, 20 bit resolution

- Sampling rate up to 192 kHz (all channels)
- Smoothing up to 64 times over-sampling
- Calibration on power up
- Control Axis 2
- Communication USB or Ethernet

**B206**

**16 Channel CDAS** - Acquisition 16 CH, 20 bit resolution

- Sampling rate up to 192 kHz (all channels)
- Smoothing up to 64 times over-sampling
- Calibration Automatically on power up
- Control Axis 4
- Communication USB or Ethernet

**Dimensions:** 110(h) x 325(d) x 265(w) mm

**Power Supply:** 90-264V 50-60Hz 1ph 240W

**Weight:** 5 kg approx.

## TECHNICAL FEATURES

**CONTROL:**

- High speed, (18 bit) digital servo-control, up to 4 axis.
- Digital closed loop update sampling rate of 2.5 kHz.
- Computer programmable, Proportional, Integral and Derivative (PID) control algorithm.
- Adaptive Level Control (ALC) algorithm for best dynamic peak accuracy.
- 3 feedback control modes. E.g. force, position and on-specimen strain.
- "Bumpless transfer" between control modes.

**ACQUISITION:**

- Analog inputs are automatically calibrated on power up.
- Simultaneous sampling of all channels.
- 16 Analog ( $\pm 10$  Volt) input channels.
- Up to 64 times over sampling (set to 8 by default).
- 20 bit digital resolution (**approx. 1/1.000.000**), no auto ranging required.
- Sampling rate up to 192.000 samples/see.

## TESTLAB SOFTWARE

Developed with ultimate flexibility in mind, TestLab test and control software caters to all levels of operator experience. By using pre-programmed **Method files**, an inexperienced operator can run a range of international test methods without the need for any programming. Moreover, a test **Wizard**, available with popular tests, can guide the operator step by step based on a recipe book approach. Most importantly, the experienced engineer and/or researcher need not be constrained by the functions and analysis in the method files provided. The operator may clone, modify and/or generate his/her own method file to suit their specific requirements. The Excel based data analysis offers the operator the flexibility to implement alternative analysis and customize reporting facilities. TestLab allows for real time graphing of results and configurable real time transducer levels display with unprecedented clarity of results and analytical power.

### MAIN FEATURES

- Open architecture software allows user to inspect calculations and results.
- Integrated data result post processing feature with MS Excel.
- Standard and user customizable test reporting.
- Real time graphing of results and configurable real time transducer.
- Flexible and user-friendly with unprecedented clarity of results and analytical power.
- Full access for advanced user to specify their own calculations, test results and charting.



## TESTLAB, A NEW APPROACH

TestLab is an open architecture user programmable software application. Our engineers have taken the time to review all the relevant international test standards and used TestLab **Test Designer** to program method files according to these standards. Basically, any of these tests can be designed, cloned and/or modified by the user within TestLab. The user is no longer restricted to the test applications provided at time of purchase the possibilities are only limited by the skill and imagination of the user.

### TESTLAB MANAGER

The Testlab materials testing software is a universal approach to materials testing and is designed to interface the CDAS – Control and Data Acquisition Systems - and the wide range of Pavetest machines. A Testlab Manager interface allows users to easily and efficiently locate the necessary method files to load and execute.



Testlab Manager

### TEST METHOD SELECTION

The operator can run pre-programmed Method files, in accordance to the requested Standards, or configure an application test and then save that configuration to a customised Method file. This includes the transducer and calibration allocations, control parameters, termination conditions and any other items, which allow users to enter data. Method files may easily be “cloned”, adapted and saved to be used at a later stage with pre-set preferences.

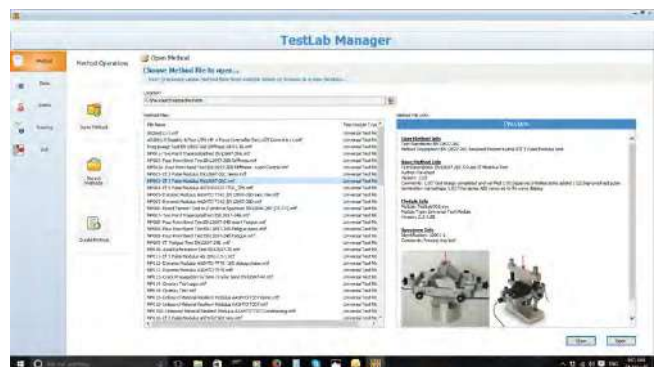

Selection of Method Files

## UPGRADE YOUR UNIVERSAL TESTING MACHINE

It is a well-known fact that the controller and software is one of the most important aspect of any system and the main reason testing machines become outdated or obsolete. The original machine manufacturer often charge outrageous prices to upgrade the Control and Data Acquisition System and Software, knowing the customer has very little choice.

**Pavetest has now made it easier than ever to upgrade third party servo-hydraulic/pneumatic dynamic testing machines**, including but not limited to IPC Global, Cooper, Interlaken, MTS and Instron machines, to Pavetest's leading-edge Control and Data Acquisition System (CDAS) and world acclaimed TestLab software.

### MAIN FEATURES

- TestLab Software provides powerful and flexible solution.
- Comprehensive suite of pre-programmed Method Files.
- Ability to create your own Method Files.
- Adaptable for existing transducers.
- In-line signal conditioners.
- Interfaces to most third party Hydraulic Power Supplies.

### TESTLAB PC SOFTWARE

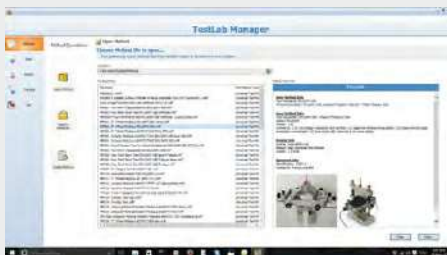

Selection of Method Files

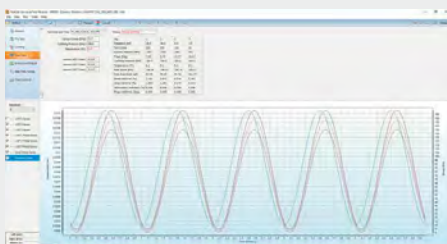

Test Methods



Typical dashboard screen



CDAS and HPS interface

### THIRD PARTY TESTING MACHINES

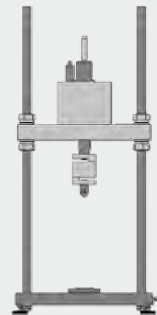

Servo Pneumatic test machine

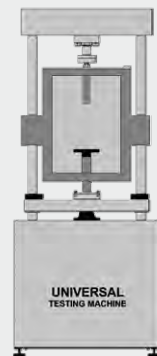

Servo Hydraulic test machine

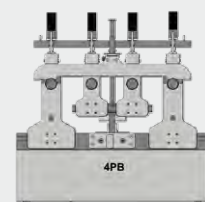

4 PT Beam test machine

## UPGRADE BENEFITS

This immediately offers the user access to a comprehensive suite of pre-programmed Method Files and/or the opportunity to create their own Method Files, to suit their individual needs. Pavetest can also provide interface cables and signal conditioners to adapt existing transducers to the Pavetest CDAS and offer additional transducers, already fitted with in-line signal conditioners to suit existing and new testing applications.

For servo-hydraulic systems; the Pavetest microprocessor controlled HPS interface unit allows Pavetest to interface our CDAS to most third party Hydraulic Power Supplies.

**Our 40 plus years' experience with servo-controlled systems and instrumentation places us in a strong position to restore your outdated system to current day standards.**



### MODULAR CONCEPT

Both the CDAS hardware and TestLab software use a modular approach allowing users to add new functionality to perform additional materials tests.



### AVAILABLE FOR ALL LANGUAGES

TestLab has a complete inbuilt language translation editor catering for translation of all languages.



### RENEWED PERFORMANCE

TestLab provides new and advanced acquisition and control capabilities for your old testing machine.



### COMPLETE INSTALLATION AND TRAINING

Pavetest can provide a complete onsite installation, commissioning and training for your upgrade package including supply of additional jigs, method files and transducers.

## ORDERING INFO

- B205** 8 channel CDAS  
or  
**B206** 16 channel CDAS  
**B205-01** HPS interface box  
**B205-02** 6 pin DIN (male) to 7 pin XLR (female) adaptors cable  
**B205-03** 6 pin DIN (female) to 7 pin XLR (male) adaptors cable



8 Channel Pavetest CDAS with Frame Control Interface.

## EXAMPLE OF SYSTEMS UPGRADED BY PAVETEST



Interlaken UTMs equipment upgraded by Pavetest, AAT, USA.



IPC Global UTM5P and UTM14P equipment upgraded by Pavetest, Fulton Hogan, Australia.

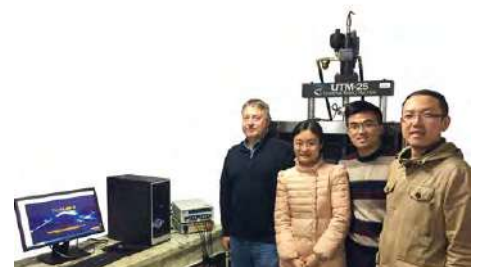

IPC Global UTM-25 equipment upgraded by Pavetest, SEU, China.

## 16 KN SERVO-PNEUMATIC DYNAMIC TESTING SYSTEM

TWO MODELS AVAILABLE:

### B220-01 KIT

#### DTS-16 WITH MANUAL CROSSHEAD

### B220-02 KIT

#### DTS-16 WITH MOTORIZED CROSSHEAD

The DTS-16 Dynamic Testing System is a servo-pneumatically controlled testing machine utilizing digital control of a pneumatic servo valve to provide accurate loading wave shapes up to 70 Hz. The DTS-16 can be operated in tension, compression dynamic loading and is suited to testing a diverse range of materials such as asphalt, soil, unbound granular materials, fibres and plastics.

The DTS-16 is underpinned by Pavetest's leading edge CDAS digital controller, TestLab software and a full complement of accessories, hardware and software in perfect unison.

### MAIN FEATURES

- Compact, robust 2-Column load frame.
- Precision engineered.
- Optional Motorized crosshead positioning.
- Fully configurable to suit a large range of testing applications.
- Digital Servo-Pneumatic control.
- 4 axis control and 16 Channel Control and Data Acquisition System.

The machines includes:

**B220-11** 20 kN Load frame with manual crosshead,  
16 kN Servo-pneumatic actuator with its  
LVDT (30 mm stroke),  $\pm 20$  kN load cell

or

**B220-12** 20 kN Load frame with motorized crosshead,  
16 kN Servo-pneumatic actuator with its  
LVDT (30 mm stroke),  $\pm 20$  kN load cell

**B206** 16 Channel Control and Data Acquisition System  
(CDAS) & TestLab software

**B270-12** Air reservoir assembly with membrane dryer

It requires pressurized air, minimum 7 bar (not included).



### B220-02 KIT

16 kN Servo-Pneumatic dynamic testing system (motorized crosshead) with **B221N** Temperature controlled cabinet

Model	B220-01 KIT	B220-02 KIT
B220-11	▼	
B220-12		▼
B206	▼	▼
B270-12	▼	▼

## TECHNICAL SPECIFICATIONS

### Load frame

- Between Columns 345 mm
- Vertical Space 650 mm

### Servo actuator

- Capacity  $\pm 16$  kN
- Frequency up to 70 Hz
- Stroke 30 mm
- Air supply clean dry air
- Pressure 800-900 kPa
- Minimum rate up to 5 litres/sec

**Power Supply:** 90-264V 50-60Hz 1ph 240W (B220-11)  
230V 50Hz 1ph 100W (B220-12)  
230V 50Hz 1ph 1450W (B221)

**Dimensions:** 1262(h) x 400(d) x 470(w) mm B220-11 load frame  
1262(h) x 400(d) x 510(w) mm B220-12 load frame  
2170(h) x 840(d) x 760(w) mm load frame with  
temperature controlled cabinet

**Weight:** 80 kg load frame B220-11 load frame  
125 kg load frame B220-12 load frame  
160 kg temperature controlled cabinet



**B220-02 KIT**  
DTS-16 detail

**B220-12**  
20 kN Load frame with motorized  
crosshead

## TECHNICAL FEATURES

### ■ Optional motorized crosshead.

A motorized crosshead allows an easier test set-up in terms of accessories positioning without using any extension rods.

### ■ Latest technology.

The DTS-16 advantage revolves around the Control Data Acquisition System (CDAS) and TestLab Software.

### ■ Durable powder coated aluminium base plate with stainless steel work platen.

### ■ Air reservoir assembly with membrane dryer.

It allows a great insurance against damages to the servo-valve in case of moisture in the compressed air.

## RECOMMENDED ACCESSORIES

**B221N** Temperature controlled cabinet: -20 °C to +70 °C  
to suit DTS-16 or 4PBA

**B250-07 KIT** Temperature measuring kit comprising:

■ **B292-01** Temperature transducer (-80 °C to +80 °C)  
(2 pieces)

■ **B250-10** Dummy asphalt specimen

■ **B250-11** 100 mm "O" ring (3 pieces)

■ **B250-12** Thermal conducting grease (about 56 g)

**H009-01EN** PC complete with LCD monitor 22", keyboard,  
mouse, cables and installation of Testlab software

**B270-12**  
Air reservoir assembly  
with membrane dryer



**B250-07 KIT**  
Temperature measuring kit

We can upgrade your existing UTM (also from other manufacturers)

For test configurations and related jigs, please consult p.182-192



**B230****30 KN SERVO-HYDRAULIC DYNAMIC TESTING SYSTEM (DTS-30)**

The DTS-30 Dynamic Testing System is a servo-hydraulic testing machine utilizing digital control of a high performance servo valve to provide accurate loading wave shapes up to 100 Hz. The DTS-30 can be operated in tension, compression dynamic loading and is suited to testing a diverse range of materials such as asphalt, soil, unbound granular materials, fibres and plastics. The DTS-30 is underpinned by Pavetest's leading edge CDAS digital controller, TestLab software and a full complement of accessories, hardware and software in perfect unison.

**The DTS-30 Dynamic Testing System is compact, fully integrated, user and environmentally friendly.**

**MAIN FEATURES**

- Compact, robust load frame.
- Small footprint; 90 cm x 135 cm, including hydraulic power supply and climatic chamber.
- Reaction frame embedded in the test chamber.
- Portable temperature control unit.
- Fully configurable to suit a large range of testing applications.
- Digital Servo-Hydraulic control.
- Dynaflo™ HPS provides dynamic speed control of the pump motor ensuring quiet operation.
- 4 axis control and 16 channel data acquisition as standard.

The machine includes:

- Rigid two column load frame
- 30 kN Servo-hydraulic actuator (100 mm Stroke)
- 2.2 kW Hydraulic Power Supply
- 16 Channel Control and Data Acquisition System (CDAS) & TestLab software
- Load cell ( $\pm 30$  kN)
- 100 mm actuator LVDT

**B230 30 KN**

Servo-Hydraulic

Dynamic Testing System with B231 temperature controlled cabinet

## TECHNICAL SPECIFICATIONS

### Load frame

- Between Columns 600 mm
- Vertical Space 800 mm

### Servo actuator

- Capacity  $\pm 30$ kN static,  $\pm 25$ kN dynamic
- Frequency up to 100Hz
- Stroke 100 mm

### Hydraulic Power Supply

- Pressure up to 160 bar, user defined
- Flow rate up to 7.5 litres/min
- Dimensions: 650(h) x 550(d) x 450(w) mm
- Power Supply: 230V 50-60Hz 1ph 2.5kW

### Power Supply:

- 230V 50-60Hz 1ph 2.5kW (B230)
- 230V 50Hz 1ph 1.3kW (B231)
- 230V 50Hz 1ph 3.1kW (B232)

### Dimensions:

- 2100(h) x 1220(d) x 800(w) mm load frame
- 2100(h) x 1800(d) x 800(w) mm with temperature controlled cabinet

### Weight:

- 430 kg approx. load frame
- 650 kg approx. load frame with temperature controlled cabinet and oil-filled HPS

## TECHNICAL FEATURES

- **The DTS-30 fatigue rated, servo-hydraulic actuator utilizes metal labyrinth bearings and seals.**  
The labyrinth bearings and seals are designed to reduce friction and maintain low operating temperatures. The bearings experience little-to-no wear, operate at high speeds and offer a long service life.
- **A bottom loading machine.** Before this current crop of universal testing machines, many dynamic testing machines were bottom loading. More recently, the Asphalt Mixture Performance Tester (AMPT) changed the mindset of the testing community by highlighting the benefits of a bottom loading machine.
- **Portable temperature control unit.** The temperature control unit attaches to the test chamber using a magnetic seal and can be wheeled away when not required or for servicing. It can be removed without dismantling the machine or disrupting the testing program.

## NEEDED ACCESSORIES

- B231** Temperature controlled cabinet:  
-20 °C to +80 °C to suit DTS-30 or DTS-130  
or
- B232** Temperature controlled cabinet:  
-40 °C to +80 °C to suit DTS-30 or DTS-130
- B233** Temperature controlled cabinet:  
-50 °C to +100 °C to suit DTS-30 or DTS-130

These temperature controlled cabinets may be supplied with humidity control, if required.

## RECOMMENDED ACCESSORIES

- H009-01EN** PC complete with LCD monitor 22", keyboard, mouse, cables and installation of Testlab software
- B250-07 KIT** Temperature measuring kit comprising:
  - **B292-01** Temperature transducer (-80 °C to +80 °C) (2 pieces)
  - **B250-10** Dummy asphalt specimen
  - **B250-11** 100 mm O ring (3 pieces)
  - **B250-12** Thermal conducting grease (about 56 g)

We can upgrade your existing UTM (also from other manufacturers)

For test configurations and related jigs, please consult p. 182-192

**Can't see the Control and Data Acquisition System (CDAS)?** That's because it's housed neatly, in the cabinet in front of the machine.

You won't see a tangle of cables either; they enter the cabinet through the floor of the test chamber or through the back of the cabinet and connect to the CDAS.

The door of the cabinet can be held ajar to allow transducers to be re-allocated or opened completely for servicing. Unused transducers can also be stored out of harm's way.

Moreover, the DTS-30 reaction frame is symmetrical; **the servo-hydraulic actuator and reaction shaft can be interchanged to make the DTS-30 top loading.**



**B206** 16 Channel CDAS

## B240 130 kN SERVO-HYDRAULIC DYNAMIC TESTING SYSTEM (DTS-130)

The DTS-130 Dynamic Testing System is a servo-hydraulic testing machine utilizing digital control of a high performance servo valve to provide accurate loading wave shapes up to 100 Hz. The DTS-130 is Pavetest's highest capacity Dynamic Testing System and completes the range of standard universal testing machines. The system can be operated in tension, compression dynamic loading and is suited to testing a diverse range of engineering materials and/or large asphalt specimens at very cold temperatures.

The DTS-130 is underpinned by Pavetest's leading edge CDAS digital controller, TestLab software and a full complement of accessories, hardware and software in perfect unison.

### MAIN FEATURES

- Robust two column load frame.
- Double acting servo hydraulic, equal area type with low friction, long life bearings and seals.
- Portable temperature control unit.
- Fully configurable to suit a large range of testing applications.
- Digital Servo-Hydraulic control.
- Dynaflo™ HPS variable frequency drive (VFD) provides dynamic speed control of the pump motor ensuring quiet operation.
- 4 axis control and 16 channel data acquisition as standard.

The machine includes:

- Rigid two column load frame
- 130 kN Servo-hydraulic actuator (100 mm Stroke)
- 10 kW Hydraulic Power Supply
- 16 Channel Control and Data Acquisition System (CDAS) & TestLab software
- Load cell ( $\pm 130$  kN)
- 100 mm actuator LVDT



### B240

130 kN Servo-Hydraulic Dynamic Testing System  
with **B231** temperature controlled cabinet

## TECHNICAL SPECIFICATIONS

### Load frame:

- Horizontal Space: 60 cm
- Vertical Space: 100 cm

### Servo actuator:

- Capacity:  $\pm 130\text{kN}$  Static  $\pm 100\text{kN}$  Dynamic
- Frequency: Up to 100Hz
- Stroke: 100 mm

### Hydraulic Power Supply:

- Pressure: Up to 210 bar, user defined
- Flow rate: 20 litres/min
- Dimensions: 1150 (h) x 600 (d) x 1100 (w) mm
- Power supply: 380V 50Hz or 208V 60Hz 12kW 3ph

### Power Supply:

- 380V 50Hz 3ph + neutral 12kW or
- 208V 60Hz 3ph + 12kW (B240)
- 230V 50Hz 1ph 1.3kW (B231)
- 230V 50Hz 1ph 3.1kW (B232)

### Dimensions:

- 3005 (h) x 1070 (d) x 1090 (w) mm load frame
- 3005 (h) x 1630 (d) x 1090 (w) mm with temperature controlled cabinet

### Weight:

- 680 kg approx. load frame
- 1360 kg approx. load frame with temperature controlled cabinet and oil-filled HPS



**B240** 130 kN Servo-Hydraulic Dynamic Testing System with **H009-01EN** complete PC, **B231** Temperature controlled cabinet, **B240-03** Exchanger oil/water, HPS (hydraulic power supply)

ACCESSORIES		B240-02 Exchanger oil/air	B240-03 Exchanger oil/water *
<b>B240-04</b>	Chiller for water refrigeration (recommended)		▼
<b>B240-05</b> or <b>B240-06</b>	Set of hoses to connect frame - pumping unit Lg. 3 m (needed) Set of hoses to connect frame - pumping unit Lg. 8 m (needed)	▼ ▼	▼ ▼
<b>B240-07</b> or <b>B240-08</b>	Set of hoses to connect pumping unit - Exchanger oil/air Lg. 5 m (needed) Set of hoses to connect pumping unit - Exchanger oil/air Lg. 10 m (needed)	▼ ▼	
<b>B240-09</b> or <b>B240-10</b>	Set of hoses to connect Exchanger oil/water - Chiller Lg. 5 m (recommended) Set of hoses to connect Exchanger oil/water - Chiller Lg. 10 m (recommended)		▼ ▼

\* (complete with set of hoses to connect pumping unit Exchanger oil/water)

The **Hydraulic Power Supply (HPS)** utilizes a variable flow pump with a working pressure up to 210 Bar. The customer can choose either water (heat exchanger) or air (Electric fan) oil cooling. Features include; low oil, over temperature and dirty filter indication, remote starting and user selectable working pressure (via TestLab).

**B231** Temperature controlled cabinet:  
-20 °C to +80 °C to suit DTS-30 or DTS-130

or

**B232** Temperature controlled cabinet:  
-40 °C to +80 °C to suit DTS-30 or DTS-130

**B233** Temperature controlled cabinet:  
-50 °C to +100 °C to suit DTS-30 or DTS-130

These temperature controlled cabinets may be supplied with humidity control, if required.

We can upgrade your existing UTM (also from other manufacturers)

## RECOMMENDED ACCESSORIES

- H009-01EN** PC complete with LCD monitor 22", keyboard, mouse, cables and installation of Testlab software
- B250-07 KIT** Temperature measuring kit (refer to p. 177)

For test configurations and related jigs, please consult p. 182-192

## TWO PIECE TEMPERATURE CONTROLLED CABINET

Pavetest offers a range of temperature controlled cabinet to complement our **DTS-30** and **DTS-130** servo-hydraulic Dynamic Testing Systems (DTS). **Pavetest is the first manufacturer to adopt a two piece temperature controlled cabinet**; comprising an insulate cabinet and a temperature control unit. The cabinet is permanently mounted on the dynamic testing machines, whilst the temperature control unit can be wheeled away when not required, leaving the back of the chamber open to accommodate longer jigs/specimens that do not require a controlled environment. The temperature control unit attaches to the cabinet using a magnetic seal. This isolates the cabinet from mechanical vibrations caused by the refrigeration unit and circulation fans whilst maintaining an air tight seal between the inside and outside of the chamber. This concept also makes servicing, replacing or upgrading the temperature control unit virtually effortless, because it can be removed with-out dismantling the machine or disrupting the testing program.

### MAIN FEATURES

- Two piece concept makes servicing, replacing or upgrading the temperature control unit effortless.
- Flexible temperature sensor ensures the temperature near the specimen is accurately controlled.
- Operator can monitor, set, adjust or “Auto tune” the temperature controller via the PC.
- Heavy duty stainless steel construction.
- Powerful re-circulation fans ensure even temperature through-out the chamber.
- Triple Glazed, Argon filled, Lo E glass door with built in heater.



Two piece temperature controlled cabinet

## ORDERING INFORMATION

**B231** Temperature controlled cabinet:  
-20 °C to +80 °C to suit DTS-130

or

**B232** Temperature controlled cabinet:  
-40 °C to +80 °C to suit DTS-130

**B233** Temperature controlled cabinet:  
-50 °C to +100 °C to suit DTS-30,  
supplied with humidity control, if required

Other temperature ranges and operating voltage/frequency available on request.

The temperature controller can be programmed using the virtual pendant within TestLab software, via a serial link between the temperature controller and the Control and Data Acquisition System (CDAS). This allows the operator to monitor, set or adjust a constant temperature or ramp without touching the temperature controller, including invoking the “Auto tune” function. This feature is particularly useful for the TSRST test, where programming the temperature controller is not a simple task.



Temperature controller sensor

Pavetest has introduced some additional features to improve the functionality of our temperature controlled cabinets. **The sensor for the temperature controller is mounted on a flexible arm** which allows the operator to locate the sensor in the vicinity of the test specimen; providing accurate temperature control where it's needed most; right near the specimen.



Cabinet switches and temperature controllers

## A TWO PIECE TEMPERATURE CONTROLLED CABINET

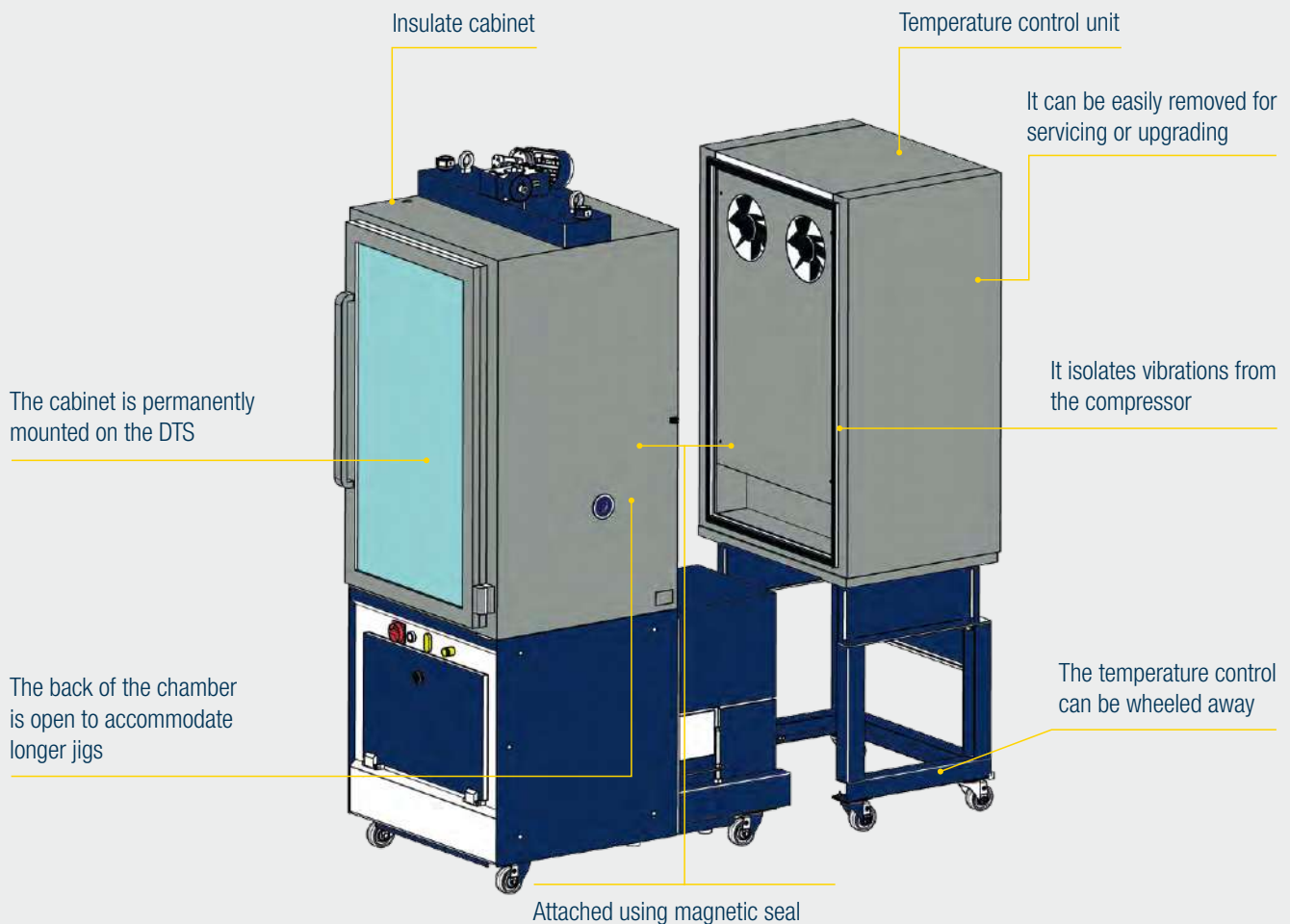

## DYNAMIC TEST CONFIGURATIONS

### B250 KIT INDIRECT TENSILE MODULUS - IDTM

STANDARDS: AASHTO TP31 Resilient modulus of bituminous mixtures by indirect tension  
 ASTM D4123 Indirect Tension Test for Resilient Modulus of Bituminous Mixtures  
 AS/NZS 2891.13.1 Resilient modulus of asphalt - Indirect tensile method  
 EN 12697-26 Annex C - Indirect tension to cylindrical specimens (IT-CY)

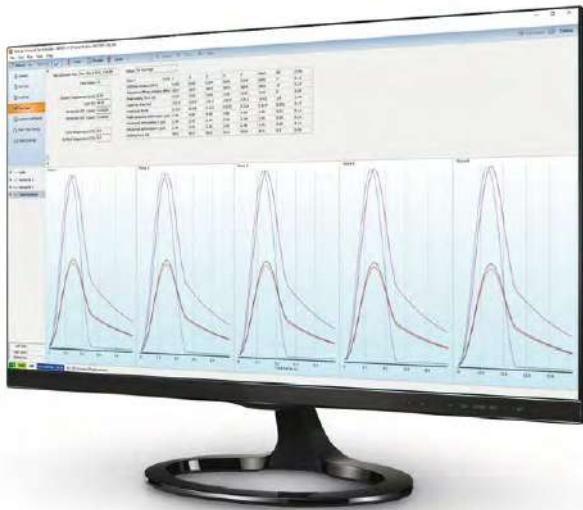

#### TEST FRAMES

Manual DTS-16 | Motorized DTS-16 (B221)  
 DTS-30 | DTS-130 (B231 or B232)



#### B250 KIT Indirect Tensile Modulus

Comprises:

- B250-01** Basic IDT Jig
- B250-08** Yoke
- B250-09** Assembly for B250 KIT
- B290-01** LVDT (0.2 mm) (2 pieces)

#### ACCESSORIES

- B250-03** Asphalt proving ring
- B250-04** 100 mm diameter PVC specimen
- B250-05** 150 mm diameter PVC specimen
- B250-06 KIT** Torque screwdriver (B250-13) with hexagonal head 4 mm (B250-14)

### B251 KIT INDIRECT TENSILE FATIGUE - IDTF

STANDARD: EN 12697-24 Annex E – Indirect tensile test on cylindrical shaped specimens



#### TEST FRAMES

Manual DTS-16 | Motorized DTS-16 (B221)  
 DTS-30 | DTS-130 (B231 or B232)



#### B251 KIT Indirect Tensile Fatigue

Comprises:

- B250-01** Basic IDT Jig
- B290-03** LVDT, double ball ended (3.75 mm) (2 pieces)
- B251-01** LVDT mounting strip gluing jig

#### ACCESSORIES

- B251-51** Pair of LVDT mounting strip to suit 100 mm specimen (**needed** accessory)

And/or

- B251-52** Pair of LVDT mounting strip to suit 150 mm specimen (**needed** accessory)
- B201-52** 5 Minute, two part epoxy 24 ml

## B260 KIT UNIAXIAL CYCLIC COMPRESSION - UCC

STANDARD: EN 12697-25 Cyclic compression. Test Method A - Uniaxial cyclic compression test with confinement  
 TP Asphalt-StB 25A1: Dynamic punching test on mastic asphalt  
 TP Asphalt-StB 25A2: Dynamic punching test on rolled asphalt



### B260 KIT Uniaxial cyclic compression

Comprises:

- B260-01** Base assembly
- B260-02** Chamfered top platen
- B290-02** LVDT (10 mm) (2 pieces)

### ACCESSORY

- B260-05** Upper loading platen in accordance with method A2 EN 12697-25
- B260-06** 56.4 mm top loading platen for TP Asphalt-STB Part 25A1
- B260-07** 80 mm top loading platen for TP Asphalt-STB Part 25A2

### TEST FRAMES

Manual DTS-16 | Motorized DTS-16 (B221)  
 DTS-30 | DTS-130 (B231 or B232)

## B260-10 PULL OFF TENSION JIG

STANDARD: TP Asphalt-StB – Part 81, Adhesive pull strength of thin asphalt layers

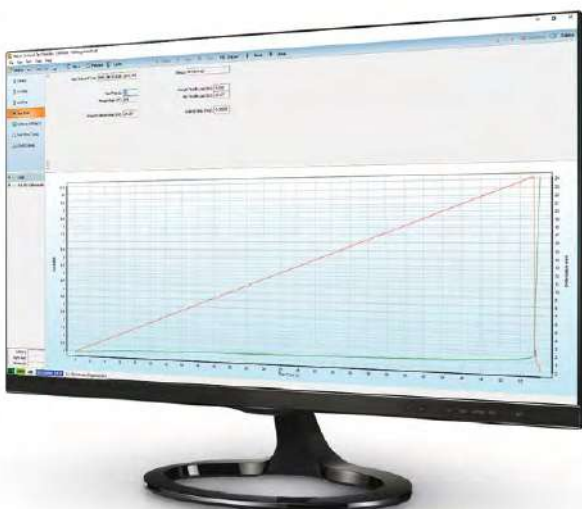

**B260-10** Pull off tension jig

### TEST FRAMES

DTS-30 (B231 or B232)

### ACCESSORY

- B261-01** DTS-30 Tension base (needed)



## B253 KIT INDIRECT TENSILE MODULUS, CREEP COMPLIANCE AND STRENGTH USING ON-SPECIMEN TRANSDUCERS - IDTOS

STANDARDS: ASTM D7369 Resilient Modulus of Bituminous Mixtures by Indirect Tension Test  
AASHTO T322 Creep Compliance and Strength of Hot-Mix Asphalt (HMA)  
Using the Indirect Tensile Test Device

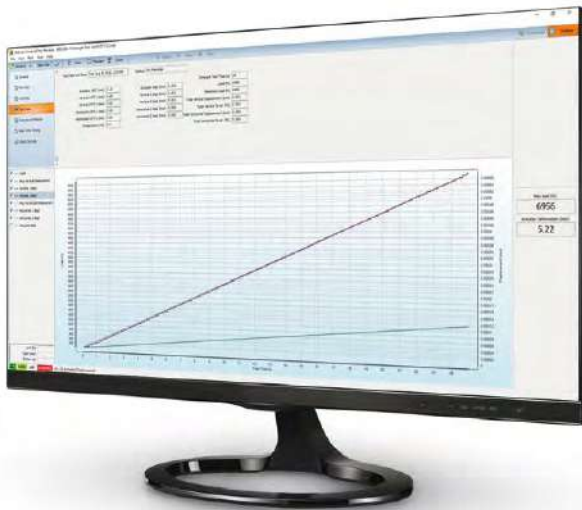

**B253 KIT** Indirect Tensile modulus, creep compliance and strength using on-specimen transducers

Comprises:

**B250-01** Basic IDT Jig

**B253-01** AASHTO T322 LVDT mounting Jig

**B290-04** Miniature LVDT (1 mm) (4 pieces)

**B253-02** AASHTO T322 gauge point template (100 mm specimen)

**B253-03** AASHTO T322 gauge point template (150 mm specimen)

### TEST FRAMES

Manual DTS-16 | Motorized DTS-16 (B221)  
DTS-30 | DTS-130 (B231 or B232)

### ACCESSORIES

**B253-53** Gauge point (24 needed pieces)

**B201-52** 5 Minute, two part epoxy 24 ml

## B212 FOUR POINT BENDING FOR USE WITH PAVETEST B230 - 4PB

STANDARDS: AASHTO T 321 Fatigue Life of Compacted Hot-Mix Asphalt (HMA) Subjected to Repeated Flexural Bending  
ASTM D7460 Fatigue Failure of Compacted Asphalt Concrete Subjected to Repeated Flexural Bending  
AG:PT/T233 & ASTM 03 Fatigue life of compacted bituminous mixes subject to repeated flexural bending  
EN 12697-24 Annex D - Four point bending test on prismatic shaped specimens  
EN 12697-26 Annex B - Four point bending test on prismatic specimens (4PB-PR)

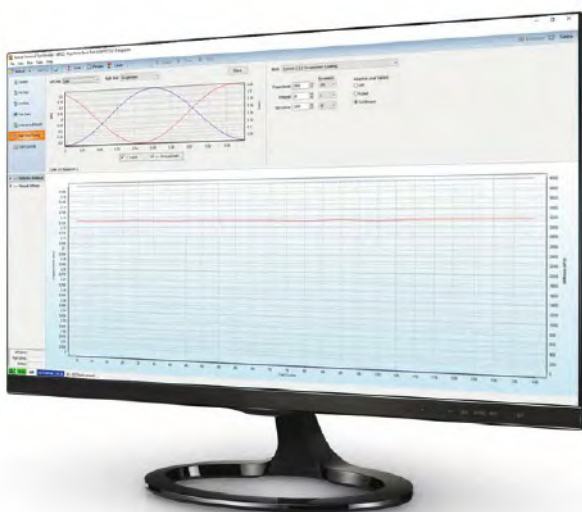

### TEST FRAMES

DTS-30 (B231 or B232)

### ACCESSORIES

**B210-02** 4PB PVC Beam

**B210-03** 4PB Reference beam

## B280 KIT TWO POINT BENDING (2PB) TO SUIT B230 - 2PB

STANDARDS: EN 12697-24 Annex A - Two-point bending test on trapezoidal shaped specimens (2PB-TR)  
EN 12697-26 Annex A - Two point bending test on trapezoidal specimens (2PB-TR)

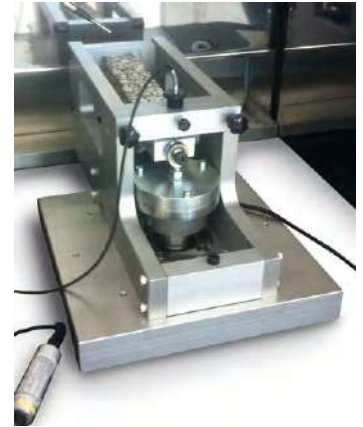
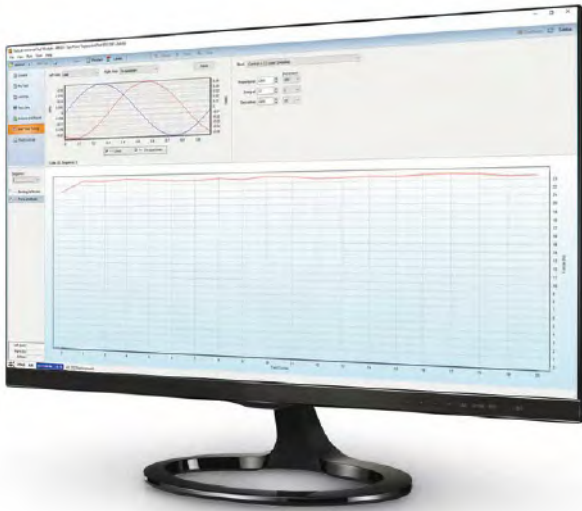

**B280 KIT** Two Point Bending (2PB) to suit B230.  
Comprises:

- B280-01** 2PB Jig
- B280-51** 2PB Mounting plate (25 mm apex)
- B280-52** 2PB Mounting plate (50 mm apex)
- B280-53** 2PB Mounting plate (base)

### TEST FRAMES

DTS-30 (B231 or B232)

### ACCESSORIES

- B290-05** LVDT (2 mm) (**needed** accessory)
- B280-02** Two point Bending (2PB) gluing jig (**needed** accessory)
- B201-52** 5 Minute, two part epoxy 24 ml

## B261 KIT PERMANENT DEFORMATION - PD

STANDARD: AS/NZS 2891.12.1 Determination of the permanent compressive strain characteristics of asphalt - Dynamic creep test  
TP Asphalt-StB – Part 25B Uniaxial pressure-fatigue testing. Determination of deformation behavior of roller asphalt during heat

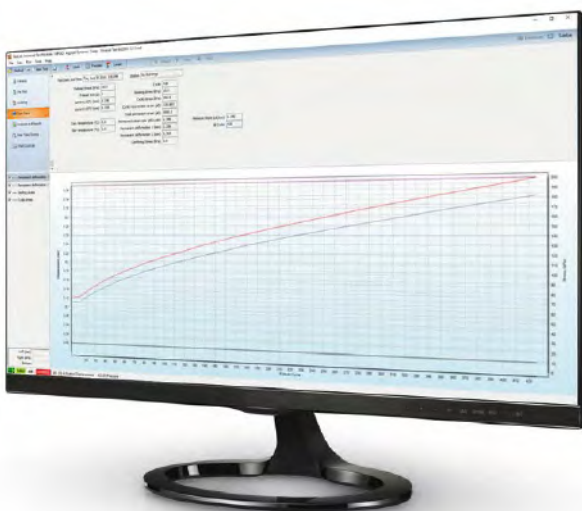

**B261 KIT**

**B262 KIT**

**B261 KIT** Permanent deformation  
Comprises:

- B260-01** Base assembly
- B260-03** 100 mm top platen
- B290-02** LVDT (10 mm) (2 pieces)

### TEST FRAMES

Manual DTS-16 | Motorized DTS-16 (B221)  
DTS-30 | DTS-130 (B231 or B232)

### ACCESSORY

- B260-04** 150 mm top platen

## B255 KIT DYNAMIC MODULUS - E\*

STANDARD: AASHTO T342 Determining Dynamic Modulus of Hot Mix Asphalt (HMA)

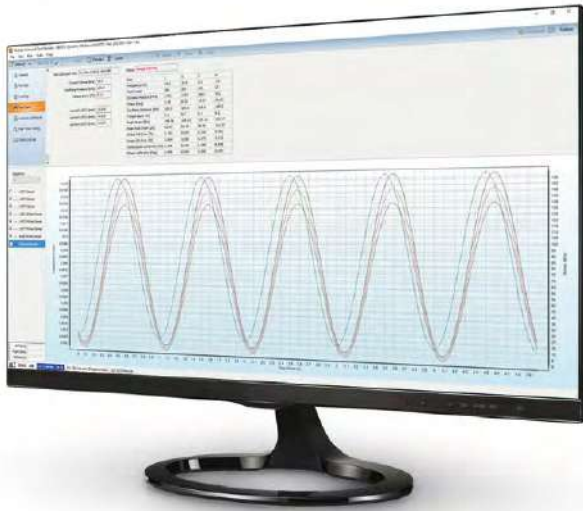

### B255 KIT Dynamic modulus

Comprises:

- B200-02** 105 mm bottom loading platen
- B200-03** 105 mm top loading platen
- B253-04** AASHTO T342 LVDT mounting jig (3 pieces)
- B290-06** LVDT (1 mm) (3 pieces)
- B253-05** Screwdriver hex bit with spherical head size 2 mm

### TEST FRAMES

DTS-30 | DTS-130 (B231 or B232)

### ACCESSORIES

- B202** Gauge Point Fixing Jig
- B203** Dynamic Verification Device
- B253-53** Gauge point (24 **needed** pieces)
- B201-52** 5 Minute, two part epoxy 24 ml

### DYNAMIC MODULUS ON SMALL SPECIMENS | DTS-30/130

To test 38 mm (diameter) x 110 mm (h) specimens with DTS-30/130, the following items are required

- B200-05** Bottom loading platen for 38 x 110 mm ( $\emptyset$  x h) specimen
- B200-06** Top loading platen for 38 x 110 mm ( $\emptyset$  x h) specimen
- B253-04** AASHTO T342 LVDT mounting jig (3 pieces)
- B290-06** LVDT (1 mm) (3 pieces)
- B253-53** Gauge point (24 needed pieces)
- B253-05** Screwdriver hex bit with spherical head size 2 mm
- B202** Gauge Point Fixing Jig
- B202-02** Spacer for 110 mm specimen height to be used with gauge point fixing jig B202
- B202-03** 38 mm and 50 mm diameter specimen - extension for gauge point fixing jig plungers B202
- B203** Dynamic Verification Device (optional)
- B201-52** 5 Minute, two part epoxy 24 ml (optional)

To test 50 mm (diameter) x 135 mm (h) specimens with DTS-30/130, the following items are required:

- B200-07** Bottom loading platen for 50 x 135 mm ( $\emptyset$  x h) specimen
- B200-08** Top loading platen for 50 x 135 mm ( $\emptyset$  x h) specimen
- B253-04** AASHTO T342 LVDT mounting jig (3 pieces)
- B290-06** LVDT (1 mm) (3 pieces)
- B253-53** Gauge point (24 needed pieces)
- B253-05** Screwdriver hex bit with spherical head size 2 mm
- B202** Gauge Point Fixing Jig
- B202-01** Spacer for 135 mm specimen height to be used with gauge point fixing jig B202
- B202-03** 38 mm and 50 mm diameter specimen - extension for gauge point fixing jig plungers B202
- B203** Dynamic Verification Device (optional)
- B201-52** 5 Minute, two part epoxy 24 ml (optional)

## B271 KIT CYCLIC TRIAXIAL COMPRESSION - CCT

STANDARD: EN 12697-25 Cyclic compression. Test Method B - Triaxial cyclic ompression test



### TEST FRAMES

Manual DTS-16 | Motorized DTS-16 (B221)  
DTS-30 | DTS-130 (B231 or B232)

**B271 KIT** Cyclic triaxial compression  
Comprises:

- B270-01** Triaxial cell, suitable for  $\varnothing$  100 mm, up to 200 mm height specimens
- B270-02** Triaxial cell external LVDT mounting jig
- B293-01** Pressure transducer ( $\pm$  300 kPa)
- B270-06** 110 mm diameter top loading platen for EN 12697-25B
- B270-15** 110 mm diameter base pedestal for 100 mm height specimen



### ACCESSORIES

- B290-02** Displacement transducer (10 mm) (2 pieces **needed**)
  - B270-04** Air reservoir assembly confining pressure upgrade kit (**needed** accessory for DTS-16)
- or
- B270-03** Air reservoir assembly with confining pressure control (**needed** accessory for DTS-30/130)
  - B270-17**  $\varnothing$  200 mm base plate (**needed** accessory for DTS-30)
  - B270-18** Membrane stretcher for asphalt specimen  $\varnothing$  100 mm
  - B201-53**  $\varnothing$  100 mm rubber membrane 0.3 mm thickness (pack of 10)
  - S311-03**  $\varnothing$  100 mm sealing ring (10 pieces)
  - S316-03**  $\varnothing$  100 mm porous disc (2 pieces) needed for AASHTO T307  
Requires pressurized air, minimum 7 bar (not included)

## B272 KIT TRIAxIAL RESILIENT MODULUS - TRM

STANDARD: AASHTO T307 Determining the resilient modulus of soils and aggregate materials

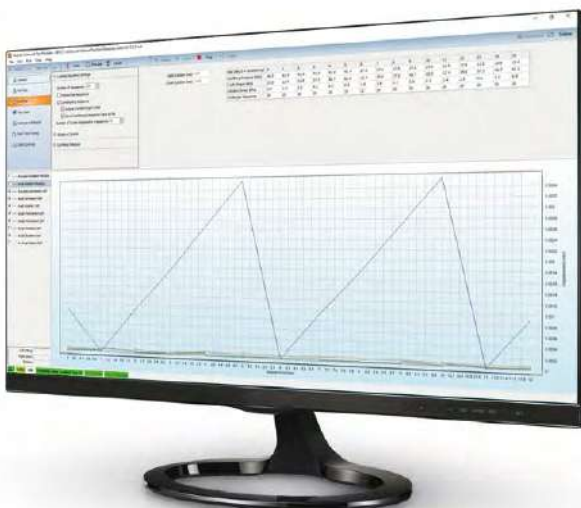

### TEST FRAMES

Manual DTS-16 | Motorized DTS-16 (B221)  
DTS-30 | DTS-130 (B231 or B232)

**B272 KIT** Triaxial resilient modulus  
Comprises:

- B270-01** Triaxial cell, suit able for  $\varnothing$  100 mm, up to 200 mm height specimens
- B270-02** Triaxial cell external LVDT mounting jig
- B293-02** Pressure transducer ( $\pm$  600 kPa)
- S315-07** 100 mm diameter bottom platen
- S314-03** 100 mm diameter top platen



### ACCESSORIES

Same accessories of B271 KIT

## B274-KIT TRIAxIAL TESTING KIT

STANDARDS: AASHTO T378-17 Standard Method Test for Determining the Dynamic Modulus and Flow Number for Hot Mix Asphalt (HMA)  
AASHTO T378 Standard Method of Test for Determining the Dynamic Modulus and Flow Number for Asphalt Mixtures

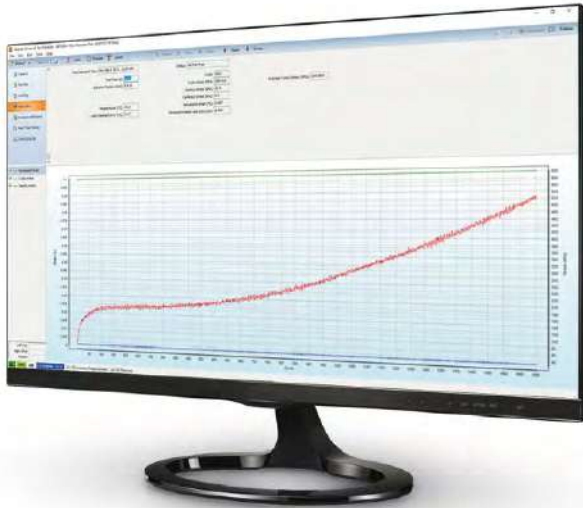

### TEST FRAMES

Manual DTS-16 | Motorized DTS-16 (B221)  
DTS-30 | DTS-130 (B231 or B232)

### B274 KIT Triaxial testing Kit

Comprises:

- B270-01** Triaxial cell, suitable for  $\varnothing$  100 mm x up to 200 mm tall
- B293-01** Pressure transducer ( $\pm$  300kpa)
- B200-03** 105 mm top loading platen
- B270-16**  $\varnothing$  105 mm base pedestal for 150 mm height specimen



### ACCESSORIES

- B200-01** AMPT LVDT 2.00 mm (3 needed)
  - B270-04** Air reservoir assembly confining pressure upgrade jig (needed for DTS-16)
- or
- B270-03** Air reservoir assembly with confining pressure control (needed for DTS-30/130)
  - B253-53** Gauge point (24 pieces needed)
  - B201-52** 5 minute, two part epoxy 24 ml
  - S311-03** Sealing ring  $\varnothing$  100 mm
  - B201-53** 100 mm rubber membrane 0.3 mm thickness (pack of 10)
  - B202** Gauge point fixing jig
  - B203** AMPT dynamic verification device
  - B200-10** Latex membrane material cut in  $\varnothing$  100 mm discs (needed for AASHTO T378)

Requires pressurized air, minimum 7 bar (not included)

## B254 KIT SEMI-CIRCULAR BENDING - SCB

STANDARD: EN 12697-44 Tensile Strength and Fracture Toughness-Crack Propagation

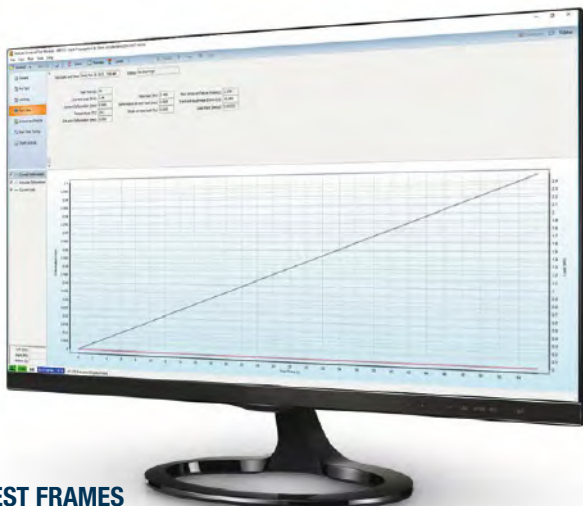

### TEST FRAMES

Manual DTS-16 | Motorized DTS-16 (B221)  
DTS-30 | DTS-130 (B231 or B232)

### B254 KIT EN SCB testing kit

Comprises:

- B254-01** SCB jig
- B254-51** Pair of SCB wear plates



### ACCESSORIES

- B250-01** Basic Indirect Tensile Jig (**needed** accessory)
- B290-07** Deformation gauge
- B290-02** Displacement transducer (10 mm) (2 optional pieces)

## B254-02 KIT AASHTO | ASTM SCB TESTING KIT

STANDARDS: AASHTO TP 124 Determining the fracture potential of asphalt mixtures using semicircular bend geometry (SCB) at intermediate temperature

ASTM D8044 Evaluation of asphalt mixture cracking resistance using the semi-circular bend test (SCB) at intermediate temperature

AASHTO TP105 Determining the fracture energy of asphalt mixtures using the semicircular bend geometry (SCB)

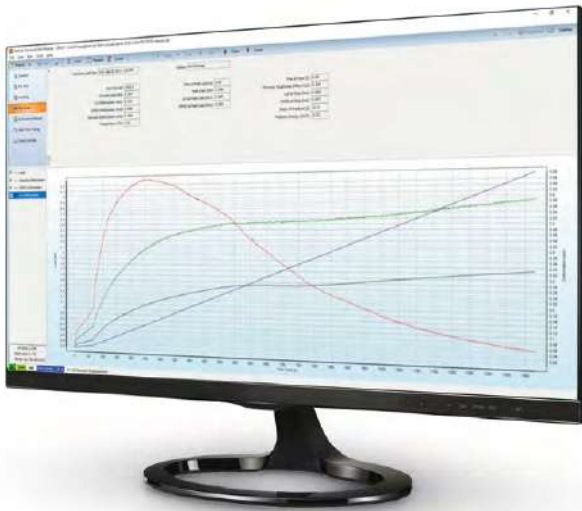

### TEST FRAMES

DTS-30 | DTS-130

### B254-02 KIT AASHTO | ASTM SCB testing kit

Comprises:

- B208** SCB frame
- B254-10** Roller support
- B254-02** Springs and roller



### OPTIONAL ACCESSORIES for AASHTO TP 124, ASTM D8044

- B290-02** LVDT (10mm) (1 or 2)
- B254-11** LVDT mounting assembly (q,ty according to B290-02)
- B254-12** Positioning device

### NEEDED ACCESSORIES for AASHTO TP105

- B254-13** Gauge point template
- B254-14** LVDT mounting hardware (2 **needed**)
- B254-15** LVDT mounting frame (2 **needed**)
- B253-53** Gauge point (2 **needed**)
- B290-05** LVDT 2.00 mm (2 **needed**) or  
**B290-06** LVDT 1.00 mm (2 **needed**)
- B290-07** SCB deformation gauge or  
**B290-16** Epsilon (model 3541) clip-on gauge CMOD transducer -1/+2.5 mm + **C090-18** Knife edge (pack of 24 only for B290-16)

## B282 KIT THERMAL STRESS RESTRAINED SPECIMEN TEST - TSRST

STANDARDS: AASHTO TP10 Thermal Stress Restrained Specimen Tensile Strength  
EN 12697-46 Low Temperature Cracking and Properties by Uniaxial Tension  
TP Asphalt-StB 46A Cold properties: uniaxial tensile stress test and thermal stress restrained specimen test



### TEST FRAMES

DTS-30 | DTS-130 (B232)

### B282 KIT Thermal Stress Restrained Specimen Test

Comprises:

- B282-01** TSRST Temp Transducer (-80°C to +80°C) (3 pieces)
- B282-02** Rod End (2 pieces)
- B282-03** Clevis Yoke and Pin (2 pieces)
- B282-04** Platen (2 pieces)
- B282-05** LVDT Holder (2 pieces)
- B282-06** Invar Rod (250 mm long) (2 pieces)
- B282-07** Multi tack adhesive squares



### ACCESSORIES

- B290-09** Displacement transducer (5 mm) (2 pieces **needed**)
- B261-01** B230 tension base (**needed** accessory for DTS-30)
- B282-08** TSRST specimen gluing jig (1 piece **needed**)
- B201-52** 5 minute, two part epoxy 24 ml

## B284-01 DISK SHAPED COMPACT TENSION TEST KIT - DC(T)

STANDARD: ASTM D7313-07a Determining fracture energy of asphalt aggregate mixtures using the disk-shaped compact tension geometry

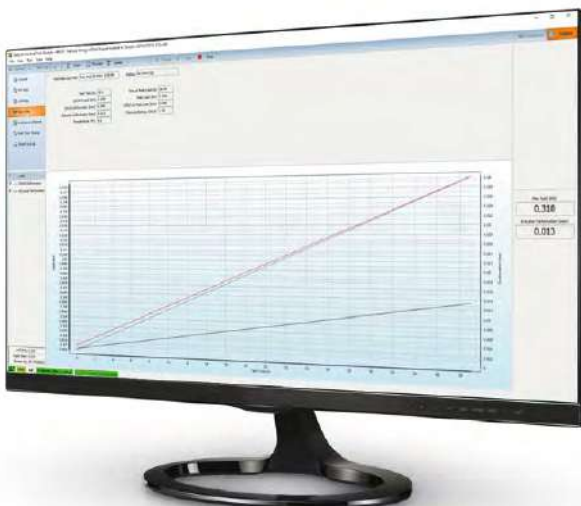

### TEST FRAMES

DTS-30 | DTS-130 (B231 or B232)

### B284-01 Disk Shaped Compact Tension Test Kit



### ACCESSORIES

- B261-01** B230 tension base (**needed** accessory for DTS-30)
- B290-07** Deformation gauge (**needed** accessory)
- or
- B290-12** Epsilon Clip-On gauge 12.5 mm +1/-7 mm (**needed** accessory)
- C090-18** Knife edge (Pack of 24) only for B290-12

## B264 KIT DIRECT TENSION TESTING KIT - DTT

STANDARDS: EN 12697-26 Annex E - Test applying direct tension to cylindrical specimens (DT-CY) or to prismatic specimens (DT-PR)  
 EN 12697-26 Annex D - Direct tension-compression test on cylindrical specimens (DTC-CY)  
 AASHTO TP 107-14 Standard Method of Test for Determining the Damage Characteristic Curve of Asphalt Mixtures from Direct Tension Cyclic Fatigue Tests

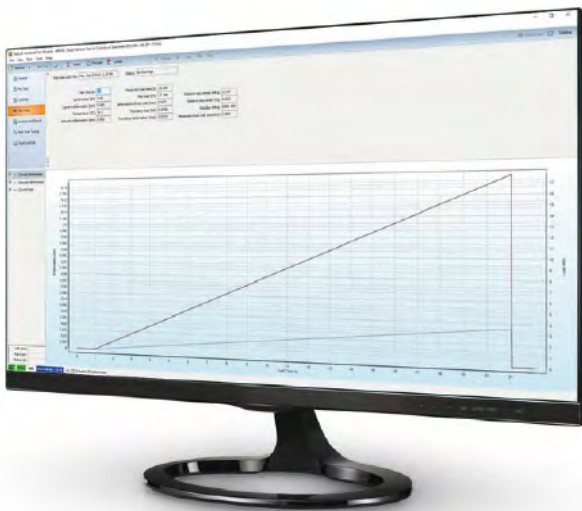

### TEST FRAMES

DTS-30 | DTS-130 (B232)



### B264 KIT Direct tension testing kit

Comprises:

- B261-02** Spherical seat coupling (2 pieces)
- B261-03** 100 mm tension platen (2 pieces)

### ACCESSORIES

- B253-04** LVDT mounting (3 pieces **needed**) jig
- B290-06** LVDT (1 mm) (3 pieces **needed**)
- B253-05** Screwdriver hex bit with spherical head size 2 mm
- B201-52** 5 Minute, two part epoxy 24 ml
- B202** Gauge point fixing jig
- B202-04** Spacer for 130 mm specimen height to be used with B202 (optional)
- B253-53** Gauge Point (24 pieces)
- B261-01** B230 tension base (**needed** accessory for DTS-30)

### AASHTO TP 107-14 ON SMALL SPECIMENS | DTS-30/130

To test 38 mm (diameter) x 110 mm (h) specimens with DTS-30/130 unit, the following items are required:

- B200-11** 38MM AMPT tension platen (2 pieces needed)
- B261-02** Spherical seat coupling
- B202** Gauge Point Fixing Jig
- B202-02** Spacer for 110 mm specimen height to be used with gauge point fixing jig B202
- B202-03** 38 mm and 50 mm diameter specimen - extension for gauge point fixing jig plungers B202
- B253-04** LVDT mounting (3 pieces needed) jig
- B290-06** LVDT (1 mm) (3 pieces needed)
- B253-05** Screwdriver hex bit with spherical head size 2 mm
- B201-52** 5 Minute, two part epoxy 24 ml
- B253-53** Gauge Point (24 pieces)

To test 50 mm (diameter) x 135 mm (h) specimens with DTS-30/130 unit, the following items are required:

- B200-12** 50MM AMPT tension platen (2 pieces needed)
- B261-02** Spherical seat coupling
- B202** Gauge Point Fixing Jig
- B202-01** Spacer for 135 mm specimen height to be used with gauge point fixing jig B202
- B202-03** 38 mm and 50 mm diameter specimen - extension for gauge point fixing jig plungers B202
- B253-04** LVDT mounting jig (3 pieces needed)
- B290-06** LVDT (1 mm) (3 pieces needed)
- B253-05** Screwdriver hex bit with spherical head size 2 mm
- B201-52** 5 Minute, two part epoxy 24 ml
- B253-53** Gauge Point (24 pieces)



## B204 KIT OVERLAY KIT ACCORDING TO ASTM WK26816

STANDARD: ASTM WK26816 New Test Method for Determining the Susceptibility of Asphalt Mixtures to Cracking



### TEST FRAMES

Manual DTS-16 | Motorized DTS-16 (B221)  
DTS-30 | DTS-130 (B231 or B232)



**B204 KIT** Overlay kit according to ASTM WK26816

Comprises:

**B204-01** Overlay jig

**B204-02** Pair of overlay tester (OT) specimen plates

**B204-03** OT specimen preparation jig according to ASTM WK26816

### NEEDED ACCESSORIES

**B261-01** DTS-30 tension base

**B261-02** Spherical seat coupling

**B290-05** LVDT 2.00 mm or **B290-06** LVDT 1.00 mm

## B204-01 KIT OVERLAY KIT ACCORDING TO TEX-248-F

STANDARD: TxDOT Designation. TEX-248-F Test Procedure for Overlay Test

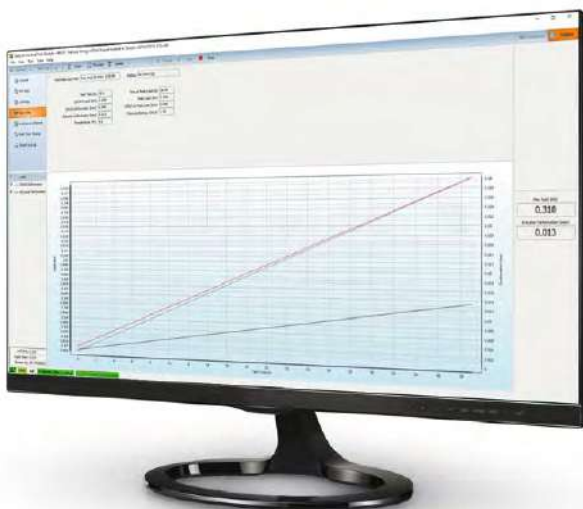

### TEST FRAMES

Manual DTS-16 | Motorized DTS-16 (B221)  
DTS-30 | DTS-130 (B231 or B232)



**B204-01 KIT** Overlay kit according to TEX-248-F

Comprises:

**B204-01** Overlay jig

**B204-02** Pair of overlay tester (OT) specimen plates

**B204-13** OT specimen preparation jig according to TEX-248-F

### NEEDED ACCESSORIES

**B261-01** DTS-30 tension base

**B261-02** Spherical seat coupling

**B290-05** LVDT 2.00 mm or **B290-06** LVDT 1.00 mm

## B210 KIT STAND-ALONE SERVO-PNEUMATIC FOUR POINT BENDING (4PB) SYSTEM

STANDARDS: EN 12697-24 Annex D | EN 12697-26 Annex B | AASHTO T321 | ASTM 03 | ASTM-D7460

The Pavetest Servo-pneumatic Four Point Bending (4PB) System is a servo-pneumatic testing machine utilizing digital control of a high performance servo valve to provide accurate loading wave shapes up to 60Hz. The 4PB system can be operated in haversine or sinusoidal, controlled strain or sinusoidal controlled stress mode to determine the flexural stiffness/modulus and resistance to fatigue of asphalt beams of various sizes.

### MAIN FEATURES

- Robust four point loading frame.
- Backlash free rotation and translation on all load and reaction points.
- Fully configurable to suit a large range of testing applications.
- High performance servo-valve.
- Long life pneumatic actuator.
- Digital Servo-pneumatic control.
- 2 axis control and 8 channel data acquisition.



**B210-01**  
Servo-pneumatic four point apparatus

**B210 KIT** comprises:

- **B210-01** Servo-pneumatic Four Point Bending (4PB) Device with 10 mm actuator LVDT,  $\pm 5$  kN load cell, and 2 mm On-specimen LVDT
- **B205** 8 Channel Control and Data Acquisition System (CDAS) & TestLab software
- **B270-12** Air reservoir assembly with membrane dryer

It requires pressurized air, minimum 7 bar (not included)

The 4PB System is underpinned by Pavetest's **leading edge CDAS digital controller**, TestLab software and a full complement of accessories, hardware and software in perfect unison.

## TECHNICAL SPECIFICATIONS

### Load frame

- Outer clamp span 355.5 mm (14") and 420 mm
- Nominal beam size(s): 50 mm (h) x 50 mm (w)  
50 mm (h) x 63.5 mm (w)  
70 mm (h) x 70 mm (w)  
70 mm (h) x up to 85 mm (w)

### Servo actuator

- Capacity  $\pm 5$  kN
- Frequency Up to 60Hz;
- Stroke 10 mm
- Air supply clean dry air
- Pressure 800-900 kPa
- Minimum rate up to 5 litres/sec

### On-specimen transducer

- Range  $\pm 1$  mm
- Resolution 0.0002  $\mu$ m
- Accuracy Better than 5  $\mu$ m

**Power Supply:** 90-264V 50/60Hz 1ph 240W (B210 KIT)

**Dimensions:** 590(h) x 250(d) x 570(w) mm (B210-01)  
410(h) x 250(d) x 570(w) mm (B212)

**Weight:** 45 kg approx. (B210-01)  
35 kg approx. (B212)

## NEEDED ACCESSORIES

- B210-02** 4PB PVC Beam
- B210-03** 4PB Reference beam
- B250-07 KIT** Temperature measuring kit comprising:
  - **B292-01** Temperature transducer (-80 °C to +80 °C) (2 pieces)
  - **B250-10** Dummy asphalt specimen
  - **B250-11** 100 mm O ring (3 pieces)
  - **B250-12** Thermal conducting grease (about 56 g)



**B210-02** PVC Beam

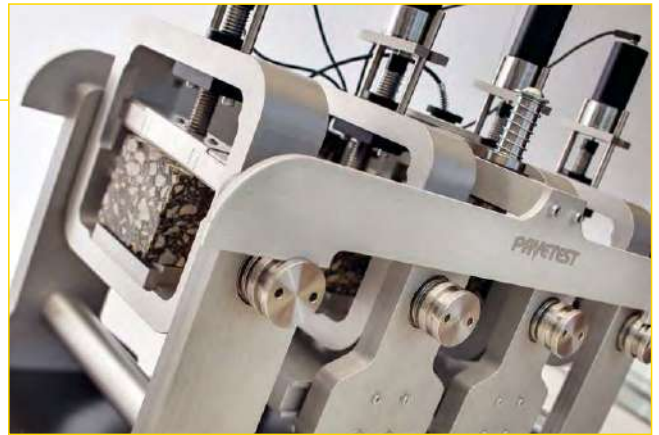

**B210-01** Servo-pneumatic four point apparatus, detail

## RECOMMENDED ACCESSORIES

- B221** Temperature controlled cabinet: -20 °C to +70 °C to suit DTS-16 or 4PBA
- H009-01EN** PC complete with LCD monitor 22", keyboard, mouse, cables and installation of Testlab software

### 4PBA on DTS16:

- B210-01** Servo-pneumatic Four Point Bending (4PB) device with 10 mm actuator LVDT,  $\pm 5$  kN load cell and 2 mm Onspecimen LVDT (sharing CDAS with DTS 16)

It requires pressurized air (not included).

### 4PBA on DTS30:

- B212** 4PB JIG (sharing CDAS with DTS 30)

### 4PBA on DTS130:

- B210-01** Servo-pneumatic Four Point Bending (4PB) device with 10 mm actuator LVDT,  $\pm 5$  kN load cell and 2 mm Onspecimen LVDT (sharing CDAS with DTS 130)

- B270-12** Air reservoir assembly with membrane dryer

It requires pressurized air (not included).



**B270-12**  
Air reservoir assembly with membrane dryer

The specimen is securely clamped using servo-motor driven ball screws to maintain the prescribed clamping force and accommodate any compliance of the specimen between the clamping surfaces, during the test. The clamping force is controlled by regulating the motor current.

An on-specimen (LVDT) displacement transducer is used to measure and control the deflection at the centre of the beam with respect to the outer load/reaction points, as prescribed in the relevant standards.

Specimen alignment guide

Specimen height spacer to adjust the height of the specimen



A low profile, high performance stainless steel ring torsion load cell is used to measure and control the load.

The servo-pneumatic system uses a bottom loading pneumatic actuator coupled to a high performance servo valve, with PID closed-loop control and run time adaptive control to achieve/maintain the requested strain/stress for the duration of the test.

Inner and outer clamp control switches, located on the front of the device, are used to activate and release the inner and outer specimen clamps. The four specimen yokes provide backlash free rotation and translation at all load and reaction points.

**B200****AMPT | SPT****ASPHALT MIXTURE PERFORMANCE TESTER**

COMPACT, FULLY SELF CONTAINED, PRECISION ENGINEERED UNIT

The Pavetest AMPT is a servo-hydraulically controlled testing machine specifically designed to perform the three asphalt tests developed under NCHRP Projects 9-19 and 9-29; Dynamic Modulus, Flow Number and Flow Time. It is also the prescribed equipment in AASHTO T378-17 Standard Method Test for Determining the Dynamic Modulus and Flow Number for Hot Mix Asphalt (HMA) using the Asphalt Mixture Performance Tester (AMPT). In addition, the Pavetest AMPT can also perform Direct Tension Cyclic Fatigue, Indirect Tensile Dynamic Modulus, Incremental Repeated Load Permanent Deformation, Semi-circular bend, and Overlay Testing of Asphalt Mixtures.

The Pavetest AMPT is underpinned by Pavetest's leading edge CDAS digital controller, TestLab software and a full complement of accessories, hardware and software in perfect unison.

**MAIN FEATURES**

- Thermoelectric (TE) Heating/Cooling  
More reliable and environmentally friendly than mechanical refrigeration & heating elements.
- The unit can be equipped with water cooled TE heating/cooling technology (optional).
- Magnetically mounted on-specimen transducer system, based on loose core LVDTs or optional epsilon extensometers.
- Gauge point fixing jig facilitates gluing gauge points and the (top and bottom) platens for proposed AMPT Direct Tension Cyclic Fatigue (S-VECD) Test.
- Dynamic Verification Device.
- Dynaflo™ HPS provides dynamic speed control of the pump motor ensuring quiet operation.
- Optional built-in, silent, air compressor with associated air preparation equipment.

The machine includes:

- 8 Channel Control and Data Acquisition System (CDAS) & TestLab software
- 30 mm Actuator LVDT
- Load cell ( $\pm 20$  kN)
- Pressure transducer ( $\pm 300$  kPa)
- Temperature transducer ( $-80$  °C to  $+ 80$  °C)
- Magnetically mounted on-specimen LVDT (2 mm) (3 pieces)
- 105 mm bottom loading platen
- 105 mm top loading platen

It requires pressurized air, minimum 7 bar (not included).



**B200** AMPT/SPT Asphalt Mixture Performance Tester

## TECHNICAL SPECIFICATIONS

<b>Load capacity:</b>	19kN (Static) - 17kN (Dynamic)
<b>Actuator stroke:</b>	30 mm
<b>Specimen size:</b>	100 mm (diameter) x 150 mm (h)
<b>Temperature range:</b>	0 °C to 70 °C (B200) -10 °C to 70 °C *(B200L)
<b>Confining pressure:</b>	0 to 225 kPa
<b>Noise level:</b>	Less than 70 db at 2 m
<b>Power Supply:</b>	230V 50-60Hz 1ph 3.5kW (B200   B200L)
<b>Dimensions:</b>	1510(h) x 680(d) x 1200(w) mm 1870(h) x 680(d) x 1200(w) mm with raised cell
<b>Weight:</b>	330 kg approx. (including oil)

\* At an ambient temperature of +23 °C

## NEEDED ACCESSORIES

**B201 KIT** AMPT Consumables kit. Comprises:

- **B253-53** Gauge point (24 pieces)
- **B201-52** 5 Minute, two part epoxy 24 ml
- **S311-03** 100 mm Sealing Rings (Pack of 10)
- **B201-53** 100 mm Rubber membrane 0.3 mm thickness (Pack of 10)
- **B200-10** Latex membrane material cut in 100mm diameter discs (needed for AASHTO T378)
- **B200-04** 100 mm AMPT tension platens (2 **needed** pieces) for S-VECD test



**B200-04** 100 mm AMPT tension platens

## OPTIONAL ACCESSORIES

- B270-18** Membrane stretcher for asphalt specimen Ø 100 mm (optional)
- B200-09** Spacer to enable 130mm tall specimens to be tested in tension/compression (S-VECD test on small specimens)
- B200-13** AMPT silent air compressor
- B200-13X** AMPT silent air compressor 230V 60Hz



Asphalt specimen  
with on-specimen LVDTs and load cell

## RECOMMENDED ACCESSORIES

- B202** Gauge Point Fixing Jig
- B202-04** Spacer for 130 mm specimen height to be used with gauge point fixing jig B202
- B203** AMPT Dynamic Verification Device
- H009-01EN** PC complete with LCD monitor 22", keyboard, mouse, cables and installation of Testlab software



**B202** Gauge point fixing jig



**B203** AMPT Dynamic Verification Device

## TESTING KITS

**B204 KIT** Overlay kit according to ASTM WK26816. Comprises:

- **B204-01** Overlay jig
- **B204-02** Pair of Overlay Tester (OT) specimen plates
- **B204-03** OT specimen preparation jig according to ASTM WK26816

**B204-01 KIT** Overlay kit according to TEX-248-F. Comprises:

- **B204-01** Overlay jig
- **B204-02** Pair of overlay tester (OT) specimen plates
- **B204-13** OT specimen preparation jig according to TEX-248-F

**B207-01 KIT** AMPT Indirect Tensile (IDT) kit. Comprises:

- **B207-01** AMPT IDT Jig
- **B253-01** LVDT mounting Jig
- **B253-03** Gauge point template (150 mm specimen)
- **B290-04** AMPT Miniature LVDT (1 mm) (4 pieces)
- **B253-53** Gauge point (32 pieces)
- **B207-02** Cable gland (4 pieces)

**B254-02 KIT** AASHTO TP124 | ASTM D8044 SCB testing kit. Comprises:

- **B208** SCB frame
- **B254-10** Roller support
- **B254-02** Springs and roller



**B254-02 KIT** AASHTO TP124 | ASTM D8044 SCB testing kit



**B207-01 KIT** AMPT indirect tensile kit



**B204 KIT** Overlay kit according to ASTM WK26816

### CDAS - Control and Data Acquisition System

Pavetest's compact Control and Data Acquisition System (CDAS) delivers unparalleled performance, real time control and ultimate versatility in acquisition.

The AMPT has a stand-alone CDAS, which is common to all Pavetest systems.



**B205** CDAS 8 channels

**SMALL SPECIMENS ACCESSORIES | AMPT**

For dynamic modulus on 38 mm (diameter) x 110 mm (h) specimen:

- B200-05** Bottom loading platen for 38 x 110 mm ( $\emptyset$  x h) specimen
- B200-06** Top loading platen for 38 x 110 mm ( $\emptyset$  x h) specimen
- B202** Gauge Point Fixing Jig
- B202-02** Spacer for 110 mm specimen height to be used with gauge point fixing jig B202
- B202-03** 38 mm and 50 mm diameter specimen - extension for gauge point fixing jig plungers B202
- B253-53** Gauge point (32 pieces)
- B201-52** 5 Minute, two part epoxy 24 ml
- S311** Sealing ring  $\emptyset$  38 mm (10 pcs)
- S310** Rubber membrane  $\emptyset$  38 mm (10 pcs)
- B270-20** Membrane stretcher for asphalt specimen  $\emptyset$  38 mm

For S-VECD test on 38 mm (diameter) x 110 mm (h) specimen:

- B200-11** 38MM AMPT tension platen (2 pieces needed)
- B202** Gauge Point Fixing Jig
- B202-02** Spacer for 110 mm specimen height to be used with gauge point fixing jig B202
- B202-03** 38 mm and 50 mm diameter specimen - extension for gauge point fixing jig plungers B202

For dynamic modulus on 50 mm (diameter) x 135 mm (h) specimen:

- B200-07** Bottom loading platen for 50 x 135 mm ( $\emptyset$  x h) specimen
- B200-08** Top loading platen for 50 x 135 mm ( $\emptyset$  x h) specimen
- B202** Gauge Point Fixing Jig
- B202-01** Spacer for 135 mm specimen height to be used with gauge point fixing jig B202
- B202-03** 38 mm and 50 mm diameter specimen - extension for gauge point fixing jig plungers B202
- B253-53** Gauge point (32 pieces)
- B201-52** 5 Minute, two part epoxy 24 ml
- S311-01** Sealing ring  $\emptyset$  50 mm (10 pcs)
- S310-01** Rubber membrane  $\emptyset$  50 mm (10 pcs)
- B270-21** Membrane stretcher for asphalt specimen  $\emptyset$  50 mm

For S-VECD test on 50 mm (diameter) x 135 mm (h) specimen:

- B200-12** 50MM AMPT tension platen (2 pieces needed)
- B202** Gauge Point Fixing Jig
- B202-01** Spacer for 135 mm specimen height to be used with gauge point fixing jig B202
- B202-03** 38 mm and 50 mm diameter specimen - extension for gauge point fixing jig plungers B202



**B202** Gauge Point Fixing Jig + accessories for small specimens preparation



## B215 OVERLAY TESTER

The Pavetest Overlay Tester is a servo-pneumatic controlled testing machine utilizing digital control of a high performance servo valve to provide accurate loading wave shapes up to 60Hz, specifically designed to determine the susceptibility of asphalt mixtures to cracking according to Texas DOT test procedure Tex-248-F and proposed ASTM Standard WK 26816.

The machine applies cyclic loading to a specimen that is cut from a 150 mm diameter sample into the shape of a rounded end beam. The system comprises a load frame, with one fixed and one moving plate, temperature control system, Control and Data Acquisition System (CDAS) and optional silent air compressor. The specimen is glued to two plates and this assembly is placed in the machine for testing. This is intended to simulate the action of movement under an asphalt overlay to assess how failure might occur in the field due to factors such as thermal expansion / contraction and reflective cracking.

The Pavetest Overlay Tester is underpinned by Pavetest's leading edge CDAS digital controller, TestLab software and all the necessary accessories, hardware and software in perfect unison.

### MAIN FEATURES

- Compact, fully self contained, precision engineered unit.
- Thermoelectric (TE) Heating/Cooling - More reliable and environmentally friendly than mechanical refrigeration & heating elements.
- Optional silent, air compressor including membrane dryer.
- Built in verification (Dial gauge).
- Integral stand with wheels.

The machine includes:

- Load frame with one fixed and one moving plate
- 15 kN Servo-pneumatic actuator (10 mm stroke)
- 8 Channel Control and Data Acquisition System (CDAS) & TestLab software
- Load cell ( $\pm 15\text{kN}$ )
- 10 mm displacement transducer
- Thermoelectric Heating/Cooling system
- Temperature transducer  $-80\text{ }^{\circ}\text{C}$  to  $+80\text{ }^{\circ}\text{C}$

It requires pressurized air, minimum 7 bar (not included)



**B215** Overlay tester

## TECHNICAL SPECIFICATIONS

<b>Load Capacity:</b>	Up to 16 kN (Static)
<b>Actuator stroke:</b>	10 mm
<b>Temperature range:</b>	10 to 60 °C
<b>Noise Level:</b>	Less than 70 db at 2 m
<b>Power supply:</b>	110/230V 50-60Hz 1ph 750W (B215)
<b>Dimensions:</b>	980 (h) x 475 (d) x 1085 (w) mm
<b>Weight:</b>	150 kg approx.

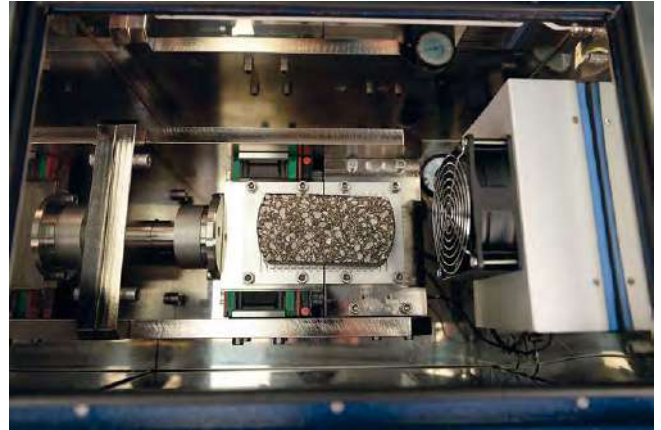

**B215** Overlay tester: detail

## TECHNICAL FEATURES

- **Temperature controller.** The overlay tester is fitted with a temperature controller, which controls the heating/cooling provided by the thermo-electric unit fitted to the machine.
- **The specimen preparation jig allows users to properly locate and glue the specimen on plates.** It can accommodate up to three sets of platens. It includes 2 mm teflon strip, which helps aligning the specimen plates and eliminate the need to saw the glue afterwards, and a dead weight.
- **The Overlay Tester main unit comes fully assembled.** It can be placed on the folding stand supplied, complete with wheels.

## NEEDED ACCESSORIES

**B204-02** Pair of specimen plates

**B204-03** OT specimen preparation jig according to ASTM WK 26816

**B204-13** OT specimen preparation jig according to Tex-248-F

**Note:** The quantity depends on the customer's need.

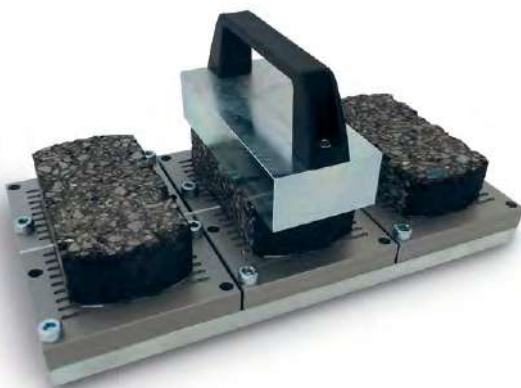

**B204-03** Specimen preparation jig



Detail of the wheels



**B204-02** Specimen plates

## OPTIONAL ACCESSORIES

**B204-11** Silent air compression 750W

**B204-11X** Silent air compression 750W 230V 60Hz

## TSRST-MULTI

### MULTI STATION THERMAL ASPHALT SYSTEM

#### STANDARDS:

**AASHTO TP10-1993** Standard test method for Thermal Stress Restrained Specimen Tensile strength

**EN 12697-46:2012** Test methods for hot mix asphalt Part 46: Low temperature cracking and properties by uniaxial tension tests

## FIRST STAND ALONE SERVO-HYDRAULIC TSRST

#### MAIN FEATURES

- Up to three working stations (electromechanical and/or servo-hydraulic stations).
- Servo-hydraulic actuator: 30 kN static, 25 kN dynamic, double acting, fatigue rated and equal area type with long life Labyrinth bearings & seals.
- Dynaflo™ Hydraulic Power Supply: Variable Frequency Drive 2.2 kW pump motor; Silent operation.
- Ability to clone, modify and/or generate user's own method file(s) to suit their specific requirements.
- Programmable test Wizard to guide the operator step by step based on a recipe book approach.
- Temperature controller programmed via PC software.



TSRST-MULTI STATION



## PAVETEST TSRST-MULTI: THE NEXT GENERATION OF MULTI-STATION THERMAL ASPHALT SYSTEM

The **Thermal Stress Restrained Specimen Test (TSRST)** is used to determine the low temperature cracking susceptibility of asphalt concrete. In the early 1990s the TSRST was developed by Oregon State University (OSU) as part of the Strategic Highway Research Program. The test method became AASHTO TP10.

# 1

### FIRST STAND-ALONE SERVO-HYDRAULIC TSRST ON THE MARKET

With up to three servo-hydraulic testing station in one unit, Pavetest TSRST-Multi is **the first stand-alone servo-hydraulic low temperature** cracking asphalt testing system **on the market** able to test up to three different specimens simultaneously, under the same temperature conditions.

### FLEXIBLE

Designed with flexibility in mind, **Pavetest** TSRST-multi can use different combinations of servo-hydraulic and/or electro-mechanical testing stations with **no need for a compressed air supply**.



### VERSATILE

Pavetest versatile TSRST-Multi can be used to evaluate:

- Uniaxial tension stress test (UTST)
- Thermal stress restrained specimen test (TSRST)
- Relaxation time, using the relaxation test (RT)
- Tensile creep tests (TCT)
- Uniaxial cyclic tension stress test (UCTST)
- Uniaxial thermal stress & strain test (UTSST) it requires additional hardware



### POWERFUL

Equipped with Pavetest's leading edge Control and Data Acquisition System (CDAS) and TestLab software, the user can control up to 3 testing stations in one unit, with unparalleled performance and ultimate versatility.





**EASY TO OPERATE**

Pavetest TestLab software makes it easy to operate the system because it enables the operator to program the temperature controller with ease.



**SAFE**

Pavetest TSRST-Multi employs a reliable refrigeration system, capable of cooling at a rate of 10° per hour. **Mechanical refrigeration eliminates the need for liquid nitrogen**, offering a completely safe working environment for the operator.



**QUIET**

The **Electro-mechanical and/or dynamically controlled hydraulic power supply are almost silent during testing.**



**DYNAFLO™**

The servo-hydraulic station(s) are powered by the Dynaflo Hydraulic Power Supply (HPS). The **Dynaflo HPS is an innovative concept based on “inverter” technology**: An inverter is used to control the speed of the pump motor to control hydraulic oil flow based on the requirements; **reducing noise and heat generation**, rendering the HPS silent in most applications. It also **improves the longevity of the pump** because it only works as hard as it needs making it quiet, cool and long lasting.

# THE DYNAFLO™ CONCEPT

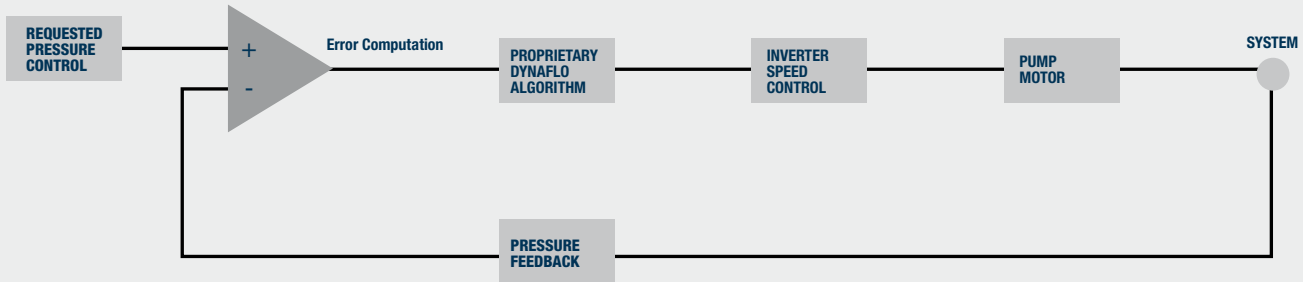

The **environmental chamber** is constructed from **top quality stainless steel**; stylish, durable and easy to clean.

**Mechanical refrigeration** capable of cooling at  $-10\text{ }^{\circ}\text{C}$  per hour down to  $-40\text{ }^{\circ}\text{C}$ ; no need for liquid nitrogen.

The **modular concept** allows the system to be configured in any combination of, **up to three electro-mechanical and/or servo-hydraulic stations**, without the need for compressed air supply.

The **high performance digital temperature controller** can be programmed through the software; eliminating the arduous task of setting the controller using the tiny buttons on the controller.

**Triple glazed, low-e glass door offers** excellent insulation without compromising visibility.

**Internal lighting** ensures good visibility under all conditions.

Uniquely **low coefficient of thermal expansion invar rods** offer accurate measurement and control over the full temperature spectrum.

**Axial alignment** is achieved using self-aligning couplings.

**Small footprint** makes best use of precious laboratory space.

**Only** requires **electrical power** for easy installation.

**Fully integrated digital control and data acquisition system (CDAS).**



## CONTROL AND DATA ACQUISITION SYSTEM (CDAS)



**B206** 16 CHANNEL CDAS

### CONTROL:

- High speed, (18 bit) digital servo-control, 4/6 axis.
- Digital closed loop update sampling rate of 2.5 kHz.
- Computer programmable, Proportional, Integral and Derivative (PID) control algorithm.
- Adaptive Level Control (ALC) algorithm for best dynamic peak accuracy.
- 3 feedback control modes. E.g. force, position and on-specimen strain.
- “Bumpless transfer” between control modes.

### ACQUISITION:

- Analog inputs are automatically calibrated on power up.
- Simultaneous sampling of all channels.
- 16 Analog ( $\pm 10$  Volt) input channels.
- Up to 64 times over sampling (set to 8 by default).
- 20 bit digital resolution (no auto ranging required).
- Sampling rate up to 192,000 samples/see.

### COMMUNICATION:

- USB or Ethernet

### ENVIRONMENTAL CHAMBER

- REFRIGERATION RANGE: -40 °C to + 40 °C, capable of cooling at a rate of 10 °C per hour.
- Optional: -50 °C to + 40 °C version.

**Real Time Dashboard** display shows transducer levels, computed data and charted data before, during and after the test has completed.

Dynamic image update feature shows visual image representation of specimen failure Multi- axes representation for clear visual presentation of test status for each axes.

Very user friendly presentation simplifies specimen setup in the machine.

The dashboard display feature of Testlab provides the user with an intuitive visual representation of the current status of both the machine and test method. The dashboard shows live transducer level measurements along with nominated key test data information and real time chart updates. This feature is individually customisable for each method file. Pavetest has already available dashboard designs for the more sophisticated tests including multi station TSRST.

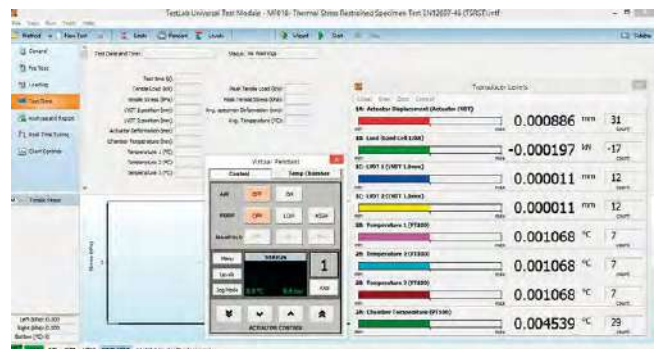

TestLab Universal Test Module

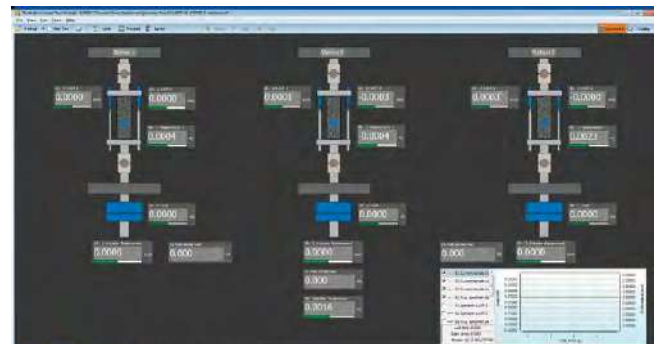

TSRST-Multi Dashboard

## TECHNICAL SPECIFICATIONS

### External dimensions load frame (including environmental chamber):

1853(h) x 1020(d) x 1230(w) mm

### Hydraulic Power Supply (for Servo-hydraulic station(s)):

700(h) x 520(d) x 570(w) mm

**Weight load frame:** 200 kg approx. without the selected stations configuration

### Electrical requirement for:

**Servo-hydraulic station (each):** 230V 50-60Hz 1ph 2.2kW

**Electro-mechanical station (each):**

100-230V 50-60Hz 1ph 0.75kW

**Refrigeration unit:** 380-420V 50Hz 3ph 2.5kW

**Loading frame(s)**

- Rigid two column frame
- Width of work space: 240 mm
- Height of work space (between the two platens): 285 mm

**Electro-mechanical actuator(s)**

- 25kN static with  $\pm 50$  mm stroke (100 mm)
- Internal displacement transducer

**Servo-hydraulic actuator**

- 30kN static, 25kN dynamic, double acting, fatigue rated, servo hydraulic actuator, equal area type with long life seals & bearings
- $\pm 50$  mm stroke (100 mm)
- Internal displacement transducer
- Close coupling of servo valve to actuator for best servo performance
- 10  $\mu$ m pressure line filter at actuator for ultimate contamination control
- 0.5 lt hydraulic accumulator with 40 Bar pre-charge for best pressure line regulation at servo-valve.
- High response, VCD direct drive, servo-valve: -3 db @ 350 Hz,  $\pm 5\%$  amplitude (performance curves available on request)

**Load cell(s)**

- Low profile Precision Transducers load cell,  $\pm 30$ kN, 0.1%. Normalized output with in-line signal conditioning

**Hydraulic power supply**

- Working pressure of up to 160 Bar (low pressure adjustable)
- High/Low pressure selectable from control pendant
- Variable flow rate up to 7.5 liter/min
- Variable Frequency Drive (VFD) 2.2kW pump motor; speed based on demand
- 3  $\mu$ m return line filtration
- Low oil, over temperature and dirty filter displayed
- Remote starting
- Pressure gauge
- Air cooling (Electric fan)

**B282-08** TSRST specimen gluing jig (needed accessory)

Simple and easy to use gluing jig for preparing TSRST specimens. The jig provides for perfect alignment and adjustment for different sized specimens. The clamping force is easily set and ensures the end plates are glued perpendicular to the specimen.

**ORDERING INFORMATION**

The basic MULTI TSRST includes the main frame, the CDAS, the climatic chamber, the refrigeration unit and at least one between the electro-mechanical or servo-hydraulic station. All available configurations are summarized in the following table:

	ELECTROMECHANICAL STATION	SERVO-HYDRAULIC STATION
<b>B282-10</b>	1	-
<b>B282-11</b>	2	-
<b>B282-12</b>	3	-
<b>B282-13</b>	-	1
<b>B282-14</b>	1	1
<b>B282-15</b>	2	1

**Note:**

Multiple stations configuration (B282-11, B282-12, B282-14, B282-15) allow to run tsrst tests with all stations simultaneously. In this configurations, utst, rt, tct, utsst and utcst tests are performed on one station at a time. With combined configuration (electromechanical and servo-hydraulic) utcst must be performed with servo-hydraulic station.

**TO PERFORM**

- Uniaxial tension stress test (UTST)
- Thermal stress restrained specimen test (TSRST)
- Relaxation time, using the relaxation test (RT)
- Tensile creep tests (TCT)
- Uniaxial cyclic tension stress tests (UCTST)\*\*
- Uniaxial thermal stress & strain test (UTSST)\*\*\*

\*\* Only applicable to servo-hydraulic work station(s)

\*\*\* Additional hardware required

**ACCESSORIES**

- B282-08** TSRST specimen gluing jig (**needed**)
- B282-18** TSRST proof test assembly (optional)

Disk Shaped Compact Tension test:

**B284-01** Disk-shaped compact tension test jig

**B282-02** Rod ends (2 pieces **needed**)

**B290-07** SCB deformation gauge (**needed**)

or

**B290-12** Epsilon (model 3541) clip-on gauge cmod transducer +1/-7 mm (Alternative to B290-07)

**C090-18** Knife edge (pack of 24) only for B290-12



## B225 STS-25 STATIC TESTING SYSTEM

THE MOST VERSATILE TESTING MACHINE IN THE MARKET

STANDARDS: ASTM D7313-07a | AASHTO TP105-13 | AASHTO TP124 | ASTM D8044 | ASTM WK 26816 | AASHTO T 314-12  
AASHTO TP10-1993 | TxDOT\_Tex-248-F

The Pavetest 25kN Static Testing System (STS-25) is an electro-mechanical servo-controlled testing machine utilizing digital control of a high performance electro-mechanical actuator to provide accurate loading rates up to 50mm/minute, designed to perform a range of static tests; including: Overlay, SCB, DCT, TSRST and DTT

The STS-25 is underpinned by Pavetest's leading edge CDAS digital controller, TestLab software and a full complement of accessories hardware and software in perfect unison.



### MAIN FEATURES

- Compact, fully self-contained, precision engineered unit.
- Precision electro-mechanical actuator (silent operation).
- Suitable for a range of testing protocols.
- A range of two piece climatic chambers.
- Operator can monitor, set and "Auto tune" the temperature controller via the PC.
- Optional swivel stand allows the unit to be oriented vertically or horizontally.

The machine includes:

- Rigid two column load frame
- 25 kN electro-mechanical actuator (30 mm stroke)
- 8 channel Control and Data Acquisition System (CDAS) & TestLab software
- Load cell ( $\pm 30$  kN)
- 30 mm actuator LVDT



**B225** STS-25 Static Testing System



Horizontal configuration complete  
with swivel stand B225-04

## TECHNICAL FEATURES

- **Electro-mechanical unit.** The machine applies constant rate of loading to a specimen that is placed in the load frame.
- **The system comprises** a load frame, with a load cell, integral displacement transducer, insulate cabinet, Control and Data Acquisition System (CDAS). The insulated chamber with small glass door reduces heat loss whilst providing uninterrupted view of the specimen.
- **Versatile.** An optional swivel stand allows the unit to be oriented vertically or horizontally; to suit the application.
- **Portable temperature control unit.** We offer three models of temperature control unit, with different temperature ranges, to cover a number of international testing standards.

## NEEDED ACCESSORIES

- B225-01** Temperature controlled cabinet - TE UNIT.  
+10 °C to +60 °C TO SUIT STS-25
- or
- B225-02H** Temperature controlled cabinet - REFR. UNIT.  
Horizontal configuration: -20 °C to +80 °C to suit STS-25
- or
- B225-03H** Temperature controlled cabinet - REFR. UNIT.  
Horizontal configuration: -40 °C to +80 °C to suit STS-25
- or
- B225-02V** Temperature controlled cabinet - REFR. UNIT.  
Vertical configuration: -20 °C to +80 °C to suit STS-25
- or
- B225-03V** Temperature controlled cabinet - REFR. UNIT.  
Vertical configuration: -40 °C to +80 °C to suit STS-25

## TECHNICAL SPECIFICATIONS

Load Capacity:	Up to 25kN
Actuator stroke:	30 mm
Testing space:	400 mm
Loading rate:	0.3mm/min. to 50mm/min.
Temperature range:	10 to 60 °C (thermoelectric unit) -20 to 80 °C or -40 to 80 °C (refrigeration unit)
Mains Power:	230V 50-60Hz 1ph (B225) 230V 50-60Hz 1ph (thermoelectric unit) 230V 50Hz 1ph (refrigeration unit)



Temperature  
controlled unit- REFR. UNIT



Temperature controlled cabinet - TE UNIT

## OPTIONAL ACCESSORIES

- H009-01EN** PC 22" with lcd screen
- B250-07-KIT** Temperature measuring KIT
- B225-04** swivel stand (only for B225-01)

For test configuration and related jigs, please consult p. 182-192

## B215EM ELECTRO-MECHANICAL OVERLAY TESTER

STANDARDS: ASTM WK 26816 Standard Test Method for Determining the Susceptibility of Asphalt Mixtures to Cracking Using the Overlay Tester  
TxDOT Tex-2 48-F –Test Procedure for Overlay Test

The Pavetest Overlay Tester is an electro-mechanical servo-controlled testing machine utilizing digital control of a high performance electro-mechanical actuator to provide accurate loading rates up to 50 mm/minute, designed to determine the susceptibility of Asphalt Mixtures to cracking. Applies tension in a **cyclic triangular waveform** to a constant maximum displacement of 0.6 mm (0.026). The sliding block reaches the maximum displacement and then returns to its initial position in 10 sec. (one cycle). The unit is underpinned by Pavetest's leading edge CDAS digital controller, TestLab software and a full complement of accessories hardware and software in perfect unison.



Horizontal configuration

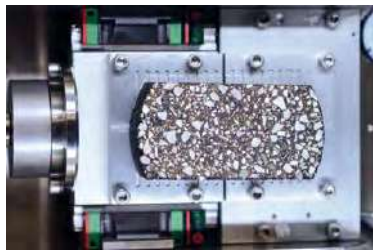

**B215EM** Electro-Mechanical Overlay Tester



**B204-03** Specimen preparation jig

### NEEDED ACCESSORIES

- B225-01** Temperature controlled cabinet - te unit:  
+10 °C to +60 °C
- or
- B225-02H** Temperature controlled cabinet - refr. unit.  
Horizontal configuration: -20 °C to +80 °C
- B204-14** Overlay jig
- B290-02** OT LVTD (10 MM) to be used with Electro-mechanical  
Overlay Tester
- B204-02** Pair of Overlay Tester (OT) specimen plates
- B204-03** OT Specimen preparation jig according to ASTM 26816
- or
- B204-13** OT Specimen preparation jig according to  
TxDOT\_tex-248-F



**B204-02** Specimen plates

### OPTIONAL ACCESSORY

- H009-01EN** PC 22" with lcd screen

## B225-09 DTT DIRECT TENSION TESTER

STANDARDS: AAHSTO T 314-12 Determining the Fracture Properties of Asphalt Binder in Direct Tension

The Pavetest DTT Direct Tension Tester is an electro-mechanical servo-controlled testing machine utilizing digital control of a high performance electro-mechanical actuator to provide accurate loading rates up to 50 mm/minute, designed to determine the fracture properties of Asphalt binder in Direct Tension (DTT). The unit is underpinned by Pavetest's leading edge CDAS digital controller, TestLab software and a full complement of accessories hardware and software in perfect unison.



B225-09 DTT Direct Tension Tester



Horizontal configuration



B225-10

### NEEDED ACCESSORIES

**B225-03H** Temperature controlled cabinet - refr. unit.  
Horizontal configuration: -40 °C to +80 °C

**B225-10** Direct Tension jig complete with 25 mm on specimen displacement transducer.



Temperature controlled unit- REFR. UNIT

### OPTIONAL ACCESSORY

**H009-01EN** PC 22" with lcd screen

## STS-25 - Ordering info

Sigla	Testing Kit/Jig/Accessories	Relevant standard(s)	With temperature controlled cabinet	Accessories
DC(T)	B284-01	ASTM D7313-07a	"(10°C greater than the low temperature PG of the asphalt binder) B225-02H or B225-02V or B225-03H or B225-03V	B290-07 needed or B290-12 + C090-18 needed
SCB	B254-02-KIT (B208+B254-10+B254-02)	AASHTO TP124 ASTM D8044	(25°C) B225-01+ optional B225-04 or B225-02V or B225-03V	B254-16 needed B290-02 (1or 2) optional B254-11 (according to B290-02 q.ty) optional B254-12 optional
SCB	B254-02-KIT (B208+B254-10+B254-02)	AASHTO TP105-13	(22°C greater than the low temperature PG of the asphalt binder) B225-02V or B225-03V	B254-16 needed 2 x B253-53 needed B254-13 needed 2 x B254-14 needed 2 x B254-15 needed 2 x B290-05 or 2 x B290-06 needed B290-07 or B290-16 + C090-18 needed
OT	B204-14	ASTM WK26816	(25°C) B225-01+ optional B225-04 or B225-02H or B225-03H	3 x B204-02 needed B204-03 needed B290-02OT needed
OT	B204-14	Tex 248F	(25°C) B225-01+ optional B225-04 or B225-02H or B225-03H	3 x B204-02 needed B204-13 needed B290-02OT needed
DTT	B225-10	AASHTO T314-12	(+6° to -40 °C) B225-03H	none
TSRST	B282-01-KIT (3 x B282-01+2 x B282-02 +1 x B282-21+1 x B282-09 +2 x B282-04+2 x B282-05 +2 x B282-06+B282-07)	AASHTO TP10	(-50°C to +10°C, capable of cooling at a rate of 10°C per hour) B225-03V	2 x B290-09 needed B282-08 needed B201-52 optional

# OUR CLIENTS ARE OUR BEST ADVERTISEMENT.





**MATEST**

**MATEST**

MIN  
MAX

# SECTION C

## CONCRETE



The accurate and satisfactory test of fresh and hardened concrete are essential elements for any type of building construction. The final quality of the concrete utilized in the structure depends on many variables like: workability, consistency, setting time, volumetric mass, air content, compressive strength, temperature, linear variations, etc.

Matest offers a complete range of testing and research equipment on concrete to satisfy all the above quality variables, in compliance with the EN, ASTM and most popular International Standards. In the second part of this section a complete range of instruments are available for non-destructive tests, to investigate and evaluate the progressive ageing and durability of concrete structures exposed to chemical attacks, air pollution, and time.





## COMPRESSION AND FLEXURAL TESTING MACHINES

Matest has the widest and most complete range of compression and flexural testing machines today available on the global market, making Matest leading manufacturer of testing machines.

The versatility and flexibility of Matest testing machines allow the end-user to select and combine compression/flexural groups in order to meet custom requirements.

The next pages describe:

- 1) General features of the compression frames with different control and measuring systems (p. 217-218)
- 2) Compression testing machines, four columns prestressed frame, conforming to Standards:  
ASTM C39 | BS 1610 | AASHTO T22 | NF P18-411 (p. 230...259)
- 3) Compression testing machines, four columns **tested for high stability frame**, conforming to Standards:  
EN 12390-4 | and BS 1881 | DIN 51220 and the determination of the automatic secant compression **elastic modulus** on concrete with pace rate control also when releasing the load, conforming to Standards:  
ASTM C469 | ISO 6784 | UNI 6556 | DIN 1048 (p. 261...281)
- 4) Flexural testing machines, conforming to Standards:  
EN 12390-5, EN 1340:4 | ASTM C78, C293 | BS 1881:118  
AASHTO T97 (p. 288...309)
- 5) Combined Groups for Compression, Flexural, Splitting, Block tests; cement compression/flexural frames, suitable to personalize and satisfy any specific requirement (p. 310)



## COMPRESSION TESTING MACHINES

It is technically well-known that the welded frames may have structural unexpected values and problems, while the four columns configuration guarantees tensional uniformity at all load levels.

Matest manufactures **compression machines four columns frame only**, and supplies two basic frame designs:

### ■ MACHINES WITH FOUR COLUMNS PRESTRESSED FRAME

STANDARDS: ASTM C39 | BS 1610 | NF P18-411

AASHTO T22

Models described at p. 230...259

### ■ MACHINES WITH FOUR COLUMNS TESTED FOR HIGH STABILITY FRAME

STANDARDS: EN 12390-4 | BS 1881 | DIN 51220

Models described at p. 261...281



### MAIN FEATURES

- Extremely strong and oversized load frame ensuring high rigidity and stability.
- Precision lapped upper ball-seat with compression platen.
- Compression platens are ground finish and surface hardened over 55 HRC.
- Designed to meet International Specifications: EN, ASTM, AASHTO, BS, NF, DIN.
- Available with 1300kN, 1500kN, 2000kN, 3000kN, 4000kN, 5000kN capacity to test cubes, cylinders and blocks.
- Both hand-operated and motorized versions with one or two gauges.
- Hydraulic device to stop the piston's stroke at its max excursion to avoid pumping the piston out of the cylinder.
- Available with automatic digital servo-controlled console and electronic digital display measuring system.
- Optional safety guards.

## HYDRAULIC SYSTEM

Piston has a large diameter: this allows the hydraulic circuit to work at low pressure with a longer life of the working components and higher precision in the results. Piston is ground and lapped, and a high quality packing set of three elements is used. Motorized models are equipped with a dial device to display, pre-select and control the flow allowing an uniform load rate as requested by the Standards. A fast approach ram action device avoids dead times during the stroke of the ram. Power pump is multipiston, assuring continuity of delivery, now with **improved performances and more silent**.

A movement indicator shows instant by instant the piston excursion during the compression test. A hopper covering the piston is conceived to avoid the powder of the broken specimen to enter into the cylinder of the press and damage the packing set.



➤ NEW

## LOAD MEASUREMENT SYSTEMS

### A) GAUGES

The gauges are Bourdon tube type. They include max. load pointer, zero adjustment and mirror face to avoid parallax errors. Low pressure gauge is fully protected from overload by a pressure control device.

**(A)**

### B) CYBER-PLUS Evolution, EIGHT analog channels system, for the acquisition, display and processing of test data, with software and printout of results and certificates.

Resolution up to 500.000 divisions.  
TOUCH-SCREEN COLOUR display, same as PC.  
Technical details: see mod. C109N, p. 222...228

**B) C109N**

### BB) DIGITEC, TWO analog channels system, for the acquisition, display and processing of test data with software (accessory) and printout of results and certificates.

Technical details: see mod: C108N, p. 219...221

**BB) C108N**

### C) SERVO-PLUS Evolution, automatic servo-controlled system, to provide fully automatic tests throughout all phases, with the support of the Cyber-Plus Evolution electronic technology.

Technical details: see mod: C104N, p. 222...228

**C) C104N**
**C104-04**

**C104-04**  **NEW**  
 CONSOLE, lined with sound-proofing material for noise reduction, new design.

### CC) AUTOTEC, automatic servo-controlled system, to provide fully automatic tests throughout all phases, with the support of the Digitec electronic technology

Technical details: see mod. C098N, p. 219...221

**CC) C098N**

## CALIBRATION AND PRECISION

All testing machines are calibrated with high accuracy electronic instruments and are guaranteed in CLASS "1" (max. error  $\leq$  than  $\pm 1\%$ ). Also starting from 1% of the full range.

A Calibration Certificate is supplied along with the machine.

## C108N DIGITEC | C098N AUTOTEC

Two-channels computerised graphic display system to control and manage all sorts of automatic (Autotec C098N) and semi-automatic (Digitec C108N) testing machines, for acquisition, display, processing, printing and saving test data and certificates, with software for remote control from PC.

SUITABLE TO UPGRADE OR COMPLETE YOUR CONCRETE OR MORTAR COMPRESSION AND FLEXURE TESTING MACHINES (also from other manufacturers).



### APPLICATIONS



Compression on concrete



Flexure on concrete



Splitting on concrete cubes and cylinders



Compression and Flexure on Mortars

**SPECIFICATIONS DIGITEC | AUTOTEC**

- **2 analogue-digital channels** accepting sensors, transducers or load cells at 2 mV/V, allows the connection to two different compression/flexure frames.
- Simple and immediate parameters set up and test execution, menu driven interface.
- Rapid approaching, touching on and breaking of the specimen under direct pump control (Autotec C098N)
- Automatic control of the pace rate (Autotec C098N)
- Continue load display.
- Breaking load detection.
- Automatic elaboration of the specific resistance value.
- Permanent file up to 1000 tests and file of 100 different types of specimens.
- Graphic display with high resolution: 192x64 pixels.
- Selectable measuring force: kN, lb
- Languages: English, French, German, Spanish, Italian, Polish, Czech, Turkish.
- **Class 1** starting from 10% of maximum value, on request from 1% of maximum value.
- **± 0.5% load accuracy.**

**Menu**

The display shows date and time, currently applied load and single load, latest effected tests, pace rate control, rapid commands functions, configuration in use, analogue channel and activated alarm.

**TECHNICAL STRUCTURE**

- Acquisition and data processing system at 24 bit, effective resolution: 17 bit.
- Operator interface composed by 5 multi-functions pushbuttons; function icons shown on the display.
- Different programmable safety devices for the machine or the specimen as the possibility to introduce a percentage of the maximum value reached during the text execution, thermal protection of the motor and different other settable alarms.
- The firmware contains a memory of the most used specimens: area, weight, specific weight.
- Possibility of personalization for special sized samples.
- RS232 interface: it allows the data transfer during the test or the test results directly to PC (via Microsoft Hyperterminal) or the remote control of the system by means of the UTM2 software (accessory).



Test setup



Test execution with pace rate controller



Max load alarm setting

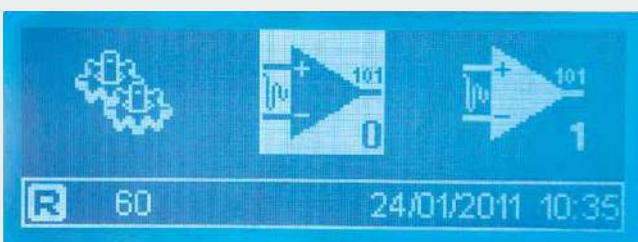

Channel configuration/calibration



Functions icons (test selection, file, alarms visualisation)

## MODELS

### C108N DIGITEC

Two channels unit for data acquisition and elaboration, as described.

**Power supply:** 230V 1ph 50-60Hz

**Dimensions:** 260x250x210 mm

**Weight:** 4 kg



C108N

### C098N AUTOTEC

Two channels servo controlled system for a fully automatic execution of the test.

The system comprises:

- Digitec C108N data acquisition unit
- Multi-piston electric pump with variable flow (see mod. C114) driven by a microprocessor (reliable and noiseless system, also for intensive and extended use)

**Power supply:** 230V 1ph 50Hz

**Dimensions:** 420x290x950 mm

**Weight:** 60 kg approx.



C098N

### C098-01N AUTOTEC FOR TWO FRAMES

Two channels servo controlled system, complete with three way hydraulic valve for the optional to connection of two testing frames.



C098-01N

## ACCESSORIES

**C127N** On board graphic printer on thermo-paper

**C127-11** Spare roll of thermo-paper for printer

## SOFTWARE

For the remote execution of the test and the automatic transfers and filing of the results on a computer

**C109-10** Software for COMPRESSION test on Concrete

**C109-11** Software for FLEXURAL test on Concrete

**C109-12** Software for SPLITTING TEST on Concrete specimens

**E163** Software for COMPRESSION test on Mortars

**E164** Software for FLEXURAL test on Mortars

**C123** Software "Servonet" for all the tests listed above. Suitable to be used only with the Autotec system.

### H009-01 EN PERSONAL COMPUTER

Complete with LCD, monitor 22", keyboard, mouse, connection cables. The supply of the PC includes the installation of the purchased software.



H009-01 EN

### PRESSURE TRANSDUCER

Used with both Digitec and Autotec, supplied along with proper connection cable and relative calibration certificate.

Available models: see p. 318



C116-09N

## ULTIMATE DESIGN, TIME-PROVEN SYSTEM, TRUSTY PERFORMANCES

### CYBER-PLUS EVOLUTION **NEW**

#### SEMI-AUTOMATIC APPLICATIONS

- Compression & flexural tests on concrete
- Compression & flexural tests on mortar
- Tensile, compression and bending tests on steel
- Splitting tensile tests on concrete cubes and cylinders



### ADVANCED SERVO-PLUS EVOLUTION **NEW**

#### SOPHISTICATED AND RESEARCH APPLICATIONS

#### In addition Advanced Servo-Plus Evolution can perform:

- Elastic modulus on rocks, concrete and mortar
- Triaxial tests on rock specimens



### SERVO-PLUS EVOLUTION **NEW**

#### FULLY AUTOMATIC APPLICATIONS

- Strain, ductility and post-breaking behaviour
- Deflection on fiber reinforced concrete beams
- Punching test on sprayed concrete specimens with energy absorption measurement



### SERVO-PLUS RESEARCH **NEW**

#### HIGH PERFORMANCE SERVO-PLUS SERVO-STRAIN

Performing tests in load, displacement and strain rate control:

- Compression, flexure and splitting tensile
- Elastic modulus and fiber reinforced concrete and shotcrete
- Triaxial test on rocks and Stress-path test procedure
- Suitable also for dynamic tests, at low frequencies up to 0.1 Hz



## C099N INVERTER DEVICE

- **Improved motor efficiency** with important reduction of absorbed power and electric consumption.
- **Reduction of noise pollution** thanks to a balanced and efficient delivery of the flow rate.
- **Improved piston speed** for a faster approach to reach the specimen with the result of having a considerable reduction in the overall test time.
- Improved reliability and life of the hydraulic pump thanks to a **decreased heating and mechanical stress**.
- **Better sensitivity** of load, deformation and speed adjustment.
- Accepts both 50Hz and 60Hz supply.



**C099N** inverter

## CONSOLE

### SILENT.STYLISH.STANDOUT.

- New console **with pumping unit lined with sound proofing material** in order to reduce noise.
- The design allows for the inverter integration.
- **The semi-automatic version (C104-06) grants an automatic speed selection by eliminating the manual pace-rate adjustment at minimum.**
- The only manual intervention required by the operator is the opening and closing of the dump valve for the hydraulic circuit.



**C109N** Cyber-plus +  
**C104-06** console +  
**C099N** inverter +  
**C114** pumping unit

#### **Note:**

The Inverter device may be mounted only on those machines equipped with **Servo-Plus** or **Servo-Plus Evolution** systems. With the Inverter device it is necessary to include also the Console C104-04 (fully automatic) or the Console C104-06 (semi-automatic).

## C099-01 BARCODE SCANNER



This instrument allows specimen file and identification by barcodes reading.

It can be connected cyber-plus / servo-plus control panels by USB, to automatically register specimen code and add it as a description of the test for all tests done with compression and flexure machines. Supplied complete with USB cable.



### TECHNICAL SPECIFICATIONS

- Codification capacity: UPC/EAN, UPC/EAN with supplements, Code 128, UCC/EAN 128, Code 39, Code 39 Full ASCII, Code 128 Full ASCII, Codabar, Interleaved 2 of 5, Code 93, MSI, Code 11, ISBN, ISSN, usw, etc...;
- Reader type: bidirectional;
- Light: 650 nm wavelength, laser-diode;
- Resolution: 0.10 mm;
- Reading distance: 3...400 mm;
- Reading angle: inclination angle 45°, elevation angle 60°;

**Dimensions:** 81x97x165 mm

**Weight:** 136 g



## C109N CYBER-PLUS | C104N SERVO-PLUS



**An electronic evolution with 8 analog inputs for compression and flexural testing machines on concrete and mortar.**

Designed with the latest technology, an innovative PC-like Touch Screen system, employed to control and manage all sorts of automatic (Servo-Plus Evolution C104N) and semi-automatic (Cyber-Plus Evolution C109N) testing machines.

To update or complete your compression and flexural testing machine on concrete and mortar (also on Non-Matest brands)



### APPLICATIONS



Compression on  
concrete



Flexure on concrete



Splitting on concrete  
cubes and cylinders



Compression and Flexure on Mortars



Tensile on  
steel

## MAIN FEATURES

- The control unit Cyber/Servo-Plus Evolution runs like a standard PC based on Windows operating system.
- The touch-screen graphical user-friendly interface allows an easy set up of the parameters and an immediate execution of the test.
- High resolution color display, ¼ VGA, offers all the functions of a PC for the management and analysis of data, test results, and graphs.

## ITOUCH TECHNOLOGY



### ONE TECHNOLOGY, MANY SOLUTIONS

IT TECH is Matest brand-new concept which aims to offer innovative and user-friendly technology to control and manage the most advanced material testing machines for the construction industry. This technology is the core feature of Matest control unit, a PC-based and touch screen system which is modular, flexible and multi-functions.

- IT TECH stands for:
- INNOVATION
  - ICON INTERFACE
  - INTERNET CONNECTION
  - INDUSTRIAL TECHNOLOGY

Graphic on board printer

Safety cut out switch

8 analog inputs for connecting load cells and transducers

2 USB-Host ports

SD card slot (unlimited memory)

C109N / C104N

1

2

3

## 3 OPERATING MODES

**1** Control from user friendly Touch-Screen display

**2** Large directional arrow-keys for gloved use

**3** Connection of a keyboard or mouse



Direct connection of the Cyber/Servo Plus Evolution to the Intranet (direct connection to a LAN network) and Internet to establish a remote communication and receive diagnostic analysis of potential problems, the ability to execute the test from distance and provide software updates. Matest technicians will check the unit located abroad to guarantee a prompt and professional assistance.

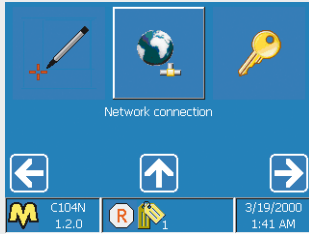

Internet direct connection for remote assistance

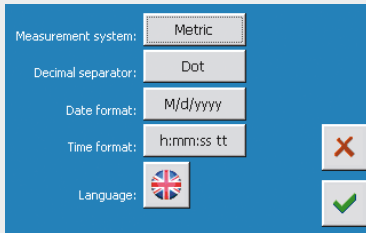

International settings and unlimited language selection



Easy and straightforward selection of the tests (compression)



Unlimited memory storage with: 2 USB-Host ports\* for PC, 1 SD card slot\* (\*memory hardware not included)

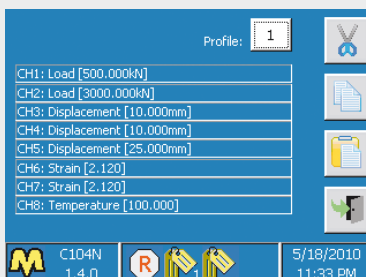

Endless number of test combinations and profile calibrations



Windows operating system like a standard PC. Touch-Screen color display, 1/4 VGA



Traditional directional key pad with 5 arrow-keys for standard use or when wearing gloves



Selection examples, Elastic Modulus

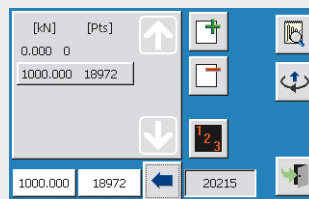

Calibration menu of a load channel. Easy set up of the calibration channel



On board graphic printer

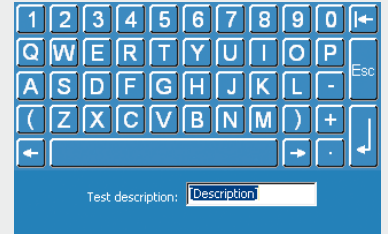

Qwerty Touch-Screen virtual alpha-numerical keyboard, user-friendly

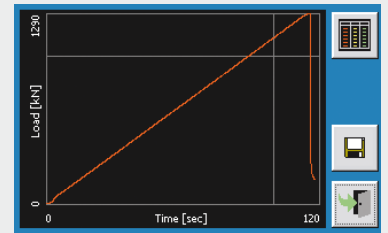

Compression Test. Visualization of the load/time graph in real time

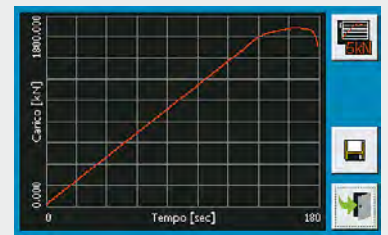

Automatic pace rate up to failure to avoid specimen's crumbling according to ASTM C39 Specification.

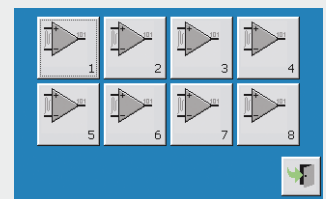

Simple and user-friendly functional channel configuration. 8 analog inputs for connecting up to 8 load cells or transducers



Laser printer for graphs and certificates with direct connection via USB.

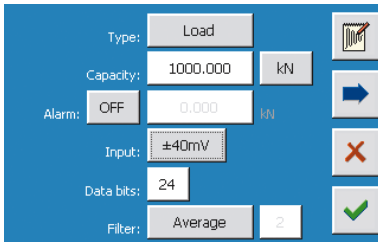

Configuration menu of a load channel.  
Rapid channel configuration



RS232 for PC connection only upon  
customer request LAN connection to internet

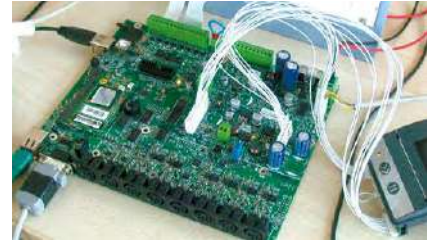

High technology and high  
performance hardware

## MAIN FUNCTIONS

- More intuitive interface which simplifies the use of the machine (test begins after a few simple inputs)
- Greater calculation ability and data display (on board charts and graphic print-outs)
- High management capacity for the multilingual framework and international settings (date and time, decimal units, unit of measure).
- Elastic software which allows the installation of new tests when desired.
- Profile configuration manager
- Configuration and calibration supervision of the analog channel
- Alarms manager
- Ethernet parameters configuration
- International settings configuration
- Hardware diagnosis functions
- Functions for the software updates and licenses
- Execution of tests through parameters set up customization
- Several levels of protection (passwords) to prevent the accessibility to the configuration menus by unauthorized staff.

**Cyber-Plus Evolution C109N** and **Servo-Plus Evolution C104N** are supplied complete with licenses for the execution of the following tests:

- COMPRESSION on Concrete
- FLEXURAL on Concrete
- SPLITTING TEST on cylinders and concrete cubes
- COMPRESSION on mortar
- FLEXURAL on mortar

In accordance to the following standards:  
EN, ASTM, BS, NF, DIN etc.

## MATEST CUSTOMER SERVICE



### C104-05 AFTER SALES TECHNICAL ASSISTANCE

Two hours of remote technical assistance, through a direct connection to the machine via internet. Customers are provided with diagnostics, any software updates or function restoring, all through a remote-access line, via mail, skype or phone, according to their needs.

**MODELS**
**C109N  
 CYBER-PLUS EVOLUTION**

8 channel unit for data acquisition and elaboration.

**Power Supply:** 230V 1F 50-60Hz 70W

**Dimensions:** 260x260x155 mm

**Weight:** 5 kg approx.

**C109N**
**C104-01N  
 SERVO-PLUS EVOLUTION FOR TWO FRAMES**

Servo controlled unit supplied with three way hydraulic valve for the option to connect and use up to TWO TESTING FRAMES.

**C104-02N  
 SERVO-PLUS EVOLUTION FOR THREE FRAMES**

Servo-controlled unit supplied with four way hydraulic valve for the option to connect and use up to THREE TESTING FRAMES.

**C127N**
**C104-01N**
**C104-04**
**C104N  
 SERVO-PLUS EVOLUTION**

8 channel servo controlled unit for a fully automatic execution of the test. The machine comprises:

- Cyber-Plus Evolution C109N data acquisition system
- Multi-piston electric pump with variable flow (see mod. C114) driven by a microprocessor (reliable and noiseless system, also for intensive and extended use)

**Power supply:** 230V 1ph 50Hz 750W

**Dimensions:** 420x290x1120 mm

**Weight:** 60 kg approx.

**C127N**
**C127N**
**C104N**
**C104N + C104-04**
**ACCESSORIES**
**C104-04**

CONSOLE HOUSING THE SERVO-PLUS EVOLUTION

The pump assembly **lined with sound-proofing material for noise reduction** and the digital system are encased to enhance the design and look of the machine.

**C104-09**

CONFIGURATION OF ADVANCED PARAMETERS THROUGH TESTS ON REAL SAMPLES

Valid for all MATEST testing machines equipped with SERVOPLUS/CYBERPLUS controlling unit.

When ordered, the setting of the advanced parameters becomes a phase of the production process. Through tests on real samples, it's possible to define in details the behavior of the tested material and therefore set into the SERVOPLUS/CYBERPLUS controlling units advanced parameters accordingly. For the setting of the advanced parameters, it's necessary to have some real samples available at MATEST's premises.

## COMPRESSION TESTING MACHINES, FOUR COLUMNS PRESTRESSED FRAME FOR PRODUCTION ROUTINE TESTS

These models are described at p. 230...259

STANDARDS: ASTM C39 | BS 1610 | NF P18-411 | AASHTO T22 | GOST 10180-2012

### MAIN FEATURES

- Compression platens are surface hardened over 55 HRC and rectified.
- Device to check piston's excursion during test.
- The columns are prestressed to provide a very high rigidity.
- Piston having 50 mm stroke and cylinder are coupled with high quality packing set.
- The tank has an oil level and oil discharge.
- Dial speed selector to display, pre-select and control oil flow.
- Multipiston power pump assuring continuity of delivery.
- Fast approach ram device to avoid dead times.
- Ball seating is accurately machined.

Available capacities:

1300 kN | 1500 kN | 2000 kN | 2000 kN BLOCKS | 3000 kN | 3000 kN BLOCKS | 5000 kN

Motorized or hand operated models.

Load measuring system: bourdon type gauges, **DIGITEC** or **CYBER-PLUS** graphic display units, **AUTOTEC** or **SERVO-PLUS EVOLUTION** servo-controlled automatic systems.



## COMPRESSION TESTING MACHINE 1300 KN CAPACITY

TO TEST CYLINDERS UP TO Ø 160X320 MM AND CUBES UP TO 150 MM SIDE

STANDARDS: ASTM C39 | AASHTO T22 | NF P18-411 | BS 1610 | GOST 10180-2012

### DIAL GAUGES MODELS

- Gauges Ø 250 mm with specific resistance scales for cubes 150 mm and cylinders Ø 150 - 160 mm
- Gauges divisions: 1300 kN div. 4 kN  
600 kN div. 2 kN

### MAIN FEATURES FOR ALL MODELS

- Max. vertical daylight: 336 mm
- Horizontal daylight between columns: 270 mm ▶ NEW
- Compression platens Ø 216 mm
- High stiffness and heavy weight 4 columns frame (german-style).
- Calibration accuracy: Class 1
- Max. ram travel 55 mm approx.
- Power supply (motorized models): 230V 1ph 50Hz 750W
- Dimensions: 900x730x280 mm approx.
- Weight: 580...620 kg



**C022**



**C025A + C127N + C111 + C121**

COMPRESSION 1300 kN capacity

LOAD MEASURING SYSTEM

MODEL	Hand Operated	Motorized	LOAD MEASURING SYSTEM			
			1 Gauge	2 Gauge	Digitec mod. C108N (p. 219)	Autotec mod. C098N (p. 219)
<b>C020</b>	▼		▼			
<b>C021</b>	▼			▼		
<b>C022</b>		▼	▼			
<b>C023</b>		▼		▼		
<b>C024D</b>		▼			▼	
<b>C025A *</b>		▼				▼

**COMPRESSION TESTING MACHINE HIGH-END MODELS**

TO TEST CYLINDERS UP TO Ø 160X320 MM AND CUBES UP TO 150 MM SIDE

STANDARDS: ASTM C39 | AASHTO T22 | NF P18-411 | BS 1610 | GOST 10180-2012



1300 KN CAPACITY

**CYBER-PLUS OR SERVO-PLUS EVOLUTION** DIGITAL TOUCH SCREEN DISPLAY

Cyber and Servo-Plus models have robust and reliable electronic controller, 5.7" touch screen color display. 2 USB ports, 1 SD port, 8 channels for pressure transducers (force measurement) or displacement transducers (Elastic Modulus and Poisson ratio measurement).

**INVERTER**

For a further improvement of energy efficiency and silent operation, (optional device code C099N).  
Technical details, p. 223

**NEW****BARCODE**

Scanner for specimen file/identification, (optional device code C099-01).  
Details, p. 223

**NEW****C024N****C025N + C127N + C111-01 + C121**

COMPRESSION 1300 kN capacity

LOAD MEASURING SYSTEM

MODEL	Motorized	Cyber-Plus Evolution mod. C109N (p.224)	Servo-Plus Evolution mod. C104N (p.224)
<b>C024N</b>	▼	▼	
<b>C025N *</b>	▼		▼

\* Servo-Plus/Autotec models feature fully automatic power pack - electrovalve operated test start (no manual lever).



**ACCESSORIES FOR 1300 kN MACHINES FROM MOD. C020 TO C025N**

- C111-30** DISTANCE PIECE, 20 mm high for cylinders  
 $\varnothing$  150x300 mm
- C111** DISTANCE PIECE, 176 high for cubes 150 mm side
- C111-01** DISTANCE PIECES, 176+50 mm high for cubes 150 and  
 100 mm side
- C111-03** DISTANCE PIECE, 100 high for cylinders  $\varnothing$  110x220 mm
- C111-03 + C111-30** DISTANCE PIECES, 100 + 20 mm high for  
 cylinders  $\varnothing$  100x200 mm
- C111-21** DISTANCE PIECE, 50 mm high

 **Note:** the cylinders  $\varnothing$  160x320 mm do not require any distance piece.

**C127N** GRAPHIC PRINTER on thermo-paper on board for digital models

**C127-11** THERMO-PAPER roll for printer (pack of 10 rolls)

**C121** SAFETY GUARDS, polycarbonate, with hinges and lock, to CE Directive. p. 317

**C121-51** STOP SWITCH on safety guard. See p. 317

**C041-11** TESTING CHAMBER with vertical clearance of 376 mm, complete with distance piece 40 mm high, that allows to test cylinders  $\varnothing$  150x300 mm and 160x320 mm with **capping retainers** (ASTM C1231 | AASHTO T22, T851)

**C107-10** CAPPING RETAINERS (set of two) for cylinders  
 $\varnothing$  150 mm and 6"

**C107-12** CAPPING RETAINERS (set of two) for cylinders  $\varnothing$  160 mm

**C107-20** NEOPRENE PADS (set of two) for cylinders  
 $\varnothing$  150 mm 60 shore A

**C107-21** NEOPRENE PADS (set of two) for cylinders  $\varnothing$  150 mm  
 70 shore A



**C107-10 + C107-20**

**C107-25** NEOPRENE PADS (set of two) for cylinders  $\varnothing$  160mm  
 60 shore A

**C107-26** NEOPRENE PADS (set of two) for cylinders  $\varnothing$  160 mm  
 70 shore A

 **Note:** The capping retainers can be used only with the testing chamber having vertical clearance of 376 mm, mod. C041-11  
 Technical details: see p. 316

**C115-01** TWO WAY HYDRAULIC VALVE, connected to the motorized pumping unit of the machine to activate a second frame. Technical details: see p. 318



**C115-01**

**C097-05** CALIBRATION CLASS 1, starting from 1% of the full range. With a special calibration procedure it is possible to grant Class 1 practically on the full range of the compression machine. Applicable only on digital machines.

**C097-01** DUAL LOW CAPACITY DIGITAL RANGE, complete with **appropriate pressure transducer**, only for digital machines. Recommended range 0-250kN.  
 Technical details: see p. 313



**C097-01**

**C107** AUTO-CENTERING DEVICE for cubes 100 and 150 mm side, and cylinders  $\varnothing$  100 and 150 mm.  
 Technical details: see p. 316



**C107**

- C100** SPLITTING TENSILE test device for cylinders.  
EN 12390-6 | ASTM C496  
Technical details and other models: see p. 314

**C100**

- C103** SPLITTING TENSILE test device for self blocking pavers and cubes. EN 1338, 12390-6.  
Technical details: see p. 314

**C103**

- C106** FLEXURAL TEST DEVICE for concrete beams.  
EN 12390-5 | ASTM C78, C293 | AASHTO T97  
Technical details: see p. 315

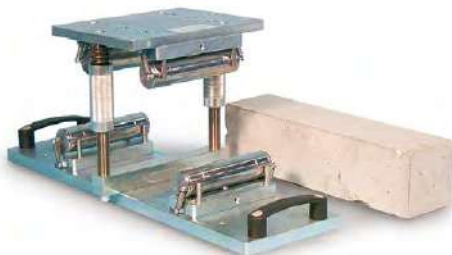
**C106**

- E170** COMPRESSION DEVICE to test cement specimens  
40.1x40 mm EN 196 | ASTM C349  
Technical details and other models: see p. 315

**E170**

- C126** BENCH to hold the compression machine. See p. 317

- C104-04** CONSOLE HOUSING THE SERVO-PLUS EVOLUTION  
The pump assembly "lined" with sound proofing material for noise reduction and the digital system are encased to enhance the design and look of the machine.  
Technical details: see p. 312

**C025N****C104-04**

- C099N** INVERTER DEVICE  
**NEW** Applicable only on Cyber-Plus and Servo-Plus Evolution machines.  
Technical details: see p. 223

**C104-06****C099N**

- C104-06** CONSOLE HOUSING THE CYBER-PLUS EVOLUTION  
**NEW** New console internally lined with sound proofing material, to reduce noise and allow for the inverter integration. Detail: see p. 223

#### SOFTWARE for DIGITEC / AUTOTEC or CYBER / SERVO PLUS models

<b>C109-10 (N)*</b>	SOFTWARE for compression tests
<b>C123 (N)*</b>	SOFTWARE <b>Servonet</b> for remote control through PC
<b>C109-11 (N)*</b>	SOFTWARE for flexural tests
<b>C109-12 (N)*</b>	SOFTWARE for splitting tensile

Technical detail: see p. 18

**(N)\*** for Cyber - Servo Plus models.

## COMPRESSION TESTING MACHINE 1500 KN CAPACITY

TO TEST CUBES UP TO 150 MM SIDE AND CYLINDERS UP TO Ø 160X320 MM

STANDARDS: ASTM C39 | AASHTO T22 | NF P18-411 | BS 1610 | GOST 10180-2012

### DIAL GAUGES MODELS

- Gauges Ø 250 mm with specific resistance scales for cubes 150 mm and cylinders Ø 150 - 160 mm
- Gauges divisions: 1500 kN div. 5 kN  
600 kN div. 2 kN



**C038 + C126**

### MAIN FEATURES FOR ALL MODELS

- Max. vertical daylight: 336 mm
- Horizontal daylight between columns: 270 mm ➤ NEW
- Compression platens Ø 216 mm
- High stiffness and heavy weight 4 columns frame (german-style).
- Calibration accuracy: Class 1
- Max. ram travel 55 mm approx.
- Power supply (motorized models): 230V 1ph 50Hz 750W
- Dimensions: 900x730x280 mm approx.
- Weight: 580...620 kg



**C040D + C127N + C111-01**

COMPRESSION 1500 kN capacity

LOAD MEASURING SYSTEM

MODEL			LOAD MEASURING SYSTEM			
	Hand Operated	Motorized	1 Gauge	2 Gauge	Digitec mod. C108N (p. 219)	Autotec mod. C098N (p. 219)
<b>C036</b>	▼		▼			
<b>C037</b>	▼			▼		
<b>C038</b>		▼	▼			
<b>C039</b>		▼		▼		
<b>C040D</b>		▼			▼	
<b>C041A *</b>		▼				▼

**COMPRESSION TESTING MACHINE HIGH-END MODELS**

TO TEST CUBES UP TO 150 MM SIDE AND CYLINDERS UP TO Ø 160X320 MM

STANDARDS: ASTM C39 | AASHTO T22 | NF P18-411 | BS 1610 | GOST 10180-2012



1500 KN CAPACITY

**CYBER-PLUS OR SERVO-PLUS EVOLUTION** DIGITAL TOUCH SCREEN DISPLAY

Cyber and Servo-Plus models have robust and reliable electronic controller, 5.7" touch screen color display. 2 USB ports, 1 SD port, 8 channels for pressure transducers (force measurement) or displacement transducers (Elastic Modulus and Poisson ratio measurement).

**INVERTER**

For a further improvement of energy efficiency and silent operation, (optional device code C099N).  
Technical details, p. 223

**BARCODE**

Scanner for specimen file/identification, (optional device code C099-01).  
Details, p. 223

**C040N****C041N + C127N + C104-04**

COMPRESSION 1500 kN capacity

LOAD MEASURIG SYSTEM

MODEL	Motorized	Cyber-Plus Evolution mod. C109N (p. 224)	Servo-Plus Evolution mod. C104N (p. 224)
<b>C040N</b>	▼	▼	
<b>C041N *</b>	▼		▼

\* Servo-Plus/Autotec models feature fully automatic power pack - electrovalve operated test start (no manual lever).

**ACCESSORIES FOR 1500 kN MACHINES FROM MOD. C036 TO C041N**

- C111-30** DISTANCE PIECE, 20 mm high for cylinders  
 Ø 150x300 mm
- C111** DISTANCE PIECE, 176 high for cubes 150 mm side
- C111-01** DISTANCE PIECES, 176+50 mm high for cubes 150 and  
 100 mm side
- C111-03** DISTANCE PIECE, 100 high for cylinders Ø 110x220 mm
- C111-03 + C111-30** DISTANCE PIECES, 100 + 20 mm high for  
 cylinders Ø 100x200 mm
- C111-21** DISTANCE PIECE, 50 mm high

 **Note:** the cylinders Ø 160x320 mm do not require any distance piece.

- C127N** GRAPHIC PRINTER on thermo-paper on board for digital models
- C127-11** THERMO-PAPER roll for printer (pack of 10 rolls)
- C121** SAFETY GUARDS, polycarbonate, with hinges and lock, to CE Directive. p. 317
- C121-51** STOP SWITCH on safety guard. See p. 317
- C041-11** TESTING CHAMBER with vertical clearance of 376 mm, complete with distance piece 40 mm high, that allows to test cylinders Ø 150x300 mm and 160x320 mm with **capping retainers** (ASTM C1231 | AASHTO T22, T851)
- C107-10** CAPPING RETAINERS (set of two) for cylinders Ø 150 mm and 6"
- C107-12** CAPPING RETAINERS (set of two) for cylinders Ø 160 mm
- C107-20** NEOPRENE PADS (set of two) for cylinders Ø 150 mm 60 shore A
- C107-21** NEOPRENE PADS (set of two) for cylinders Ø 150 mm 70 shore A

**C107-10 + C107-20**

- C107-25** NEOPRENE PADS (set of two) for cylinders Ø 160mm 60 shore A
- C107-26** NEOPRENE PADS (set of two) for cylinders Ø 160 mm 70 shore A

 **Note:** The capping retainers can be used only with the testing chamber having vertical clearance of 376 mm, mod. C041-11  
 Technical details: see p. 316

- C115-01** TWO WAY HYDRAULIC VALVE, connected to the motorized pumping unit of the machine to activate a second frame. Technical details: see p. 318

**C115-01**

- C097-05** CALIBRATION CLASS 1, starting from 1% of the full range. With a special calibration procedure it is possible to grant Class 1 practically on the full range of the compression machine. Applicable only on digital machines.

- C097-01** DUAL LOW CAPACITY DIGITAL RANGE, complete with **appropriate pressure transducer**, only for digital machines. Recommended range 0-250kN. Technical details: see p. 313

**C097-01**

- C107** AUTO-CENTERING DEVICE for cubes 100 and 150 mm side, and cylinders Ø 100 and 150 mm. Technical details: see p. 316

**C107**

- C100** SPLITTING TENSILE test device for cylinders.  
EN 12390-6 | ASTM C496  
Technical details and other models: see p. 314

**C100**

- C103** SPLITTING TENSILE test device for self blocking pavers and cubes. EN 1338, 12390-6.  
Technical details: see p. 314

**C103**

- C106** FLEXURAL TEST DEVICE for concrete beams.  
EN 12390-5 | ASTM C78, C293 | AASHTO T97  
Technical details: see p. 315

**C106**

- E170** COMPRESSION DEVICE to test cement specimens  
40.1x40 mm EN 196 | ASTM C349  
Technical details and other models: see p. 315

**E170**

- C126** BENCH to hold the compression machine. See p. 317

- C104-04** CONSOLE HOUSING THE SERVO-PLUS EVOLUTION  
The pump assembly **lined** with sound proofing material for noise reduction and the digital system are encased to enhance the design and look of the machine.  
Technical details: see p. 312

**C041N****C104-04**

- C099N** INVERTER DEVICE  
**NEW** Applicable only on Cyber-Plus and Servo-Plus Evolution machines.  
Technical details: see p. 223

**C104-06****C099N**

- C104-06** CONSOLE HOUSING THE CYBER-PLUS EVOLUTION  
**NEW** New console internally lined with sound proofing material, to reduce noise and allow for the inverter integration. Detail: see p. 223

#### SOFTWARE for DIGITEC / AUTOTEC or CYBER / SERVO PLUS models

<b>C109-10 (N)*</b>	SOFTWARE for compression tests
<b>C123 (N)*</b>	SOFTWARE <b>Servonet</b> for remote control through PC
<b>C109-11 (N)*</b>	SOFTWARE for flexural tests
<b>C109-12 (N)*</b>	SOFTWARE for splitting tensile

Technical detail: see p. 18

**(N)\*** for Cyber - Servo Plus models.

## COMPRESSION TESTING MACHINE 2000 KN CAPACITY

TO TEST CUBES UP TO 150 MM SIDE AND CYLINDERS UP TO Ø 160X320 MM

STANDARDS: ASTM C39 | AASHTO T22 | NF P18-411 | BS 1610 | GOST 10180-2012

### DIAL GAUGES MODELS

- Gauges Ø 250 mm with specific resistance scales for cubes 150 mm and cylinders Ø 150 - 160 mm
- Gauges divisions: 2000 kN div. 5 kN  
600 kN div. 2 kN

### MAIN FEATURES FOR ALL MODELS

- Max. vertical daylight: 336 mm
- Horizontal daylight between columns: 270 mm ➤ NEW
- Compression platens Ø 216 mm
- High stiffness and heavy weight 4 columns frame (german-style).
- Calibration accuracy: Class 1
- Max. ram travel 55 mm approx.
- Power supply: 230V 1ph 50Hz 750W
- Dimensions: 1000x780x300 mm approx.
- Weight: 670...720 kg



C055D + C111



C056A + C127N

COMPRESSION 2000 kN capacity

LOAD MEASURING SYSTEM

MODEL	Motorized	1 Gauge	2 Gauge	Digitec mod. C108N (p. 219)	Autotec mod. C098N (p. 219)
<b>C053</b>	▼	▼			
<b>C054</b>	▼		▼		
<b>C055D</b>	▼			▼	
<b>C056A *</b>	▼				▼

**COMPRESSION TESTING MACHINE HIGH-END MODELS**

TO TEST CUBES UP TO 150 MM SIDE AND CYLINDERS UP TO Ø 160X320 MM

STANDARDS: ASTM C39 | AASHTO T22 | NF P18-411 | BS 1610 | GOST 10180-2012



2000 KN CAPACITY

**CYBER-PLUS OR SERVO-PLUS EVOLUTION** DIGITAL TOUCH SCREEN DISPLAY

Cyber and Servo-Plus models have robust and reliable electronic controller, 5.7" touch screen color display. 2 USB ports, 1 SD port, 8 channels for pressure transducers (force measurement) or displacement transducers (Elastic Modulus and Poisson ratio measurement).

**INVERTER**

For a further improvement of energy efficiency and silent operation, (optional device code C099N).  
Technical details, p. 223

**BARCODE**

Scanner for specimen file/identification, (optional device code C099-01).  
Details, p. 223



C055N + C127N + C111



C056N + C127N + C111 + C104-04 + C121-05

COMPRESSION 2000 kN capacity

**LOAD MEASURING SYSTEM**

MODEL	Motorized	Cyber-Plus Evolution mod. C109N (p. 224)	Servo-Plus Evolution mod. C104N (p. 224)
<b>C055N</b>	▼	▼	
<b>C056N *</b>	▼		▼

\* Servo-Plus/Autotec models feature fully automatic power pack - electrovalve operated test start (no manual lever).



**ACCESSORIES FOR 2000 kN MACHINES FROM MOD. C053 TO C056N**

- C111-30** DISTANCE PIECE, 20 mm high for cylinders  
 $\varnothing$  150x300 mm
- C111** DISTANCE PIECE, 176 high for cubes 150 mm side
- C111-01** DISTANCE PIECES, 176+50 mm high for cubes 150 and  
 100 mm side
- C111-03** DISTANCE PIECE, 100 high for cylinders  $\varnothing$  110x220 mm
- C111-03 + C111-30** DISTANCE PIECES, 100 + 20 mm high for  
 cylinders  $\varnothing$  100x200 mm
- C111-21** DISTANCE PIECE, 50 mm high

 **Note:** the cylinders  $\varnothing$  160x320 mm do not require any distance piece.

- C127N** GRAPHIC PRINTER on thermo-paper on board for digital models
- C127-11** THERMO-PAPER roll for printer (pack of 10 rolls)
- C121-05** SAFETY GUARDS, polycarbonate, with hinges and lock, to CE Directive. p. 317
- C121-51** STOP SWITCH on safety guard. See p. 317
- C056-11** TESTING CHAMBER with vertical clearance of 376 mm, complete with distance piece 40 mm high, that allows to test cylinders  $\varnothing$  150x300 mm and 160x320 mm with **capping retainers** (ASTM C1231 | AASHTO T22, T851)
- C107-10** CAPPING RETAINERS (set of two) for cylinders  $\varnothing$  150 mm and 6"
- C107-12** CAPPING RETAINERS (set of two) for cylinders  $\varnothing$  160 mm
- C107-20** NEOPRENE PADS (set of two) for cylinders  $\varnothing$  150 mm 60 shore A
- C107-25** NEOPRENE PADS (set of two) for cylinders  $\varnothing$  160mm 60 shore A

 **Note:** The capping retainers can be used only with the testing chamber having vertical clearance of 376 mm, mod. C041-11  
 Technical details: see p. 316

**C107-10 + C107-20**

- C115-01** TWO WAY HYDRAULIC VALVE, connected to the motorized pumping unit of the machine to activate a second frame. Technical details: see p. 318

**C115-01**

- C097-05** CALIBRATION CLASS 1, starting from 1% of the full range. With a special calibration procedure it is possible to grant Class 1 practically on the full range of the compression machine. Applicable only on digital machines.

- C097-01** DUAL LOW CAPACITY DIGITAL RANGE, complete with **appropriate pressure transducer**, only for digital machines. Recommended range 0-250kN. Technical details: see p. 313

**C097-01**

- C107** AUTO-CENTERING DEVICE for cubes 100 and 150 mm side, and cylinders  $\varnothing$  100 and 150 mm. Technical details: see p. 316

**C107**

- C100** SPLITTING TENSILE test device for cylinders.  
EN 12390-6 | ASTM C496  
Technical details and other models: see p. 314

**C100**

- C103** SPLITTING TENSILE test device for self blocking pavers and cubes. EN 1338, 12390-6.  
Technical details: see p. 314

**C103**

- C106** FLEXURAL TEST DEVICE for concrete beams.  
EN 12390-5 | ASTM C78, C293 | AASHTO T97  
Technical details: see p. 315

**C106**

- E170** COMPRESSION DEVICE to test cement specimens  
40.1x40 mm EN 196 | ASTM C349  
Technical details and other models: see p. 315

**E170**

- C126** BENCH to hold the compression machine. See p. 317

- C104-04** CONSOLE HOUSING THE SERVO-PLUS EVOLUTION  
The pump assembly **lined** with sound proofing material for noise reduction and the digital system are encased to enhance the design and look of the machine.  
Technical details: see p. 312

**C056N****C104-04**

- C099N** INVERTER DEVICE  
**NEW** Applicable only on Cyber-Plus and Servo-Plus Evolution machines.  
Technical details: see p. 223

**C104-06****C099N**

- C104-06** CONSOLE HOUSING THE CYBER-PLUS EVOLUTION  
**NEW** New console internally lined with sound proofing material, to reduce noise and allow for the inverter integration. Detail: see p. 223

#### SOFTWARE for DIGITEC / AUTOTEC or CYBER / SERVO PLUS models

<b>C109-10 (N)*</b>	SOFTWARE for compression tests
<b>C123 (N)*</b>	SOFTWARE <b>Servonet</b> for remote control through PC
<b>C109-11 (N)*</b>	SOFTWARE for flexural tests
<b>C109-12 (N)*</b>	SOFTWARE for splitting tensile

Technical detail: see p. 18

**(N)\*** for Cyber - Servo Plus models.

## COMPRESSION TESTING MACHINE 2000 KN CAPACITY

TO TEST CUBES UP TO 200 MM SIDE AND CYLINDERS UP TO 280 MM HEIGHT

STANDARDS: ASTM C39 | AASHTO T22 | BS 1610 | GOST 10180-2012

### DIAL GAUGES MODELS

- Gauges Ø 250 mm with specific resistance scales for cubes 150 mm and cylinders Ø 150 - 160 mm
- Gauges divisions: 2000 kN div. 5 kN  
600 kN div. 2 kN

### MAIN FEATURES FOR ALL MODELS

- Max. vertical daylight: 282 mm
- Horizontal daylight between columns: 270 mm ➤ NEW
- Compression platens Ø 287 mm
- High stiffness and heavy weight 4 columns frame (german-style).
- Calibration accuracy: Class 1
- Max. ram travel 55 mm approx.
- Power supply: 230V 1ph 50Hz 750W
- Dimensions: 690x400x1320 mm approx.
- Weight: 670...720 kg



C058-04D + C127N + C111-22



C058-05A + C127N + C121-05 + C111-26 + C111-22

COMPRESSION 2000 kN capacity

LOAD MEASURING SYSTEM

MODEL	Motorized	1 Gauge	2 Gauge	Digitec mod. C108N (p. 219)	Autotec mod. C098N (p. 219)
<b>C058-02</b>	▼	▼			
<b>C058-03</b>	▼		▼		
<b>C058-04D</b>	▼			▼	
<b>C058-05A *</b>	▼				▼

**COMPRESSION TESTING MACHINE HIGH-END MODELS**

TO TEST CUBES UP TO 200 MM SIDE AND CYLINDERS UP TO 280 MM HEIGHT

STANDARDS: ASTM C39 | AASHTO T22 | BS 1610 | GOST 10180-2012



2000 KN CAPACITY

**CYBER-PLUS OR SERVO-PLUS EVOLUTION** DIGITAL TOUCH SCREEN DISPLAY

Cyber and Servo-Plus models have robust and reliable electronic controller, 5.7" touch screen color display. 2 USB ports, 1 SD port, 8 channels for pressure transducers (force measurement) or displacement transducers (Elastic Modulus and Poisson ratio measurement).

**INVERTER**

For a further improvement of energy efficiency and silent operation, (optional device code C099N).  
Technical details, p. 223

**BARCODE**

Scanner for specimen file/identification, (optional device code C099-01).  
Details, p. 223



C058-04N + C127N + C111-26 + C111-22



C058-05N + C104-04 + C127N + C111-26 + C111-22 + C121-05

COMPRESSION 2000 kN capacity

**LOAD MEASURING SYSTEM**

MODEL	Motorized	Cyber-Plus Evolution mod. C109N (p. 224)	Servo-Plus Evolution mod. C104N (p. 224)
<b>C058-04N</b>	▼	▼	
<b>C058-05N *</b>	▼		▼

\* Servo-Plus/Autotec models feature fully automatic power pack - electrovalve operated test start (no manual lever).

**ACCESSORIES FOR 2000 KN MACHINES FROM MOD C058-02 TO C058-05N**

**C111-26** DISTANCE PIECE, 76 mm high for cubes 200 mm side

**C111-26 + C111-22**

DISTANCE PIECES, 76+50 mm high for cubes 200 and 150 mm side

**C111-26 + C111-22 + C111-22**

DISTANCE PIECES 76+50+50 mm high for cubes 200, 150 and 100 mm side

**C111-22** DISTANCE PIECE 50 mm high

**C111-31** DISTANCE PIECE 20 mm high

**C110-15** LOWER COMPRESSION PLATEN, Ø 216x40 mm, hardened and rectified to test cubes 100 and 150 mm, as an alternative to the standard platen Ø 278 mm  
 Technical details: see p. 319

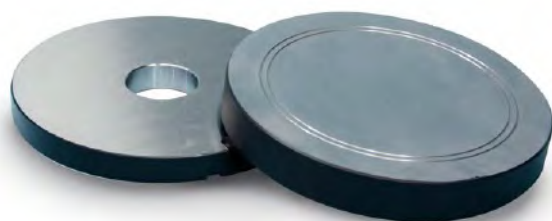

**C110-15**

**C112-10** UPPER+LOWER LARGE COMPRESSION PLATENS 245x510x55 mm WITH SEAT BALL to test **also** blocks.



**C112-10**

**C127N** GRAPHIC PRINTER on thermo-paper on board for digital models

**C127-11** THERMO-PAPER roll for printer (pack of 10 rolls)

**C121-05** SAFETY GUARDS, polycarbonate, with hinges and lock, to CE Directive. See p. 317

**C121-51** STOP SWITCH on safety guard.  
 See p. 317

**C115-01** TWO WAY HYDRAULIC VALVE, connected to the motorized pumping unit of the machine to activate a second frame. Technical details: see p. 318

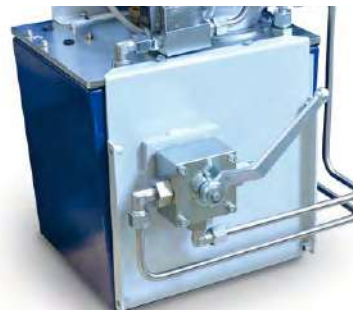

**C115-01**

**C097-05** CALIBRATION CLASS 1, starting from 1% of the full range. With a special calibration procedure it is possible to grant Class 1 practically on the full range of the compression machine. Applicable only on digital machines.

**C097-01** DUAL LOW CAPACITY DIGITAL RANGE, complete with **appropriate pressure transducer**, only for digital machines. Recommended range 0-250kN.  
 Technical details: see p. 313



**C097-01**

**C107-01** AUTO-CENTERING DEVICE for cubes 100 and 150 mm side, and cylinders Ø 100 mm  
 Technical details: see p. 316



**C107-01**

- C100** SPLITTING TENSILE test device for cylinders.  
EN 12390-6 | ASTM C496  
Technical details and other models: see p. 314

**C100**

- C103** SPLITTING TENSILE test device for self blocking pavers and cubes. EN 1338, 12390-6.  
Technical details: see p. 314

**C103**

- C106** FLEXURAL TEST DEVICE for concrete beams.  
EN 12390-5 | ASTM C78, C293 | AASHTO T97  
Technical details: see p. 315

**C106**

- E170** COMPRESSION DEVICE to test cement specimens 40.1x40 mm EN 196 | ASTM C349  
Technical details and other models: see p. 315

**E170**

- C126** BENCH to hold the compression machine. See p. 317

- C104-04** CONSOLE HOUSING THE SERVO-PLUS EVOLUTION  
The pump assembly lined with sound proofing material for noise reduction and the digital system are encased to enhance the design and look of the machine.  
Technical details: see p. 312

**C058-05N****C104-04**

- C099N** INVERTER DEVICE  
**NEW** Applicable only on Cyber-Plus and Servo-Plus Evolution machines.  
Technical details: see p. 223

**C104-06****C099N**

- C104-06** CONSOLE HOUSING THE CYBER-PLUS EVOLUTION  
**NEW** New console internally lined with sound proofing material, to reduce noise and allow for the inverter integration. Detail: see p. 223

#### SOFTWARE for DIGITEC / AUTOTEC or CYBER / SERVO PLUS models

<b>C109-10 (N)*</b>	SOFTWARE for compression tests
<b>C123 (N)*</b>	SOFTWARE Servonet for remote control through PC
<b>C109-11 (N)*</b>	SOFTWARE for flexural tests
<b>C109-12 (N)*</b>	SOFTWARE for splitting tensile

Technical detail: see p. 18

**(N)\*** for Cyber - Servo Plus models.

## COMPRESSION TESTING MACHINE 2000 KN CAPACITY

TO TEST BLOCKS MAX. 500X300 MM, CUBES UP TO 300 MM SIDE AND CYLINDERS UP TO Ø 160X320 MM

STANDARDS: EN 772-1 | ASTM C39, C140, C1314 | AASHTO T22 | NF P18-411 | BS 1610, 6073 | GOST 10180-2012

### DIAL GAUGES MODELS

- Gauges Ø 250 mm with specific resistance scales for cubes 150 mm and cylinders Ø 150 - 160 mm
- Gauges divisions: 2000 kN div. 5 kN  
600 kN div. 2 kN

### MAIN FEATURES FOR ALL MODELS

- Max. vertical daylight: 336 mm
- Horizontal daylight between columns: 324 mm
- Compression platens 510x320x55 mm
- High stiffness and heavy weight 4 columns frame (german-style).
- Calibration accuracy: Class 1
- Max. ram travel 55 mm approx.
- Power supply: 230V 1ph 50Hz 750W
- Dimensions: 870x600x1400 mm approx.
- Weight: 850...900



C077D + C127N + C105 + C111-08



C078A + C105 + C111-08

COMPRESSION 2000 kN capacity

LOAD MEASURIG SYSTEM

MODEL	Motorized	1 Gauge	2 Gauge	Digitec mod. C108N (p. 219)	Autotec mod. C098N (p. 219)
<b>C075</b>	▼	▼			
<b>C076</b>	▼		▼		
<b>C077D</b>	▼			▼	
<b>C078A *</b>	▼				▼

## COMPRESSION TESTING MACHINE HIGH-END MODELS

TO TEST BLOCKS MAX. 500X300 MM, CUBES UP TO 300 MM SIDE AND CYLINDERS UP TO Ø 160X320 MM  
STANDARDS: EN 772-1 | ASTM C39, C140, C1314 | AASHTO T22 | NF P18-411 | BS 1610, 6073 | GOST 10180-2012

2000 KN CAPACITY



**CYBER-PLUS OR SERVO-PLUS EVOLUTION** DIGITAL TOUCH SCREEN DISPLAY



Cyber and Servo-Plus models have robust and reliable electronic controller, 5.7" touch screen color display. 2 USB ports, 1 SD port, 8 channels for pressure transducers (force measurement) or displacement transducers (Elastic Modulus and Poisson ratio measurement).

**INVERTER**

For a further improvement of energy efficiency and silent operation, (optional device code C099N).  
Technical details, p. 223



**BARCODE**

Scanner for specimen file/identification, (optional device code C099-01).  
Details, p. 223



C077N + C127N + C111-22

C078N + C104-04 + C127N + C105 + C111-08

COMPRESSION 2000 kN capacity

LOAD MEASURING SYSTEM

MODEL	Motorized	Cyber-Plus Evolution mod. C109N (p. 224)	Servo-Plus Evolution mod. C104N (p. 224)
<b>C077N</b>	▼	▼	
<b>C078N *</b>	▼		▼

\* Servo-Plus/Autotec models feature fully automatic power pack - electrovalve operated test start (no manual lever).



**ACCESSORIES FOR 2000 KN BLOCKS MACHINES FROM MOD. C075 TO C078N**

**C111-31** DISTANCE PIECE, 20 mm high for cylinders Ø 150x300 mm

**C111-04** DISTANCE PIECE, 126 mm high for cubes 200 mm side

**C111-05** DISTANCE PIECES, 126+50 mm high for cubes 200 and 150 mm side

**C111-06** DISTANCE PIECES 126+50+50 mm high for cubes 200, 150 and 100 mm side

**C111-22** DISTANCE PIECE 50 mm high

 **Note:** The cylinders Ø 160x320 mm do not require any distance piece.

**C111-50** DISTANCE PIECE, it eliminates the heavy procedure to lift the lower rectangular platen and to add distance pieces. Technical details: see p. 320



**C111-50**

AS AN ALTERNATIVE:

**C112-05** KIT of 4 HANDLES to lift the lower platen, making the positioning of distance pieces easier. Technical details: see p. 320



**C112-05**

AS AN ALTERNATIVE:

**C105** CENTRAL SCREW, to get easier the adjustment between the big sized compression platens. Technical details: see p. 313

**C111-27** SLOTTED DISTANCE PIECE, 20 mm high, for central screw

**C111-23** SLOTTED DISTANCE PIECE, 50 mm high for central screw

**C111-28** SLOTTED DISTANCE PIECE, 76 mm high for central screw

**C111-08** SLOTTED DISTANCE PIECE, 126 mm high for central screw

**C127N** GRAPHIC PRINTER on thermo-paper on board for digital models

**C127-11** THERMO-PAPER roll for printer (pack of 10 rolls)

**C121-01** SAFETY GUARDS, polycarbonate, with hinges and lock, to CE Directive. See p. 317

**C121-51** STOP SWITCH on safety guard. See p. 317

**C107-10** CAPPING RETAINERS (set of two) for cylinders 150 mm and 6". Other models: see p. 316

**C107-20** NEOPRENE PADS (set of two) for cylinders Ø 150 mm 60 shore A. Other models: see p. 316



**C107-10 + C107-20**



**C110-30**

**C110-30** UPPER COMPRESSION PLATEN+SPHERICAL SEAT, to fix on the testing machine, in replacement of the standard platen + seat to obtain an increased vertical clearance of the testing chamber and to meet ASTM C39, C1231 and AASHTO T22, T851 Platen dimensions: Ø 165x30 mm Weight: 10 kg approx. Technical details: see p. 316

**C115-01** TWO WAY HYDRAULIC VALVE, connected to the motorized pumping unit of the machine to activate a second frame. Technical details: see p. 318



**C115-01**

**C097-05** CALIBRATION CLASS 1, starting from 1% of the full range. With a special calibration procedure it is possible to grant Class 1 practically on the full range of the compression machine. Applicable only on digital machines.

**C097-01** DUAL LOW CAPACITY DIGITAL RANGE, complete with appropriate pressure transducer, only for digital machines. Recommended range 0-250kN. Technical details: see p. 313



**C097-01**

**C100** SPLITTING TENSILE test device for cylinders. EN 12390-6 | ASTM C496 Technical details and other models: see p. 314



**C100**

- C103** SPLITTING TENSILE test device for self blocking pavers and cubes. EN 1338, 12390-6.  
Technical details: see p. 314

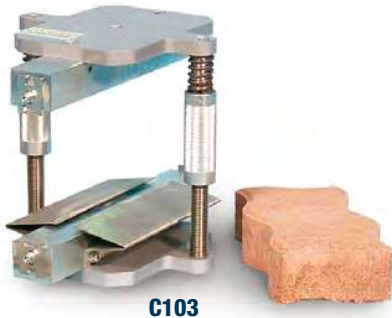
**C103**

AS AN ALTERNATIVE:

- C103-01** SPLITTING TENSILE test device for self blocking pavers and cubes having max. dimensions 300x500 mm, directly fixed on the large compression platens. EN 1338, 12390-6. Technical details: see p. 314

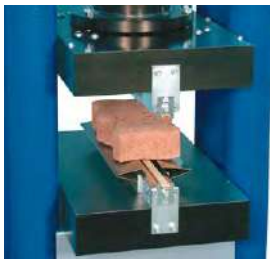
**C103-01**

- C106** FLEXURAL TEST DEVICE for concrete beams. EN 12390-5 | ASTM C78, C293 | AASHTO T97  
Technical details: see p. 315

**C106**

- E170** COMPRESSION DEVICE to test cement specimens 40.1x40 mm EN 196 | ASTM C349  
Technical details and other models: see p. 315

**E170**

- C126** BENCH to hold the compression machine. See p. 317

- C104-04** CONSOLE HOUSING THE SERVO-PLUS EVOLUTION  
The pump assembly **lined** with sound proofing material for noise reduction and the digital system are encased to enhance the design and look of the machine.  
Technical details: see p. 312

**C078N****C104-04**

- C099N** INVERTER DEVICE  
**NEW** Applicable only on Cyber-Plus and Servo-Plus Evolution machines.  
Technical details: see p. 223

**C104-06****C099N**

- C104-06** CONSOLE HOUSING THE CYBER-PLUS EVOLUTION  
**NEW** New console internally lined with sound proofing material, to reduce noise and allow for the inverter integration. Detail: see p. 223

#### SOFTWARE for DIGITEC / AUTOTEC or CYBER / SERVO PLUS models

<b>C109-10 (N)*</b>	SOFTWARE for compression tests
<b>C123 (N)*</b>	SOFTWARE <b>Servonet</b> for remote control through PC
<b>C109-11 (N)*</b>	SOFTWARE for flexural tests
<b>C109-12 (N)*</b>	SOFTWARE for splitting tensile

Technical detail: see p. 18

**(N)\*** for Cyber - Servo Plus models.

## COMPRESSION TESTING MACHINE 3000 KN CAPACITY

TO TEST CUBES UP TO 200 MM SIDE AND CYLINDERS UP TO Ø 160X320 MM

STANDARDS: ASTM C39 | AASHTO T22 | NF P18-411 | BS 1610 | GOST 10180-2012

### DIAL GAUGES MODELS

- Gauges Ø 250 mm with specific resistance scales for cubes 150 mm and cylinders Ø 150 - 160 mm
- Gauges divisions: 3000 kN div. 10 kN  
600 kN div. 2 kN

### MAIN FEATURES FOR ALL MODELS

- Max. vertical daylight: 336 mm
- Horizontal daylight between columns: 272 mm
- Compression platens Ø 287 mm
- High stiffness and heavy weight 4 columns frame (german-style).
- Calibration accuracy: Class 1
- Max. ram travel 55 mm approx.
- Power supply: 230V 1ph 50Hz 750W
- Dimensions: 860x470x1450 mm approx.
- Weight: 1050...1120 kg



C070D + C111-05



C071A + C127N + C111-05 + C121-07

COMPRESSION 3000 kN capacity

LOAD MEASURIG SYSTEM

MODEL	Motorized	LOAD MEASURIG SYSTEM			
		1 Gauge	2 Gauge	Digitec mod. C108N (p. 219)	Autotec mod. C098N (p. 219)
<b>C068</b>	▼	▼			
<b>C069</b>	▼		▼		
<b>C070D</b>	▼			▼	
<b>C071A *</b>	▼				▼

**COMPRESSION TESTING MACHINE HIGH-END MODELS**

TO TEST CUBES UP TO 200 MM SIDE AND CYLINDERS UP TO Ø 160X320 MM

STANDARDS: ASTM C39 | AASHTO T22 | NF P18-411 | BS 1610 | GOST 10180-2012



3000 KN CAPACITY

**CYBER-PLUS OR SERVO-PLUS EVOLUTION** DIGITAL TOUCH SCREEN DISPLAY

Cyber and Servo-Plus models have robust and reliable electronic controller, 5.7" touch screen color display. 2 USB ports, 1 SD port, 8 channels for pressure transducers (force measurement) or displacement transducers (Elastic Modulus and Poisson ratio measurement).

**INVERTER**For a further improvement of energy efficiency and silent operation, (optional device code C099N).  
Technical details, p. 223**NEW****BARCODE**Scanner for specimen file/identification, (optional device code C099-01).  
Details, p. 223**NEW**

C070N + C127N + C111-05



C071N + C104-04 + C127N + C111-05 + C121-07

COMPRESSION 3000 kN capacity

LOAD MEASURING SYSTEM

MODEL	Motorized	Cyber-Plus Evolution mod. C109N (p. 224)	Servo-Plus Evolution mod. C104N (p. 224)
<b>C070N</b>	▼	▼	
<b>C071N *</b>	▼		▼

\* Servo-Plus/Autotec models feature fully automatic power pack - electrovalve operated test start (no manual lever).

**ACCESSORIES FOR 3000 kN MACHINES FROM MOD. C068 TO C071N**

**C111-31** DISTANCE PIECE, 20 mm high for cylinders Ø 150x300 mm

**C111-04** DISTANCE PIECE, 126 mm high for cubes 200 mm side

**C111-05** DISTANCE PIECES, 126+50 mm high for cubes 200 and 150 mm side

**C111-06** DISTANCE PIECES 126+50+50 mm high for cubes 200, 150 and 100 mm side

**C111-07 + C111-31** DISTANCE PIECES, high 50+50+20 mm for cylinders Ø 100x200 mm

**C111-22** DISTANCE PIECE, 50 mm high

**C110-15** LOWER COMPRESSION PLATEN, Ø 216x40 mm, hardened and rectified to test cubes 100 and 150 mm, as an alternative to the standard platen Ø 278 mm  
 Technical details: see p. 319

 **Note:** the cylinders Ø 160x320 mm do not require any distance piece.



**C110-15**

**C112-10** UPPER+LOWER LARGE COMPRESSION PLATENS 245x510x55 mm complete with SEAT BALL to test also blocks.

**C127N** GRAPHIC PRINTER on thermo-paper on board for digital models

**C127-11** THERMO-PAPER roll for printer (pack of 10 rolls)

**C121-07** SAFETY GUARDS, polycarbonate, with hinges and lock, to CE Directive. p. 317

**C121-51** STOP SWITCH on safety guard. See p. 319

**C107-10** CAPPING RETAINERS (set of two) for cylinders Ø 150 mm and 6". Other models: see p. 316

**C107-12** CAPPING RETAINERS (set of two) for cylinders Ø 160 mm

**C107-20** NEOPRENE PADS (set of two) for cylinders Ø 150mm 60 shore A

**C107-25** NEOPRENE PADS (set of two) for cylinders Ø 160 mm 60 shore A. Other models: see p. 316



**C112-10**



**C107-10 + C107-20**

**C110-30** UPPER COMPRESSION PLATEN+SPHERICAL SEAT, to fix on the testing machine, in replacement of the standard platen + seat to obtain an increased vertical clearance of the testing chamber and to meet the ASTM C39, C1231 and AASHTO T22, T851  
 Platen dimensions: Ø 165x30 mm  
 Weight: 10 kg approx.  
 Technical details: see p. 316



**C110-30**

**C115-01** TWO WAY HYDRAULIC VALVE, connected to the motorized pumping unit of the machine to activate a second frame. Technical details: see p. 318



**C115-01**

**C097-01** DUAL LOW CAPACITY DIGITAL RANGE, complete with appropriate pressure transducer, only for digital machines. Recommended range 0-250kN.  
 Technical details: see p. 313



**C097-01**

**C097-05** CALIBRATION CLASS 1, starting from 1% of the full range. With a special calibration procedure it is possible to grant Class 1 practically on the full range of the compression machine. Applicable only on digital machines.

**C107-01** AUTO-CENTERING DEVICE for cubes 100 and 150 mm side, and cylinders Ø 100 and 150 mm.  
 Technical details: see p. 316



**C107-01**

- C100** SPLITTING TENSILE test device for cylinders.  
EN 12390-6 | ASTM C496  
Technical details and other models: see p. 314

**C100**

- C103** SPLITTING TENSILE test device for self blocking pavers and cubes. EN 1338, 12390-6.  
Technical details: see p. 314

**C103**

- C106** FLEXURAL TEST DEVICE for concrete beams.  
EN 12390-5 | ASTM C78, C293 | AASHTO T97  
Technical details: see p. 315

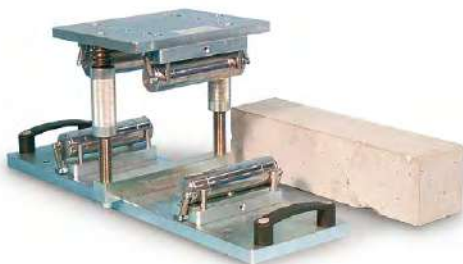
**C106**

- E170** COMPRESSION DEVICE to test cement specimens  
40.1x40 mm EN 196 | ASTM C349  
Technical details and other models: see p. 315

**E170**

- C126** BENCH to hold the compression machine. See p. 317

- C104-04** CONSOLE HOUSING THE SERVO-PLUS EVOLUTION  
The pump assembly **lined** with sound proofing material for noise reduction and the digital system are encased to enhance the design and look of the machine.  
Technical details: see p. 314

**C071N****C104-04**

- C099N** INVERTER DEVICE  
**NEW** Applicable only on Cyber-Plus and Servo-Plus Evolution machines.  
Technical details: see p. 223

**C104-06****C099N**

- C104-06** CONSOLE HOUSING THE CYBER-PLUS EVOLUTION  
**NEW** New console internally lined with sound proofing material, to reduce noise and allow for the inverter integration. Detail: see p. 223

#### SOFTWARE for DIGITEC / AUTOTEC or CYBER / SERVO PLUS models

<b>C109-10 (N)*</b>	SOFTWARE for compression tests
<b>C123 (N)*</b>	SOFTWARE <b>Servonet</b> for remote control through PC
<b>C109-11 (N)*</b>	SOFTWARE for flexural tests
<b>C109-12 (N)*</b>	SOFTWARE for splitting tensile

Technical detail: see p. 18

**(N)\*** for Cyber - Servo Plus models.

## COMPRESSION TESTING MACHINE 3000 KN CAPACITY

TO TEST BLOCKS MAX. 500X300 MM, CUBES UP TO 300 MM SIDE AND CYLINDERS UP TO Ø 160X320 MM

STANDARDS: EN 772-1 | ASTM C39, C140, C1314 | AASHTO T22 | NF P18-411 | BS 1610, 6073 | GOST 10180-2012

### DIAL GAUGES MODELS

- Gauges Ø 250 mm with specific resistance scales for cubes 150 mm and cylinders Ø 150 - 160 mm
- Gauges divisions: 3000 kN div. 10 kN  
600 kN div. 2 kN

### MAIN FEATURES FOR ALL MODELS

- Max. vertical daylight between platens: 336 mm
- Horizontal daylight between columns: 340 mm
- Compression platens 510x320x55 mm
- High stiffness and heavy weight 4 columns frame (german-style).
- Calibration accuracy: Class 1
- Max. ram travel 55 mm approx.
- Power supply: 230V 1ph 50Hz 750W
- Dimensions: 900x600x1500 mm approx.
- Weight: 1150...1220 kg



C079-05D + C105 + C127N + C111-28



C079-06A + C105 + C111-28

COMPRESSION 3000 kN capacity

LOAD MEASURIG SYSTEM

MODEL	Motorized	1 Gauge	2 Gauge	Digitec mod. C108N (p. 219)	Autotec mod. C098N (p. 219)
<b>C079-03</b>	▼	▼			
<b>C079-04</b>	▼		▼		
<b>C079-05D</b>	▼			▼	
<b>C079-06A *</b>	▼				▼

## COMPRESSION TESTING MACHINE HIGH-END MODELS

TO TEST BLOCKS MAX. 500X300 MM, CUBES UP TO 300 MM SIDE AND CYLINDERS UP TO Ø 160X320 MM  
STANDARDS: EN 772-1 | ASTM C39, C140, C1314 | AASHTO T22 | NF P18-411 | BS 1610, 6073 | GOST 10180-2012

### 3000 KN CAPACITY



**CYBER-PLUS OR SERVO-PLUS EVOLUTION** DIGITAL TOUCH SCREEN DISPLAY



Cyber and Servo-Plus models have robust and reliable electronic controller, 5.7" touch screen color display. 2 USB ports, 1 SD port, 8 channels for pressure transducers (force measurement) or displacement transducers (Elastic Modulus and Poisson ratio measurement).

**INVERTER**

For a further improvement of energy efficiency and silent operation, (optional device code C099N).  
Technical details, p. 223

**NEW**

**BARCODE**

Scanner for specimen file/identification, (optional device code C099-01).  
Details, p. 223

**NEW**



C079-05N + C127N + C111-22

C079-06N + C105 + C127N + C104-04 + C111-28

COMPRESSION 3000 kN capacity

LOAD MEASURING SYSTEM

MODEL	Motorized	Cyber-Plus Evolution mod. C109N (p. 224)	Servo-Plus Evolution mod. C104N (p. 224)
<b>C079-05N</b>	▼	▼	
<b>C079-06N *</b>	▼		▼

\* Servo-Plus/Autotec models feature fully automatic power pack - electrovalve operated test start (no manual lever).



**ACCESSORIES FOR 3000 kN BLOCKS MACHINES FROM MOD. C079-03 TO C079-06N**

**C111-31** DISTANCE PIECE, 20 mm high for cylinders Ø 150x300 mm

**C111-04** DISTANCE PIECE, 126 mm high for cubes 200 mm side

**C111-05** DISTANCE PIECES, 126+50 mm high for cubes 200 and 150 mm side

**C111-06** DISTANCE PIECES 126+50+50 mm high for cubes 200, 150 and 100 mm side

**C111-22** DISTANCE PIECE 50 mm high

 **Note:** The cylinders Ø 160x320 mm do not require any distance piece.

**C111-50** DISTANCE PIECE, it eliminates the heavy procedure to lift the lower rectangular platen and to add distance pieces. Technical details: see p. 320



**C111-50**

AS AN ALTERNATIVE:

**C112-05** KIT of 4 HANDLES to lift the lower platen, making the positioning of distance pieces easier. Technical details: see p. 320



**C112-05**

AS AN ALTERNATIVE:

**C105** CENTRAL SCREW, to get easier the adjustment between the big sized compression platens. Technical details: see p. 313

**C111-27** SLOTTED DISTANCE PIECE, 20 mm high, for central screw

**C111-23** SLOTTED DISTANCE PIECE, 50 mm high for central screw

**C111-28** SLOTTED DISTANCE PIECE, 76 mm high for central screw

**C111-08** SLOTTED DISTANCE PIECE, 126 mm high for central screw

**C127N** GRAPHIC PRINTER on thermo-paper on board for digital models

**C127-11** THERMO-PAPER roll for printer (pack of 10 rolls)

**C121-08** SAFETY GUARDS, polycarbonate, with hinges and lock, to CE Directive. See p. 317

**C121-51** STOP SWITCH on safety guard. See p. 317

**C107-10** CAPPING RETAINERS (set of two) for cylinders 150 mm and 6". Other models: see p. 316

**C107-20** NEOPRENE PADS (set of two) for cylinders Ø 150 mm 60 shore A. Other models: see p. 316



**C107-10 + C107-20**



**C110-30**

**C110-30** UPPER COMPRESSION PLATEN+SPHERICAL SEAT, to fix on the testing machine, in replacement of the standard platen + seat to obtain an increased vertical clearance of the testing chamber and to meet the ASTM C39, C1231 and AASHTO T22, T851 Platen dimensions: Ø 165x30 mm Weight: 10 kg approx. Technical details: see p. 316

**C115-01** TWO WAY HYDRAULIC VALVE, connected to the motorized pumping unit of the machine to activate a second frame. Technical details: see p. 318



**C115-01**

**C097-05** CALIBRATION CLASS 1, starting from 1% of the full range. With a special calibration procedure it is possible to grant Class 1 practically on the full range of the compression machine. Applicable only on digital machines.

**C097-01** DUAL LOW CAPACITY DIGITAL RANGE, complete with appropriate pressure transducer, only for digital machines. Recommended range 0-250kN. Technical details: see p. 313



**C097-01**

**C100** SPLITTING TENSILE test device for cylinders. EN 12390-6 | ASTM C496 Technical details and other models: see p. 314



**C100**

- C103** SPLITTING TENSILE test device for self blocking pavers and cubes. EN 1338, 12390-6.  
Technical details: see p. 314

**C103**

AS AN ALTERNATIVE:

- C103-01** SPLITTING TENSILE test device for self blocking pavers and cubes having max. dimensions 300x500mm, directly fixed on the large compression platens.  
EN 1338, 12390-6. Technical details: see pag. 314

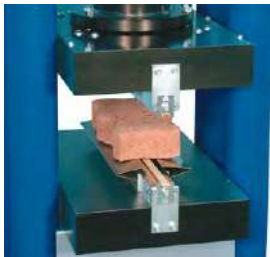
**C103-01**

- C106** FLEXURAL TEST DEVICE for concrete beams.  
EN 12390-5 | ASTM C78, C293 | AASHTO T97  
Technical details: see p. 315

**C106**

- E170** COMPRESSION DEVICE to test cement specimens 40.1x40 mm EN 196 | ASTM C349  
Technical details and other models: see p. 315

**E170**

- C126** BENCH to hold the compression machine. See p. 317

- C104-04** CONSOLE HOUSING THE SERVO-PLUS EVOLUTION  
The pump assembly **lined** with sound proofing material for noise reduction and the digital system are encased to enhance the design and look of the machine.  
Technical details: see p. 312

**C079-06N****C104-04**

- C099N** INVERTER DEVICE  
**NEW** Applicable only on Cyber-Plus and Servo-Plus Evolution machines.  
Technical details: see p. 223

**C104-06****C099N**

- C104-06** CONSOLE HOUSING THE CYBER-PLUS EVOLUTION  
**NEW** New console internally lined with sound proofing material, to reduce noise and allow for the inverter integration. Detail: see p. 223

#### SOFTWARE for DIGITEC / AUTOTEC or CYBER / SERVO PLUS models

<b>C109-10 (N)*</b>	SOFTWARE for compression tests
<b>C123 (N)*</b>	SOFTWARE <b>Servonet</b> for remote control through PC
<b>C109-11 (N)*</b>	SOFTWARE for flexural tests
<b>C109-12 (N)*</b>	SOFTWARE for splitting tensile

Technical detail: see p. 18

**(N)\*** for Cyber - Servo Plus models.

**COMPRESSION TESTING MACHINE 5000 KN CAPACITY HIGH-END MODELS**

TO TEST CUBES UP TO 300 MM SIDE AND CYLINDERS UP TO Ø 250X500 MM

STANDARDS: BS 1610 | NF P18-411 | ASTM C39 | AASHTO T22 | GOST 10180-2012



5000 KN CAPACITY

**MAIN FEATURES FOR ALL MODELS**

- Max. vertical daylight: 530 mm
- Horizontal daylight between columns: 340 mm
- Compression platens 310x310 mm
- Calibration accuracy: Class 1
- Max. ram travel 60 mm approx.
- High stiffness and heavy weight 4 columns frame (german-style).
- Power supply: 230V 1ph 50Hz 750W
- Dimensions: 1200x900x1900 mm approx.
- Weight: 2800...2900 kg approx.



**CYBER-PLUS OR SERVO-PLUS EVOLUTION**  
DIGITAL TOUCH SCREEN DISPLAY

Cyber and Servo-Plus models have robust and reliable electronic controller, 5.7" touch screen color display. 2 USB ports, 1 SD port, 8 channels for pressure transducers (force measurement) or displacement transducers (Elastic Modulus and Poisson ratio measurement).

**INVERTER**



For a further improvement of energy efficiency and silent operation, (optional device code C099N). Technical details, p. 223

**BARCODE**

Scanner for specimen file/identification, (optional device code C099-01). Details, p. 223



C086-02N + C127N



C086-03N + C086-10

COMPRESSION 5000 kN capacity

**LOAD MEASURING SYSTEM**

MODEL	Motorized	Cyber-Plus Evolution mod. C109N (p. 224)	Servo-Plus Evolution mod. C104N (p. 224)
<b>C086-02N</b>	▼	▼	
<b>C086-03N *</b>	▼		▼

\* Servo-Plus model feature fully automatic power pack - electrovalve operated test start (no manual lever).

## ACCESSORIES FOR 5000 KN MACHINES

**C086-10** DISTANCE PIECE, 50 mm high

**C086-11** DISTANCE PIECE, 25 mm high

**Note:** Vertical daylight of the compression platens is 530 mm. The operator will have to buy the needed distance pieces to reduce the daylight between the compression platens to get the correct daylight of the specimen under test plus approx. 10 to 15 mm



**C112-11**

**C112-11** UPPER+LOWER LARGE COMPRESSION PLATENS+SEAT BALL 310x510x55 mm to test **also** blocks. It is necessary to have also the sliding rail carriage mod. C117

**C117** SLIDING RAIL CARRIAGE, for an easy removal of the large block upper platen

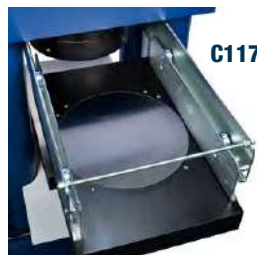

**C117**

**C127N** GRAPHIC PRINTER on thermo-paper on board

**C127-11** THERMO-PAPER roll for printer (pack of 10 rolls)

**C121-04** SAFETY GUARDS, polycarbonate, with hinges and lock, to CE Directive. See p. 317

**C121-51** STOP SWITCH on safety guard. See p. 317

**C115-01** TWO WAY HYDRAULIC VALVE, connected to the motorized pumping unit of the machine to activate a second frame. Technical details: see p. 318



**C097-01**

**C097-01** DUAL LOW CAPACITY DIGITAL RANGE, complete with **appropriate pressure transducer**. Recommended range 0-250kN. Technical details: see p. 313



**C097-01**

**C097-05** CLASS 1, starting from 1% of the full range. With a special calibration procedure it is possible to grant Class 1 practically on the full range of the compression machine.

**C100**

SPLITTING TENSILE test device for cylinders. EN 12390-6 | ASTM C496  
Technical details and other models: see p. 314



**C100**

**C103**

SPLITTING TENSILE test device for self blocking pavers and cubes. EN 1338, 12390-6.  
Technical details: see p. 314



**C103**

**C106**

FLEXURAL TEST DEVICE for concrete beams. EN 12390-5 | ASTM C78, C293 | AASHTO T97  
Technical details: see p. 315



**C106**

**E170**

COMPRESSION DEVICE to test cement specimens 40.1x40 mm EN 196 | ASTM C349  
Technical details and other models: see p. 317



**E170**

**C099N**  **NEW**

## INVERTER DEVICE

Applicable only on Cyber-Plus and Servo-Plus Evolution machines.  
Technical details: see p. 223



**C099N**

SOFTWARE for  
CYBER / SERVO PLUS models

<b>C109-10N</b>	SOFTWARE for compression tests
<b>C123N</b>	SOFTWARE <b>Servonet</b> for remote control through PC
<b>C109-11N</b>	SOFTWARE for flexural tests
<b>C109-12N</b>	SOFTWARE for splitting tensile

Technical detail: see p. 18

## COMPRESSION AND FLEXURAL FRAMES ONLY

The compression frame is supplied complete with upper compression platen + spherical seat and lower compression platen, pressure transducer and flexible connection pipe to separate control console.

The two-way hydraulic valve mod. C115-01 (see p. 318), the distance pieces and the safety guards are not included and must be ordered separately.

Code	Capacity	Technical details at pages	Cube/Cylinder	Blocks	ASTM Spec.	EN High Stability Spec.
C036F	1300/1500 kN	230, 234	▼		▼	
C051F	2000 kN	238	▼		▼	
C058F	2000 kN	242	▼		▼	
C073F	2000 kN	246	▼	▼	▼	
C066F	3000 kN	250	▼		▼	
C079-01F	3000 kN	254	▼	▼	▼	
C089F	2000 kN	262	▼			▼
C089-22F	2000 kN	266	▼	▼		▼
C089-06F	3000 kN	270	▼			▼
C089-15F	3000 kN	274	▼	▼		▼
C090F	150 kN	290	beams		▼	▼
C091-01F*	150 kN	292	multipurpose		▼	▼
C090-06F*	200 kN	294	multipurpose		▼	▼
C095F*	320 kN	296	multipurpose		▼	▼
C096F*	360 kN	300	multipurpose		▼	▼

\*Note: rollers are not included



C051F



C089F



C095F



C090F



C090-06F



C091-01F

## COMPRESSION TESTING MACHINES TESTED FOR HIGH STABILITY

### FOUR COLUMNS PRESTRESSED FRAME

The compression machines **tested for high stability** meet the stringent requirements of the: EN 12390-4 | BS 1881:115 | DIN 51220 | UNI 6686, part 3 | NF P18-411 | UNE 83304 | ASTM C39 | AASHTO T22

The machines are manufactured with specific quality features (processing, tolerances) of frame, piston/cylinder group, spherical seat, compression platens, distance pieces etc., conforming and meeting the high stability verification. (force distribution).

The conformity of the stability is certified with the verification of the self-alignment (foot-meter test) of the machines components and the restraint on movement of the upper spherical seat/platen, by using a special electric strain load column at 5 measuring points which is connected to its suitable datalogger (technical details: see p. 325)

**An incorrect and not uniform load application to the specimen causes irregular, unsatisfactory and premature failure. The obtained compression resistance can be substantially lower than the effective resistance.**

**The most important feature of the high stability frames is their uniform distribution of the applied load on all the specimen surface under test. The sample breakage is satisfactory and the strength results are correct, high and true.**

- The four columns frame is prestressed on 8 ring nuts and the clamping is obtained and checked by a dynamometric spanner, allowing to get a very high stiffness and stability on all load range and to keep these features in the time.
- The spherical seat, in oil bath with null end float, is studied and manufactured to grant, during the starting phase of the test, an accurate self-alignment without frictions of the upper compression platen to the specimen. By applying the load, the ball seating assembly locks and keeps the position until the specimen's failure.
- Piston and cylinder are coupled with high quality packing set.
- Compression platens are hardened over 55 HRC and rectified.



Available in the capacities: 2000 kN | 2000 kN blocks | 3000 kN | 3000 kN blocks | 4000 kN | 5000 kN

Load measuring system: Bourdon type gauge

**Digitec** or **Cyber-Plus Evolution** graphic display unit

Servo-controlled automatic system **Autotec** or **Servo-Plus Evolution** with optional **Servo-Strain** and **Elastic Modulus** determination.

Described and pictured in the next p. 262...281

## COMPRESSION TESTING MACHINE 2000 KN CAPACITY TESTED FOR HIGH STABILITY

TO TEST CUBES UP TO 200 MM SIDE AND CYLINDERS UP TO Ø 160X320 MM

STANDARDS: EN 12390-4 | BS 1881:115 | DIN 51220 | ASTM C39 | NF P18-411 | AASHTO T22 | GOST 10180-2012

### DIAL GAUGES MODELS

- Gauges Ø 250 mm with specific resistance scales for cubes 150 mm and cylinders Ø 150 - 160 mm
- Gauges divisions: 2000 kN div. 5 kN  
600 kN div. 2 kN

### MAIN FEATURES FOR ALL MODELS

- Max. vertical daylight: 334.5 mm
- Horizontal daylight between columns: 260 mm
- Compression platens Ø 287X60 mm
- Calibration accuracy: Class 1
- Max. ram travel 60 mm approx.
- High stiffness and heavy weight 4 columns frame (german-style).
- Power supply: 230V 1ph 50Hz 750W
- Dimensions: 690x400x1400 mm approx.
- Weight: 850...920 kg



C089-02D+C127N+C121-06+C111-13



C089-04A+C127N+C111-13

COMPRESSION 2000 kN High Stability

LOAD MEASURING SYSTEM

MODEL	Motorized	1 Gauge	2 Gauge	Digitec mod. C108N (p. 219)	Autotec mod. C098N (p. 219)
<b>C089</b>	▼	▼			
<b>C089-01</b>	▼		▼		
<b>C089-02D</b>	▼			▼	
<b>C089-04A *</b>	▼				▼

**COMPRESSION TESTING MACHINE TESTED FOR HIGH STABILITY HIGH-END MODELS**

TO TEST CUBES UP TO 200 MM SIDE AND CYLINDERS UP TO Ø 160X320 MM

STANDARDS: EN 12390-4 | BS 1881:115 | DIN 51220 | ASTM C39 | NF P18-411 | AASHTO T22 | GOST 10180-2012

2000 KN CAPACITY

**CYBER-PLUS OR SERVO-PLUS EVOLUTION** DIGITAL TOUCH SCREEN DISPLAY

Cyber and Servo-Plus models have robust and reliable electronic controller, 5.7" touch screen color display. 2 USB ports, 1 SD port, 8 channels for pressure transducers (force measurement) or displacement transducers (Elastic Modulus and Poisson ratio measurement).

**INVERTER**

For a further improvement of energy efficiency and silent operation, (optional device code C099N).  
Technical details, p. 223

**BARCODE**

Scanner for specimen file/identification, (optional device code C099-01).  
Details, p. 223



C089-02N+C111-13



C089-04N+C104-04+C127N+C121-06+C111-13

COMPRESSION 2000 KN High Stability

LOAD MEASURING SYSTEM

MODEL	Motorized	Cyber-Plus Evolution mod. C109N (p. 224)	Servo-Plus Evolution mod. C104N (p. 224)
<b>C089-02N</b>	▼	▼	
<b>C089-04N *</b>	▼		▼

\* Servo-Plus/Autotec models feature fully automatic power pack - electrovalve operated test start (no manual lever).



**ACCESSORIES FOR 2000 KN MACHINES FROM MOD. C089 TO C089-04N**

**C111-32** DISTANCE PIECE, 20 mm high for cylinders Ø 150x300 mm

**C111-12** DISTANCE PIECE, 73+50 mm high for cubes 200 mm side

**C111-13** DISTANCE PIECES, 73+50+50 mm high for cubes 200 and 150 mm side

**C111-14** DISTANCE PIECES, 73+50+50+50 mm high for cubes 200, 150 and 100 mm side

**C111-15** DISTANCE PIECES, 50+50 mm high for cylinders Ø 110x220 mm

**C111-24** DISTANCE PIECE 50 mm high

**C111-25** DISTANCE PIECE 73 mm high

**C110-15** LOWER COMPRESSION PLATEN, Ø 216x40 mm, hardened and rectified to test cubes 100 and 150 mm, as an alternative to the standard platen Ø 278 mm  
 Technical details: see p. 319



**C110-15**

**Note:** the cylinders Ø 160x320 mm do not require any distance piece.

**C127N** GRAPHIC PRINTER on thermo-paper on board for digital models

**C127-11** THERMO-PAPER roll for printer (pack of 10 rolls)

**C121-06** SAFETY GUARDS, polycarbonate, with hinges and lock, to CE Directive. See p. 317

**C121-51** STOP SWITCH on safety guard. See p. 317

**C107-10** CAPPING RETAINERS (set of two) for cylinders Ø 150 mm and 6". Other models: see p. 316

**C107-20** NEOPRENE PADS (set of two) for cylinders Ø 150 mm 60 shore A. Other models: see p. 316



**C107-10 + C107-20**

**C110-30** UPPER COMPRESSION PLATEN+SPHERICAL SEAT, to fix on the testing machine, in replacement of the standard platen + seat to obtain an increased vertical clearance of the testing chamber and to meet the ASTM C39, C1231 and AASHTO T22, T851  
 Platen dimensions: Ø 165x30 mm  
 Weight: 10 kg approx.  
 Technical details: see p. 316



**C110-30**

**C115-01** TWO WAY HYDRAULIC VALVE, connected to the motorized pumping unit of the machine to activate a second frame. Technical details: see p. 318



**C115-01**

**C097-01** DUAL LOW CAPACITY DIGITAL RANGE, complete with appropriate pressure transducer, only for digital machines. Recommended range 0-250kN.  
 Technical details: see p. 313



**C097-01**

**C097-05** CALIBRATION CLASS 1, starting from 1% of the full range. With a special calibration procedure it is possible to grant Class 1 practically on the full range of the compression machine. Applicable only on digital machines.

**C097-08** OFFICIAL ACCREDIA (Equivalent UKAS, ENAC, DAKKS, SAS, COFRAC etc.) HARDNESS CERTIFICATE of upper and lower compression platens. Minimum hardness: 55 HRC. See p. 313

**C107-01** AUTO-CENTERING DEVICE for cubes 100 and 150 mm side, and cylinders Ø 100 and 150 mm.  
 Technical details: see p. 316



**C107-01**

- C100** SPLITTING TENSILE test device for cylinders.  
EN 12390-6 | ASTM C496  
Technical details and other models: see p. 314

**C100**

- C106** FLEXURAL TEST DEVICE for concrete beams.  
EN 12390-5 | ASTM C78, C293 | AASHTO T97  
Technical details: see p. 315

**C106**

- E170** COMPRESSION DEVICE to test cement specimens  
40.1x40 mm EN 196 | ASTM C349  
Technical details and other models: see p. 315

**E170**

- C104-10N** SERVO-STRAIN  
Servocontrolled Software, system of:  
- Load or Strength  
- Displacement  
- Strain  
This system can be used only with Servo-Plus Evolution machine mod. C089-04N. Technical details see p. 282

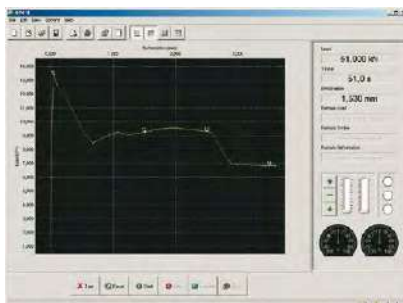
**C104-10N**

- C125N** ELASTIC MODULUS determination of the secant compression on concrete. Automatic system with pace rate control also when releasing the load, applicable only to high stability frames with Servo-Plus Evolution.  
EN 12390-13, 13412, 13286-43, UNI 6556, ASTM C469, ISO 6784, DIN 1048, BS 1888:121  
Technical details: see p. 284

- C126** BENCH to hold the compression machine. See p. 317

- C104-04** CONSOLE HOUSING THE SERVO-PLUS EVOLUTION  
The pump assembly **lined** with sound proofing material for noise reduction and the digital system are encased to enhance the design and look of the machine.  
Technical details: see p. 314

**C089-04N****C104-04**

- C099N** INVERTER DEVICE  
**NEW** Applicable only on Cyber-Plus and Servo-Plus Evolution machines.  
Technical details: see p. 223

**C104-06****C099N**

- C104-06** CONSOLE HOUSING THE CYBER-PLUS EVOLUTION  
**NEW** New console internally lined with sound proofing material, to reduce noise and allow for the inverter integration. Detail: see p. 223

#### SOFTWARE for DIGITEC / AUTOTEC or CYBER / SERVO PLUS models

<b>C109-10 (N)*</b>	SOFTWARE for compression tests
<b>C123 (N)*</b>	SOFTWARE <b>Servonet</b> for remote control through PC
<b>C109-11 (N)*</b>	SOFTWARE for flexural tests
<b>C109-12 (N)*</b>	SOFTWARE for splitting tensile

Technical detail: see p. 18

**(N)\*** for Cyber - Servo Plus models.

## COMPRESSION TESTING MACHINE 2000 KN CAPACITY TESTED FOR HIGH STABILITY

TO TEST BLOCKS MAX 500X300 MM, CUBES UP TO 200 MM SIDE AND CYLINDERS UP TO Ø 160X320 MM

STANDARDS: EN 12390-4, EN 772-1 | BS 1881:115, 6073 | DIN 51220 | NF P18-411 | ASTM C39, C140, C1314 | AASHTO T22 | GOST 10180-2012

### DIAL GAUGES MODELS

- Gauges Ø 250 mm with specific resistance scales for cubes 150 mm and cylinders Ø 150 - 160 mm
- Gauges divisions: 2000 kN div. 10 kN  
600 kN div. 2 kN

### MAIN FEATURES FOR ALL MODELS

- Max. vertical daylight to test blocks: 283 mm
- Horizontal daylight between columns: 340 mm
- Compression platens for blocks: 510x320x55 mm
- Max. vertical daylight to test cubes and cylinders: 334.5 mm
- Compression platens to test cubes, cylinders: Ø 287x60 mm
- Calibration accuracy: Class 1
- Max. ram travel 60 mm approx.
- High stiffness and heavy weight 4 columns frame (german-style).
- Power supply: 230V 1ph 50Hz 750W
- Dimensions: 750x520x1500 mm approx.
- Weight: 1000...1070 kg



C089-21D + C127N



C089-22A + C127N

COMPRESSION 2000 KN High Stability Blocks

LOAD MEASURIG SYSTEM

MODEL	Motorized	1 Gauge	2 Gauge	Digitec mod. C108N (p. 219)	Autotec mod. C098N (p. 219)
<b>C089 B</b>	▼	▼			
<b>C089-01B</b>	▼		▼		
<b>C089-21D</b>	▼			▼	
<b>C089-22A *</b>	▼				▼

## COMPRESSION TESTING MACHINE TESTED FOR HIGH STABILITY **HIGH-END MODELS**

TO TEST BLOCKS MAX 500X300 MM, CUBES UP TO 200 MM SIDE AND CYLINDERS UP TO Ø 160X320 MM

STANDARDS: EN 12390-4, EN 772-1 | BS 1881:115, 6073 | DIN 51220 | NF P18-411 | ASTM C39, C140, C1314 | AASHTO T22 | GOST 10180-2012

# 2000 KN CAPACITY



**CYBER-PLUS OR SERVO-PLUS EVOLUTION** DIGITAL TOUCH SCREEN DISPLAY



Cyber and Servo-Plus models have robust and reliable electronic controller, 5.7" touch screen color display. 2 USB ports, 1 SD port, 8 channels for pressure transducers (force measurement) or displacement transducers (Elastic Modulus and Poisson ratio measurement).

**INVERTER**

For a further improvement of energy efficiency and silent operation, (optional device code C099N).  
Technical details, p. 223



**BARCODE**

Scanner for specimen file/identification, (optional device code C099-01).  
Details, p. 223



**C089-21N**



**C089-22N + C127N + C104-04**

COMPRESSION 2000 KN High Stability Blocks

LOAD MEASURING SYSTEM

MODEL	Motorized	Cyber-Plus Evolution mod. C109N (p. 224)	Servo-Plus Evolution mod. C104N (p. 224)
<b>C089-21N</b>	▼	▼	
<b>C089-22N *</b>	▼		▼

\* Servo-Plus/Autotec models feature fully automatic power pack - electrovalve operated test start (no manual lever).

**ACCESSORIES FOR 2000 KN BLOCKS MACHINES FROM MOD. C089B TO C089-22N**

**C111-32** DISTANCE PIECE, 20 mm high for cylinders Ø 150x300 mm

**C111-12** DISTANCE PIECE, 73+50 mm high for cubes 200 mm side

**C111-13** DISTANCE PIECES, 73+50+50 mm high for cubes 200 and 150 mm side

**C111-14** DISTANCE PIECES 73+50+50+50 mm high for cubes 200, 150 and 100 mm side

**C111-15** DISTANCE PIECES 50+50 mm high for cylinders Ø 110x220 mm

**C111-24** DISTANCE PIECE 50 mm high

**C111-25** DISTANCE PIECE 73 mm high

 **Note:** The cylinders Ø 160x320 mm do not require any distance piece.

**C111-50** DISTANCE PIECE, it eliminates the heavy procedure to lift the lower rectangular platen and to add distance pieces. Technical details: see p. 320

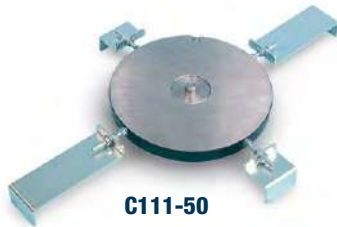

**C111-50**

AS AN ALTERNATIVE:

**C112-05** KIT of 4 HANDLES to lift the lower platen, making the positioning of distance pieces easier. Technical details: see p. 320



**C112-05**

**C117** SLIDING RAIL CARRIAGE, for an easy removal of the upper block platen, to perform tests on blocks or on standard cubes and cylinders.



**C117**

**C127N** GRAPHIC PRINTER on thermo-paper on board for digital models

**C127-11** THERMO-PAPER roll for printer (pack of 10 rolls)

**C121-10** SAFETY GUARDS, polycarbonate, with hinges and lock, to CE Directive. See p. 317

**C121-51** STOP SWITCH on safety guard. See p. 317

**C115-01** TWO WAY HYDRAULIC VALVE, connected to the motorized pumping unit of the machine to activate a second frame. Technical details: see p. 318



**C115-01**

**C097-05** CALIBRATION CLASS 1, starting from 1% of the full range. With a special calibration procedure it is possible to grant Class 1 practically on the full range of the compression machine. Applicable only on digital machines.

**C097-08** OFFICIAL ACCREDIA (Equivalent UKAS, ENAC, DAKKS, SAS, COFRAC etc.) HARDNESS CERTIFICATE of upper and lower compression platens. Minimum hardness: 55 HRC. See p. 313

**C097-01** DUAL LOW CAPACITY DIGITAL RANGE, complete with **appropriate pressure transducer**, only for digital machines. Recommended range 0-250kN. Technical details: see p. 313



**C097-01**

**C100** SPLITTING TENSILE test device for cylinders. EN 12390-6 | ASTM C496  
 Technical details and other models: see p. 314



**C100**

- C103** SPLITTING TENSILE test device for self blocking pavers and cubes. EN 1338, 12390-6.  
Technical details: see p. 314

AS AN ALTERNATIVE:

- C103-01** SPLITTING TENSILE test device for self blocking pavers and cubes having max. dimensions 300x500mm, directly fixed on the large compression platens. EN 1338, 12390-6.  
Technical details: see p. 314



**C103-01**

- C106** FLEXURAL TEST DEVICE for concrete beams. EN 12390-5 | ASTM C78, C293 | AASHTO T97  
Technical details: see p. 315



**C106**

- E170** COMPRESSION DEVICE to test cement specimens 40.1x40 mm EN 196 | ASTM C349  
Technical details and other models: see p. 315



**E170**

- C104-10N** SERVO-STRAIN  
Servocontrolled Software, system of:  
- Load or Strength  
- Displacement  
- Strain

This system can be used only with Servo-Plus Evolution machine mod. C089-22N. Technical details see p. 282

- C125N** ELASTIC MODULUS determination of the secant compression on concrete. Automatic system with pace rate control also when releasing the load, applicable only to high stability frames with Servo-Plus Evolution. EN 12390-13, 13412, 13286-43, UNI 6556, ASTM C469, ISO 6784, DIN 1048, BS 1888:121  
Technical details: see p. 284

- C126** BENCH to hold the compression machine. See p. 317

- C104-04** CONSOLE HOUSING THE SERVO-PLUS EVOLUTION  
The pump assembly **lined** with sound proofing material for noise reduction and the digital system are encased to enhance the design and look of the machine.  
Technical details: see p. 314



**C089-22N**

**C104-04**

- C099N** INVERTER DEVICE  
**NEW** Applicable only on Cyber-Plus and Servo-Plus Evolution machines.  
Technical details: see p. 223



**C104-06**



**C099N**

- C104-06** CONSOLE HOUSING THE CYBER-PLUS EVOLUTION  
**NEW** New console internally lined with sound proofing material, to reduce noise and allow for the inverter integration. Detail: see p. 223

#### SOFTWARE for DIGITEC / AUTOTEC or CYBER / SERVO PLUS models

<b>C109-10 (N)*</b>	SOFTWARE for compression tests
<b>C123 (N)*</b>	SOFTWARE <b>Servonet</b> for remote control through PC
<b>C109-11 (N)*</b>	SOFTWARE for flexural tests
<b>C109-12 (N)*</b>	SOFTWARE for splitting tensile

Technical detail: see p. 18

**(N)\*** for Cyber - Servo Plus models.

## COMPRESSION TESTING MACHINE 3000 KN CAPACITY TESTED FOR HIGH STABILITY

TO TEST CUBES UP TO 200 MM SIDE AND CYLINDERS UP TO Ø 160X320 MM

STANDARDS: EN 12390-4 | BS 1881:115 | DIN 51220 | ASTM C39 | NF P18-411 | AASHTO T22 | GOST 10180-2012

### DIAL GAUGES MODELS

- Gauges Ø 250 mm with specific resistance scales for cubes 150 mm and cylinders Ø 150 - 160 mm
- Gauges divisions: 3000 kN div. 10 kN  
600 kN div. 2 kN

### MAIN FEATURES FOR ALL MODELS

- Max. vertical daylight: 334.5 mm
- Horizontal daylight between columns: 272 mm
- Compression platens Ø 287X60 mm
- Calibration accuracy: Class 1
- Max. ram travel 60 mm approx.
- High stiffness and heavy weight 4 columns frame (german-style).
- Power supply: 230V 1ph 50Hz 750W
- Dimensions: 750x450x1500 mm approx.
- Weight: 1200...1250 kg



C089-08D + C127N + C111-13



C089-10A + C127N + C111-13

COMPRESSION 3000 kN High Stability

LOAD MEASURING SYSTEM

MODEL	Motorized	1 Gauge	2 Gauge	Digitec mod. C108N (p. 219)	Autotec mod. C098N (p. 219)
<b>C089-06</b>	▼	▼			
<b>C089-07</b>	▼		▼		
<b>C089-08D</b>	▼			▼	
<b>C089-10A *</b>	▼				▼

## COMPRESSION TESTING MACHINE TESTED FOR HIGH STABILITY **HIGH-END MODELS**

TO TEST CUBES UP TO 200 MM SIDE AND CYLINDERS UP TO Ø 160X320 MM

STANDARDS: EN 12390-4 | BS 1881:115 | DIN 51220 | ASTM C39 | NF P18-411 | AASHTO T22 | GOST 10180-2012

3000 KN CAPACITY



**CYBER-PLUS OR SERVO-PLUS EVOLUTION** DIGITAL TOUCH SCREEN DISPLAY



Cyber and Servo-Plus models have robust and reliable electronic controller, 5.7" touch screen color display. 2 USB ports, 1 SD port, 8 channels for pressure transducers (force measurement) or displacement transducers (Elastic Modulus and Poisson ratio measurement).

**INVERTER**

For a further improvement of energy efficiency and silent operation, (optional device code C099N).  
Technical details, p. 223



**BARCODE**

Scanner for specimen file/identification, (optional device code C099-01).  
Details, p. 223



C089-08N + C127N + C111-13



C089-10N + C104-04 + C121-07 + C111-13

COMPRESSION 3000 KN High Stability

LOAD MEASURING SYSTEM

MODEL	Motorized	Cyber-Plus Evolution mod. C109N (p. 224)	Servo-Plus Evolution mod. C104N (p. 224)
<b>C089-08N</b>	▼	▼	
<b>C089-10N *</b>	▼		▼

\* Servo-Plus/Autotec models feature fully automatic power pack - electrovalve operated test start (no manual lever).



**ACCESSORIES FOR 3000 kN MACHINES FROM MOD. C089-06 TO C089-10N**

**C111-32** DISTANCE PIECE, 20 mm high for cylinders Ø 150x300 mm

**C111-12** DISTANCE PIECE, 73+50 mm high for cubes 200 mm side

**C111-13** DISTANCE PIECES, 73+50+50 mm high for cubes 200 and 150 mm side

**C111-14** DISTANCE PIECES, 73+50+50+50 mm high for cubes 200, 150 and 100 mm side

**C111-15** DISTANCE PIECES, 50+50 mm high for cylinders Ø 110x220 mm

**C111-24** DISTANCE PIECE 50 mm high

**C111-25** DISTANCE PIECE 73 mm high

**C110-15** LOWER COMPRESSION PLATEN, Ø 216x40 mm, hardened and rectified to test cubes 100 and 150 mm, as an alternative to the standard platen Ø 278 mm  
 Technical details: see p. 319

 **Note:** the cylinders Ø 160x320 mm do not require any distance piece.



**C110-15**

**C127N** GRAPHIC PRINTER on thermo-paper on board for digital models

**C127-11** THERMO-PAPER roll for printer (pack of 10 rolls)

**C121-07** SAFETY GUARDS, polycarbonate, with hinges and lock, to CE Directive. See p. 317

**C121-51** STOP SWITCH on safety guard. See p. 317

**C107-10** CAPPING RETAINERS (set of two) for cylinders Ø 150 mm and 6". Other models: see p. 316

**C107-20** NEOPRENE PADS (set of two) for cylinders Ø 150 mm 60 shore A. Other models: see p. 316



**C107-10 + C107-20**

**C110-30** UPPER COMPRESSION PLATEN+SPHERICAL SEAT, to fix on the testing machine, in replacement of the standard platen + seat to obtain an increased vertical clearance of the testing chamber and to meet the ASTM C39, C1231 and AASHTO T22, T851  
 Platen dimensions: Ø 165x30 mm  
 Weight: 10 kg approx.  
 Technical details: see p. 316



**C110-30**

**C115-01** TWO WAY HYDRAULIC VALVE, connected to the motorized pumping unit of the machine to activate a second frame. Technical details: see p. 318



**C115-01**

**C097-01** DUAL LOW CAPACITY DIGITAL RANGE, complete with appropriate pressure transducer, only for digital machines. Recommended range 0-250kN.  
 Technical details: see p. 313



**C097-01**

**C097-05** CALIBRATION CLASS 1, starting from 1% of the full range. With a special calibration procedure it is possible to grant Class 1 practically on the full range of the compression machine. Applicable only on digital machines.

**C097-08** OFFICIAL ACCREDIA (Equivalent UKAS, ENAC, DAKKS, SAS, COFRAC etc.) HARDNESS CERTIFICATE of upper and lower compression platens. Minimum hardness: 55 HRC. See p. 313

**C107-01** AUTO-CENTERING DEVICE for cubes 100 and 150 mm side, and cylinders Ø 100 and 150 mm.  
 Technical details: see p. 316



**C107-01**

- C100** SPLITTING TENSILE test device for cylinders.  
EN 12390-6 | ASTM C496  
Technical details and other models: see p. 314

**C100**

- C103** SPLITTING TENSILE test device for self blocking pavers and cubes. EN 1338, 12390-6.  
Technical details: see p. 314

- C106** FLEXURAL TEST DEVICE for concrete beams.  
EN 12390-5 | ASTM C78, C293 | AASHTO T97  
Technical details: see p. 315

**C106**

- E170** COMPRESSION DEVICE to test cement specimens  
40.1x40 mm EN 196 | ASTM C349  
Technical details and other models: see p. 315

**E170**

- C104-10N** SERVO-STRAIN  
Servocontrolled Software, system of:  
- Load or Strength  
- Displacement  
- Strain  
This system can be used only with Servo-Plus Evolution machine mod. C089-10N. Technical details see p. 282

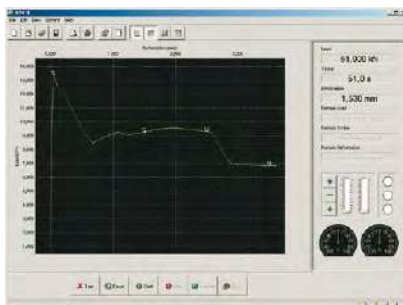
**C104-10N**

- C125N** ELASTIC MODULUS determination of the secant compression on concrete. Automatic system with pace rate control also when releasing the load, applicable only to high stability frames with Servo-Plus Evolution.  
EN 12390-13, 13412, 13286-43, UNI 6556, ASTM C469, ISO 6784, DIN 1048, BS 1888:121  
Technical details: see p. 284

- C126** BENCH to hold the compression machine. See p. 317

- C104-04** CONSOLE HOUSING THE SERVO-PLUS EVOLUTION  
The pump assembly **lined** with sound proofing material for noise reduction and the digital system are encased to enhance the design and look of the machine.  
Technical details: see p. 314

**C089-10N****C104-04**

- C099N** INVERTER DEVICE  
**NEW** Applicable only on Cyber-Plus and Servo-Plus Evolution machines.  
Technical details: see p. 223

**C104-06****C099N**

- C104-06** CONSOLE HOUSING THE CYBER-PLUS EVOLUTION  
**NEW** New console internally lined with sound proofing material, to reduce noise and allow for the inverter integration. Detail: see p. 223

#### SOFTWARE for DIGITEC / AUTOTEC or CYBER / SERVO PLUS models

<b>C109-10 (N)*</b>	SOFTWARE for compression tests
<b>C123 (N)*</b>	SOFTWARE <b>Servonet</b> for remote control through PC
<b>C109-11 (N)*</b>	SOFTWARE for flexural tests
<b>C109-12 (N)*</b>	SOFTWARE for splitting tensile

Technical detail: see p. 18

**(N)\*** for Cyber - Servo Plus models.

## COMPRESSION TESTING MACHINE 3000 KN CAPACITY TESTED FOR HIGH STABILITY

TO TEST BLOCKS MAX 500X300 MM, CUBES UP TO 200 MM SIDE AND CYLINDERS UP TO Ø 160X320 MM

STANDARDS: EN 12390-4, EN 772-1 | BS 1881:115, 6073 | DIN 51220 | NF P18-411 | ASTM C39, C140, C1314 | AASHTO T22 | GOST 10180-2012

### DIAL GAUGES MODELS

- Gauges Ø 250 mm with specific resistance scales for cubes 150 mm and cylinders Ø 150 - 160 mm
- Gauges divisions: 3000 kN div. 10 kN  
600 kN div. 2 kN

### MAIN FEATURES FOR ALL MODELS

- Max. vertical daylight to test blocks: 283 mm
- Horizontal daylight between columns: 340 mm
- Compression platens for blocks: 510x320x55 mm
- Max. vertical daylight to test cubes and cylinders: 334.5 mm
- Compression platens to test cubes, cylinders: Ø 287x60 mm
- Calibration accuracy: Class 1
- Max. ram travel 60 mm approx.
- High stiffness and heavy weight 4 columns frame (german-style).
- Power supply: 230V 1ph 50Hz 750W
- Dimensions: 750x520x1500 mm approx.
- Weight: 1350...1400 kg



C089-17D + C127N



C089-19A + C127N

COMPRESSION 3000 kN High Stability Blocks

LOAD MEASURIG SYSTEM

MODEL	Motorized	1 Gauge	2 Gauge	Digitec mod. C108N (p. 219)	Autotec mod. C098N (p. 219)
<b>C089-15</b>	▼	▼			
<b>C089-16</b>	▼		▼		
<b>C089-17D</b>	▼			▼	
<b>C089-19A *</b>	▼				▼

## COMPRESSION TESTING MACHINE TESTED FOR HIGH STABILITY **HIGH-END MODELS**

TO TEST BLOCKS MAX 500X300 MM, CUBES UP TO 200 MM SIDE AND CYLINDERS UP TO Ø 160X320 MM

STANDARDS: EN 12390-4, EN 772-1 | BS 1881:115, 6073 | DIN 51220 | NF P18-411 | ASTM C39, C140, C1314 | AASHTO T22 | GOST 10180-2012

# 3000 KN CAPACITY



**CYBER-PLUS OR SERVO-PLUS EVOLUTION** DIGITAL TOUCH SCREEN DISPLAY



Cyber and Servo-Plus models have robust and reliable electronic controller, 5.7" touch screen color display. 2 USB ports, 1 SD port, 8 channels for pressure transducers (force measurement) or displacement transducers (Elastic Modulus and Poisson ratio measurement).

**INVERTER**

For a further improvement of energy efficiency and silent operation, (optional device code C099N).  
Technical details, p. 223



**BARCODE**

Scanner for specimen file/identification, (optional device code C099-01).  
Details, p. 223



**C089-17N**



**C089-19N + C104-04 + C127N**

COMPRESSION 3000 KN High Stability Blocks

LOAD MEASURING SYSTEM

MODEL	Motorized	Cyber-Plus Evolution mod. C109N (p. 224)	Servo-Plus Evolution mod. C104N (p. 224)
<b>C089-17N</b>	▼	▼	
<b>C089-19N *</b>	▼		▼

\* Servo-Plus/Autotec models feature fully automatic power pack - electrovalve operated test start (no manual lever).

**ACCESSORIES FOR 3000 kN BLOCKS MACHINES FROM MOD. C089-15 TO C089-19N**

**C111-32** DISTANCE PIECE, 20 mm high for cylinders Ø 150x300 mm

**C111-12** DISTANCE PIECE, 73+50 mm high for cubes 200 mm side

**C111-13** DISTANCE PIECES, 73+50+50 mm high for cubes 200 and 150 mm side

**C111-14** DISTANCE PIECES 73+50+50+50 mm high for cubes 200, 150 and 100 mm side

**C111-15** DISTANCE PIECES 50+50 mm high for cylinders Ø 110x220 mm

**C111-24** DISTANCE PIECE 50 mm high

**C111-25** DISTANCE PIECE 73 mm high

 **Note:** The cylinders Ø 160x320 mm do not require any distance piece.

**C111-50** DISTANCE PIECE, it eliminates the heavy procedure to lift the lower rectangular platen and to add distance pieces. Technical details: see p. 320

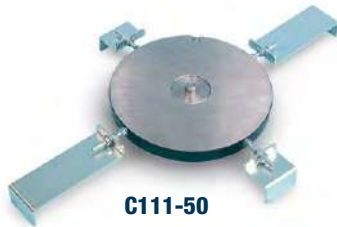

**C111-50**

AS AN ALTERNATIVE:

**C112-05** KIT of 4 HANDLES to lift the lower platen, making the positioning of distance pieces easier. Technical details: see p. 320



**C112-05**

**C117** SLIDING RAIL CARRIAGE, for an easy removal of the upper block platen, to perform tests on blocks or on standard cubes and cylinders.



**C117**

**C127N** GRAPHIC PRINTER on thermo-paper on board for digital models

**C127-11** THERMO-PAPER roll for printer (pack of 10 rolls)

**C121-08** SAFETY GUARDS, polycarbonate, with hinges and lock, to CE Directive. See p. 317

**C121-51** STOP SWITCH on safety guard. See p. 317

**C115-01** TWO WAY HYDRAULIC VALVE, connected to the motorized pumping unit of the machine to activate a second frame. Technical details: see p. 318



**C115-01**

**C097-05** CALIBRATION CLASS 1, starting from 1% of the full range. With a special calibration procedure it is possible to grant Class 1 practically on the full range of the compression machine. Applicable only on digital machines.

**C097-08** OFFICIAL ACCREDIA (Equivalent UKAS, ENAC, DAKKS, SAS, COFRAC etc.) HARDNESS CERTIFICATE of upper and lower compression platens. Minimum hardness: 55 HRC. See p. 313

**C097-01** DUAL LOW CAPACITY DIGITAL RANGE, complete with **appropriate pressure transducer**, only for digital machines. Recommended range 0-250kN. Technical details: see p. 313



**C097-01**

**C100** SPLITTING TENSILE test device for cylinders. EN 12390-6 | ASTM C496  
 Technical details and other models: see p. 314



**C100**

- C103** SPLITTING TENSILE test device for self blocking pavers and cubes. EN 1338, 12390-6.  
Technical details: see p. 314

AS AN ALTERNATIVE:

- C103-01** SPLITTING TENSILE test device for self blocking pavers and cubes having max. dimensions 300x500mm, directly fixed on the large compression platens. EN 1338, 12390-6.  
Technical details: see p. 314

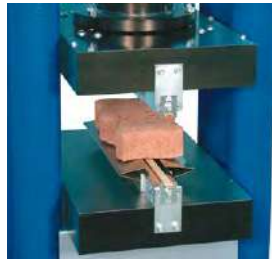

**C103-01**

- C106** FLEXURAL TEST DEVICE for concrete beams. EN 12390-5 | ASTM C78, C293 | AASHTO T97  
Technical details: see p. 315



**C106**

- E170** COMPRESSION DEVICE to test cement specimens 40.1x40 mm EN 196 | ASTM C349  
Technical details and other models: see p. 315



**E170**

- C104-10N** SERVO-STRAIN  
Servocontrolled Software, system of:  
- Load or Strength  
- Displacement  
- Strain

This system can be used only with Servo-Plus Evolution machine mod. C089-19N. Technical details see p. 282

- C125N** ELASTIC MODULUS determination of the secant compression on concrete. Automatic system with pace rate control also when releasing the load, applicable only to high stability frames with Servo-Plus Evolution. EN 12390-13, 13412, 13286-43, UNI 6556, ASTM C469, ISO 6784, DIN 1048, BS 1888:121  
Technical details: see p. 284

- C126** BENCH to hold the compression machine. See p. 317

- C104-04** CONSOLE HOUSING THE SERVO-PLUS EVOLUTION  
The pump assembly **lined** with sound proofing material for noise reduction and the digital system are encased to enhance the design and look of the machine.  
Technical details: see p. 314



**C089-19N**

**C104-04**

- C099N** INVERTER DEVICE  
**NEW** Applicable only on Cyber-Plus and Servo-Plus Evolution machines.  
Technical details: see p. 223



**C104-06**



**C099N**

- C104-06** CONSOLE HOUSING THE CYBER-PLUS EVOLUTION  
**NEW** New console internally lined with sound proofing material, to reduce noise and allow for the inverter integration. Detail: see p. 223

#### SOFTWARE for DIGITEC / AUTOTEC or CYBER / SERVO PLUS models

<b>C109-10 (N)*</b>	SOFTWARE for compression tests
<b>C123 (N)*</b>	SOFTWARE <b>Servonet</b> for remote control through PC
<b>C109-11 (N)*</b>	SOFTWARE for flexural tests
<b>C109-12 (N)*</b>	SOFTWARE for splitting tensile

Technical detail: see p. 18

**(N)\*** for Cyber - Servo Plus models.

**COMPRESSION TESTING MACHINE 4000 KN CAPACITY TESTED FOR HIGH STABILITY HIGH-END MODELS**  
TO TEST CUBES UP TO 200 MM SIDE AND CYLINDERS UP TO Ø 250X500 MM  
STANDARDS: EN 12390-4, EN 13503-2 | BS 1881:115, BS 812-110, 812-111 | DIN 51220 | NF P18-411 | ASTM C39 | AASHTO T22  
GOST 10180-2012 | API RP 19C

4000 KN CAPACITY

**MAIN FEATURES FOR ALL MODELS**

- Max. vertical daylight: 530 mm
- Horizontal daylight between columns: 340 mm
- Compression platens Ø 287x60 mm
- Calibration accuracy: Class 1
- Max. ram travel 60 mm approx.
- High stiffness and heavy weight 4 columns frame (german-style).
- Power supply (motorized models): 230V 1ph 50Hz 750W
- Dimensions: 850x600x1500 mm approx.
- Weight: 1800...1900 kg



**CYBER-PLUS OR SERVO-PLUS EVOLUTION**  
DIGITAL TOUCH SCREEN DISPLAY



Cyber and Servo-Plus models have robust and reliable electronic controller, 5.7" touch screen color display. 2 USB ports, 1 SD port, 8 channels for pressure transducers (force measurement) or displacement transducers (Elastic Modulus and Poisson ratio measurement).

**INVERTER**



For a further improvement of energy efficiency and silent operation, (optional device code C099N). Technical details, p. 223

**BARCODE**



Scanner for specimen file/identification, (optional device code C099-01). Details, p. 223



C088-11N + C121-04 + C121-51 + C086-10

C088-10N + C127N + C121-04 - C181-51 + C086-10

COMPRESSION 4000 kN capacity

**LOAD MEASURING SYSTEM**

MODEL	Motorized	Cyber-Plus Evolution mod. C109N (p. 224)	Servo-Plus Evolution mod. C104N (p. 224)
<b>C088-10N</b>	▼	▼	
<b>C088-11N *</b>	▼		▼

\* Servo-Plus model feature fully automatic power pack - electrovalve operated test start (no manual lever).

## ACCESSORIES FOR 4000 kN MACHINES

- C111-32** DISTANCE PIECE, 20 mm high for cylinders Ø 250x500 mm
- C111-12** DISTANCE PIECES, 73+50 mm high, vertical daylight 407 mm
- C111-13** DISTANCE PIECES, 73+50+50 mm, vertical daylight 357 mm
- C111-14** DISTANCE PIECES, 73+50+50+50 mm high for cylinders Ø 150x300 mm
- C111-15** DISTANCE PIECES, 50+50 mm high, vertical daylight 430 mm
- C111-24** DISTANCE PIECE 50 mm high
- C111-25** DISTANCE PIECE 73 mm high
- C110-15** LOWER COMPRESSION PLATEN, Ø 216x40 mm, hardened and rectified to test cubes 100 and 150 mm, as an alternative to the standard platen Ø 278 mm  
Technical details: see p. 319

 **Note:** Vertical daylight of the compression platens is 530 mm. The operator will have to buy the needed distance pieces to reduce the daylight between the compression platens to get the correct daylight of the specimen under test plus approx. 10 to 15 mm

- C112-11** UPPER+LOWER LARGE COMPRESSION PLATENS 320x510x55 mm to test **also** blocks. It is necessary to have also the sliding rail carriage mod. C117
- C117** SLIDING RAIL CARRIAGE, for an easy removal of the large block upper platen
- C127N** GRAPHIC PRINTER on thermo-paper on board
- C127-11** THERMO-PAPER roll for printer (pack of 10 rolls)
- C104-10N** SERVO-STRAIN  
Servocontrolled Software, system of:  
- Load or Strength  
- Displacement  
- Strain  
This system can be used only with Servo-Plus Evolution machine mod. C088-11N. Technical details see p. 282
- C125N** ELASTIC MODULUS determination of the secant compression on concrete. Automatic system with pace rate control also when releasing the load, applicable only to high stability frames with Servo-Plus Evolution.  
EN 12390-13, 13412, 13286-43, UNI 6556, ASTM C469, ISO 6784, DIN 1048, BS 1888:121  
Technical details: see p. 284

- C121-02** SAFETY GUARDS, polycarbonate, with hinges and lock, to CE Directive.
- C121-51** STOP SWITCH on safety guard. See p. 317
- C115-01** TWO WAY HYDRAULIC VALVE, connected to the motorized pumping unit of the machine to activate a second frame.  
Technical details: see p. 318



**C115-01**

- C097-01** DUAL LOW CAPACITY DIGITAL RANGE, complete with **appropriate pressure transducer**. Recommended range 0-250kN. Technical details: see p. 313



**C097-01**

- C097-08** OFFICIAL ACCREDIA (Equivalent UKAS, ENAC, DAKKS, SAS, COFRAC etc.) **HARDNESS CERTIFICATE** of upper and lower compression platens. Minimum hardness: 55 HRC. See p. 313
- C107-01** AUTO-CENTERING DEVICE for cubes 100 and 150 mm side, and cylinders Ø 100 and 150 mm.  
Technical details: see p. 316

- C103**  
SPLITTING TENSILE test device for self blocking pavers and cubes.  
EN 1338, 12390-6.  
Technical details: see p. 314



**C103**

- C106**  
FLEXURAL TEST DEVICE for concrete beams.  
EN 12390-5 | ASTM C78, C293 | AASHTO T97  
Technical details: see p. 315



**C106**

- E170**  
COMPRESSION DEVICE to test cement specimens 40.1x40 mm  
EN 196 | ASTM C349  
Technical details and other models: see p. 315

### **C099N** NEW

- INVERTER DEVICE  
Applicable only on Cyber-Plus and Servo-Plus Evolution machines.  
Technical details: see p. 223



**C099N**

### SOFTWARE for DIGITEC / AUTOTEC or CYBER / SERVO PLUS models

<b>C109-10 (N)*</b>	SOFTWARE for compression tests
<b>C123 (N)*</b>	SOFTWARE <b>Servonet</b> for remote control through PC
<b>C109-11 (N)*</b>	SOFTWARE for flexural tests
<b>C109-12 (N)*</b>	SOFTWARE for splitting tensile

Technical detail: see p. 18

**(N)\*** for Cyber - Servo Plus models.



## COMPRESSION TESTING MACHINES 3000 kN AND 5000 kN CAPACITY TESTED FOR HIGH STABILITY

THIS OVERSIZED ISOSTATIC HIGH STABILITY STIFFNESS FRAME FOR CENTRAL AND RESEARCH LABORATORIES TO TEST HIGH STRENGTH SPECIMENS, EXPLOSIVE SAMPLES, ROCK AND CERAMIC

HIGH-END MODELS

STANDARDS: EN 12390-4 | BS 1881:115 | DIN 51220 | NF P18-411 | GOST 10180-2012

3000/5000 kN CAPACITY

### MAIN FEATURES FOR ALL MODELS

- Compression platens Ø 316x60 mm
- Hydraulic pressure: 360 bar max.
- Max. vertical daylight: 411 mm
- Horizontal daylight between columns: 321 - 345 mm
- Max. ram travel: 100 mm
- High stiffness and heavy weight 4 columns frame: 0.3 mm at max. load (german-style).
- Safety guards to CE Directive ■ Class "1"
- Frame size 3000 kN: 725x710x1570 mm
- Frame size 5000 kN: 750x750x1700 mm
- Power supply: 230V 1ph 50Hz 750W
- Weight frame 3000 kN: 2500 kg / 5000 kN: 4000 kg



### CYBER-PLUS OR SERVO-PLUS EVOLUTION

DIGITAL TOUCH SCREEN DISPLAY



Cyber and Servo-Plus models have robust and reliable electronic controller, 5.7" touch screen color display. 2 USB ports, 1 SD port, 8 channels for pressure transducers (force measurement) or displacement transducers (Elastic Modulus and Poisson ratio measurement).

### INVERTER



For a further improvement of energy efficiency and silent operation, (optional device code C099N). Technical details, p. 223

### BARCODE

Scanner for specimen file/identification, (optional device code C099-01). Details, p. 223



C088-01N

C087N

COMPRESSION 3000/5000 kN High Stability

LOAD MEASURING SYSTEM

MODEL	Code	Motorized	Cyber-Plus Evolution mod. C109N (p. 224)	Servo-Plus Evolution mod. C104N (p. 224)
<b>3000 kN</b>	<b>C087N</b>	▼	▼	
<b>3000 kN</b>	<b>C087-01N</b>	▼		▼
<b>5000 kN</b>	<b>C088N</b>	▼	▼	
<b>5000 kN</b>	<b>C088-01N</b>	▼		▼

★ Servo-Plus model feature fully automatic power pack - electrovalve operated test start (no manual lever).

## ACCESSORIES FOR 3000 kN and 5000 kN MACHINES

**C087-11** DISTANCE PIECE, 50 mm high

**C087-12** DISTANCE PIECE, 25 mm high

**C087-15** DISTANCE PIECE, 100 mm high

### Note:

Vertical daylight of the compression platens is 411 mm. The operator will have to buy the needed distance pieces to reduce the daylight between the compression platens to get the correct daylight of the specimen under test plus approx. 10 to 15 mm



**C112-11**

### NEW

**C087-16** CLAMPING DEVICE for distance pieces. Strongly recommended for tests on high strength samples.

**C112-11** UPPER+LOWER LARGE COMPRESSION PLATENS 320x510x55 mm to test **also** blocks. It is necessary to have also the sliding rail carriage mod. C117

**C117** SLIDING RAIL CARRIAGE, for an easy removal of the large block upper platen

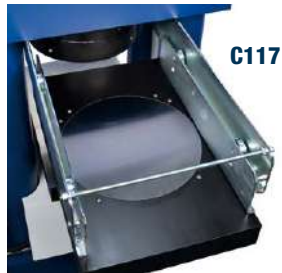

**C117**

**C127N** GRAPHIC PRINTER on thermo-paper on board

**C127-11** THERMO-PAPER roll for printer (pack of 10 rolls)

**C104-10N** SERVO-STRAIN  
Servocontrolled Software, system of:  
- Load or Strength  
- Displacement  
- Strain  
This system can be used only with Servo-Plus machines.  
Technical details: p. 282

**C125N** ELASTIC MODULUS determination of the secant compression on concrete. Automatic system with pace rate control also when releasing the load, applicable only to high stability frames with Servo-Plus Evolution.  
EN 12390-13, 13412, 13286-43, UNI 6556, ASTM C469, ISO 6784, DIN 1048, BS 1881:121  
Technical details: see p. 284

**C115-01** TWO WAY HYDRAULIC VALVE, connected to the motorized pumping unit of the machine to activate a second frame.  
Technical details: see p. 318



**C115-01**

**C097-01** DUAL LOW CAPACITY DIGITAL RANGE, complete with appropriate pressure transducer.  
Recommended range 0-250kN. Technical details: see p. 313



**C097-01**

**C097-05** CLASS 1, starting from 1% of the full range. With a special calibration procedure it is possible to grant Class 1 practically on the full range of the compression machine.

**C097-08** OFFICIAL ACCREDIA (Equivalent UKAS, ENAC, DAKKS, SAS, COFRAC etc.) HARDNESS CERTIFICATE of upper and lower compression platens. Minimum hardness: 55 HRC. See p. 313

**C100**  
SPLITTING TENSILE test device for cylinders. EN 12390-6 | ASTM C496  
Technical details and other models: see p. 314



**C100**

**C106**  
FLEXURAL TEST DEVICE for concrete beams.  
EN 12390-5 | ASTM C78, C293  
AASHTO T97  
Technical details: see p. 315



**C106**

**E170**  
COMPRESSION DEVICE to test portion of cement specimens 40.1x40 mm EN 196 | ASTM C349  
Technical details and other models: see p. 315

### NEW

**C099N** INVERTER DEVICE  
Applicable only on Cyber-Plus and Servo-Plus Evolution machines.  
Technical details: see p. 223



**C099N**

### SOFTWARE for DIGITEC / AUTOTEC or CYBER / SERVO PLUS models

<b>C109-10N</b>	SOFTWARE for compression tests
<b>C123N</b>	SOFTWARE <b>Servonet</b> for remote control through PC
<b>C109-11N</b>	SOFTWARE for flexural tests
<b>C109-12N</b>	SOFTWARE for splitting tensile

Technical detail: see p. 18

## SERVO-STRAIN

SOFTWARE-FIRMWARE for the automatic servo-controlled management of the testing machine to measure:

- LOAD OR STRENGTH
- DISPLACEMENT
- STRAIN

The **servo-strain** software/firmware can be applied **ONLY** to Matest **servo-plus evolution** testing machines.

The system is connected to displacement or strain transducers allowing to automatically perform the following tests:

- Deflection on fiber reinforced concrete beams (ASTM C1018, C1609 | EN 11039-03, 14487-1, 14488-3, 14651-05) see p. 305
- Punching of sprayed concrete plate with measurement of the absorbed energy (EN 10834, 14488-3, 14488-05) see p. 306
- Deformation and ductility on building materials, **with C104-10N**
- Lightweight Aggregates for concrete, mortar and grout (EN 13055-1 method 1) by using the suitable device mod. A081-01 described at p. 45
- Deflection on fiber reinforced concrete beams (ASTM C1018, C1609 | EN 11039-03, 14487-1, 14488-3, 14651-05) see p. 305
- Punching of sprayed concrete plate with measurement of the absorbed energy (EN 10834, 14488-3, 14488-05) see p. 306
- Research tests

The applied load is automatically controlled by the **servo-plus evolution** machine.

The displacement of the piston or the strain/deformation of the sample are controlled by the **servo-strain** software, through a linear strain gage transducer (accessory), calculating values such as deflection, energy absorption, ductility.

## TECHNICAL FEATURES

Same to **servo-plus evolution** model C104N (p. 224), and in addition:

- Real time Graphical/Numerical display of all test data (load, strain, displacement, energy absorption, deflection, ductility etc.)
- Printing of test results and certificate on the onboard printer, or on a laser printer (accessories) directly connected to the machine via USB port.
- Personalized management of the archive exportable through pendrive.
- Possibility to connect up to 3 test frames
- Eight analog channels to connect load cells or pressure transducers with strain gage technology, linear displacement/deformation transducers and with strain gage technology.

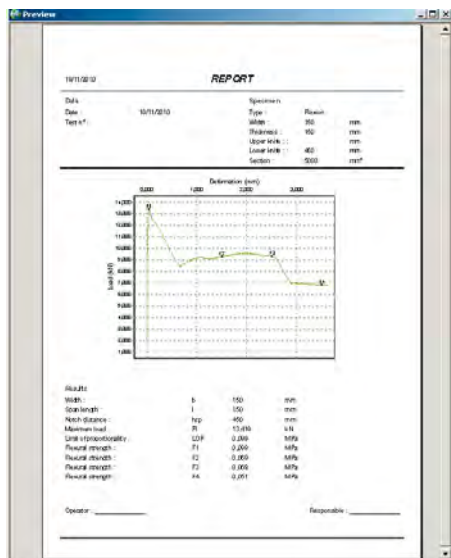

C104-10N Test report

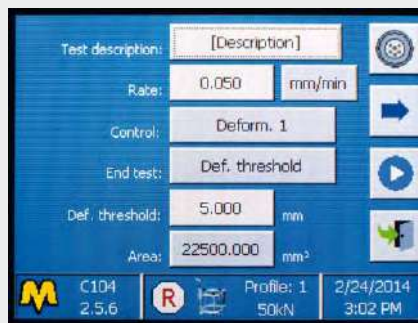

C104-10N  
Set up of customized compression test

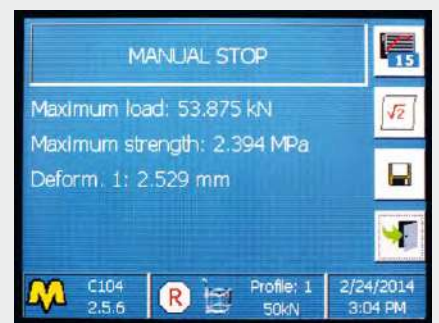

C104-10N  
Example of test result

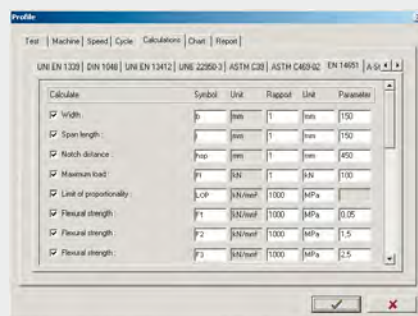

C109-15N Calculation set up

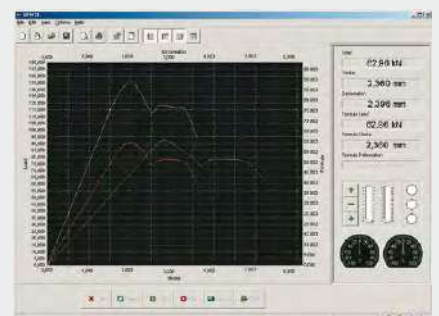

C104-10N Test graph

## SERVO-STRAIN APPLICATIONS

### C104-10N

#### STRAIN, DUCTILITY, POST-BREAKING BEHAVIOUR

##### LIGHTWEIGHT AGGREGATES FOR CONCRETE | EN 13055-1

Compression tests on concrete specimens, steel fiber reinforced concrete (FRC), building material, and for research and experimental tests in order to evaluate the behavior of a specimen subjected to compression stress.

#### NEEDED ACCESSORIES for High stability

##### Servo-Plus Evolution compression machines

### C104-31SP

SUPPORTING DEVICE for displacement transducer, able to grant an high precision and an high stability control of the test in mm/min.

### S336-14

LINEAR DISPLACEMENT TRANSDUCER, strain gage technology, 50 mm travel to permit a control between 0.2 mm/min and 2 mm/min  
Other models of linear displacement transducers at p. 549

**Note:** To permit a control lower than 0.2 mm/min. other transducers available on request.

#### NEEDED ACCESSORY

##### for all the other Servo-Plus Evolution machines

**C104-31** HOLDER for displacement transducer.

**S336-14** LINEAR DISPLACEMENT TRANSDUCER  
Strain gage technology, 50 mm travel.  
Other models of linear displacement transducers listed at p. 549

### C109-15N

#### DEFLECTION MEASUREMENT ON STEEL FIBER REINFORCED CONCRETE BEAMS

100x100x400(500) mm AND 150x150x500(600) mm

STANDARDS: EN 11039-03, 14487-1, 14488-3, 14651-05 | ASTM C1018, C1609

Used on a flexural frame machine complete with Servo-Plus Evolution (to be selected among the models C090-07N, C091-03N) and by adding the specific equipment required to perform the test, that is described and illustrated in detail at p. 295

#### PUNCHING TEST ON SPRAYED CONCRETE SPECIMENS WITH MEASUREMENTS OF THE ENERGY ABSORPTION

STANDARDS: EN 10834, 14488-3, 14488-05 | UNI 10834

Used on a flexural frame machine and a Servotronic model C090-07N, with the addition of the specific equipment required to perform the test, that is described and illustrated in detail at p. 295



**C090-14 + S336-14 + C109-15N**  
fixed on the flexural machine **C090-07N**



**C090-15 + C109-15N** fixed on the flexural machine **C090-07N**



**C089-10N + C104-10N**

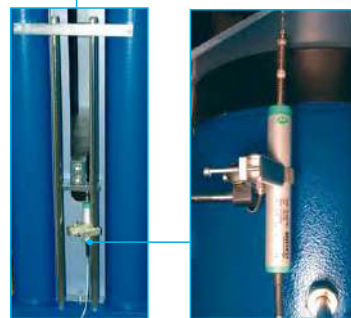

**S336-14 + C104-31SP**

**S336-14 + C104-31SP**  
Detail

**C109-15N**  
Test result



**C109-15N**  
Set up of deflection



**C125N**
**DETERMINATION OF THE SECANT COMPRESSION ELASTIC MODULUS ON CONCRETE**

AUTOMATIC WITH PACE RATE CONTROL ALSO WHEN RELEASING THE LOAD

STANDARDS: EN 12390-13, EN 13412, EN 13286-43 | ASTM C469 | ISO 6784 | UNI 6556 | DIN 1048 | BS 1888:121



It can be used with a MATEST high stability frame 2000 or 3000 or 5000 kN capacity, coupled to the automatic servo-controlled system "Servo-Plus Evolution" (mod. C104N) housed in a separate pyramidal frame.

The appliance includes:

**■ HYDRAULIC SYSTEM**

It is an hydraulic installation and has a high performance valve directly controlled by the digital unit that grants the automatic control of the pace rate increasing the load, keeps a certain load and then controls the pace rate decreasing the load.

The setting of the pace rate is made by a very sensitive valve controlled by a stepper motor thus allowing a micrometric action on the pace rate granting excellent results.

A laser position detector allows a rapid positioning of the piston. This grants a touching sensitivity of test starting at about 0.1 per thousand of the maximum capacity.

**■ ELECTRONIC MEASURING SYSTEM**

The high performance control and data processing unit controlled by a 32 bit microprocessor, can manage up to 8 high resolution channels for the control of load cells or transducers with strain gages bridge.

The unit contains two Analogical/Digital last generation converters with 24 bits resolution. The system processes the signals coming from the load cells and from the extensometers giving all the results required for further processing following the most updated International Standards for this application.

**■ DATA ACQUISITION AND PROCESSING UTM2 SOFTWARE LICENSE FOR ELASTIC MODULUS ON CONCRETE**

The software has been developed on the working line of the already known software UTM-2 (Windows menu). It contains the profiles of the main Standards used, but the user can modify as he likes and personalize the test profile that will be carried out in a completely automatic way by the testing machine.

The software allows to determine both the initial and stabilized **secant modulus of elasticity** as requested by **EN 12390-13** Standard. The software gives the possibility to print on a standard printer a test certificate reporting all the data concerning the test and the specimen and the graph of the test. The software includes the license "Servonet" mod. C123N, while the extensometers (two models are proposed: **A** and **B**) are not included in the standard supply and must be ordered separately (see accessories).

## ACCESSORY

### C125-01N

SOFTWARE FOR ELASTIC MODULUS TESTS ON ROCKS  
STANDARDS: ASTM D3148, D5407, D2664,  
EN 14580, EN 1926 | ISRM

**Note:** The Elastic Modulus on Concrete mod. C125N can be used together with:

A) EXTENSOMETERS (STRAIN GAGES), SINGLE USE, ELECTRIC, available in different sizes, mod. C125-10 to C125-13 (see accessories).

or:

B) EXTENSOMETERS /COMPRESSOMETERS, electronic, universal, mechanical frame, mod. C134 (see accessories)

AS AN ALTERNATIVE:

### B) C134

EXTENSOMETER / COMPRESSOMETER, ELECTRONIC, UNIVERSAL, MECHANICAL FRAME. It can be used only with samples having minimum height of 130 mm. Technical details: see p. 286



**C134**

### C134-10

TEMPLATE, to regulate and calibrate the base length of the C134 extensometer.

## ACCESSORIES

A) EXTENSOMETERS (STRAIN GAGES), SINGLE USE, ELECTRIC  
Pack of 10 pieces

Available models:

**C125-10** Electric extensometer, base length 10 mm

**C125-11** Electric extensometer, base length 20 mm

**C125-12** Electric extensometer, base length 30 mm

**C125-13** Electric extensometer, base length 60 mm

**C125-14** Electric extensometer, base length 120 mm

### C125-15

KIT for the application of single use extensometers composed by: glue, welder, solder, cleaning liquid, accessories, the whole in carrying case.

### C125-09

INTERFACE MODULE, a **needed accessory** to connect up to 4 electric single use extensometers. This module allows also the automatic calibration of the zero and of the measuring range after a special thermal compensation. This grants a five times better accuracy than the one requested by the Standards.



**C125-09**

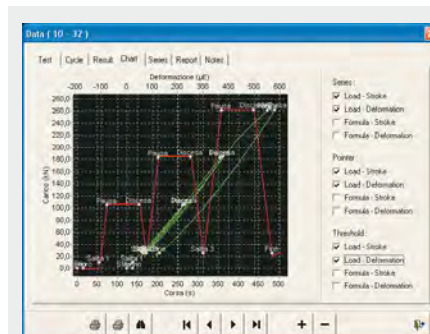

Screen during a test and marker indicating any change.

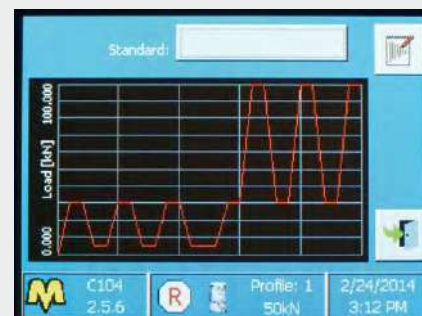

Test graph to EN 12390-13

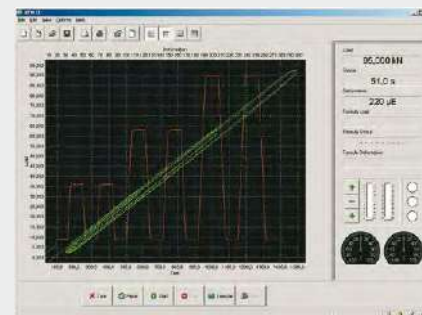

Test with longitudinal and transversal deformations

Test	Result	Unit	Value	Unit	
1	1	Base deformation 1	001	38.533	µE
1	2	Base deformation 2	002	45.9	µE
1	3	Base deformation 3	003	51.267	µE
1	4	Advanced deformation 1	011	173.433	µE
1	5	Advanced deformation 2	012	275.767	µE
1	6	Advanced deformation 3	013	382.467	µE
1	7	Base strength 1	001	1.142	N/mm²
1	8	Base strength 2	002	1.336	N/mm²
1	9	Base strength 3	003	1.162	N/mm²
1	10	Advanced strength 1	011	4.576	N/mm²
1	11	Advanced strength 2	012	8.075	N/mm²
1	12	Advanced strength 3	013	11.465	N/mm²
1	13	Compression module 1	E1	29001.164	N/mm²/E
1	14	Compression module 2	E2	29007.405	N/mm²/E
1	15	Compression module 3	E3	30205.376	N/mm²/E

Test data

## DETERMINATION OF THE SECANT COMPRESSION ELASTIC MODULUS TEST ON CONCRETE AND MORTAR SPECIMENS

### C134

#### ELECTRONIC UNIVERSAL EXTENSOMETER/COMPRESSOMETER

STANDARDS: EN 12390-14, EN 13412, EN 13286-43 | ASTM C469 | ISO 6784 | BS 1881:121 | DIN 1048 | UNI 6556

Made of two anodized aluminium pieces, one fixed and the other sliding and housing a displacement transducer that measures with high accuracy the movement of two conical points made of hardened steel and attached at the two ends of the electronic sensor. An aluminium template (optional mod C134-10) is used to regulate and to calibrate the base length.

The two conical points are coupled to the surface of the sample with a rapid and simple attachment system by means of two adjustable elastic straps.

The instrument is equipped with a mechanical knob to lock and unlock the displacement transducer, allowing to safeguard the selected base length while attaching of the device to the sample. Normally the test is performed on cylinders by using 3 extensometers/compressometers, and on cubes or beams by using 2 or 4 instruments.

The extensometer is suitable to test cubes, cylinders and beam specimens, having minimum height of 130 mm

It is also possible to test mortar prisms 40x40x160 mm by using a block for reducing length.

Gauge length adjustable from 50 to 160 mm

Feeding up to 10 V

Travel:  $\pm 1.5$  mm

Sensitivity less than 0.01 micron

Supplied complete with reducing block for mortar prisms, elastic straps, carrying case.

**Weight:** 1000 g approx.

#### ACCESSORIES

**C134-10** TEMPLATE, anodized aluminium made, used to regulate and calibrate the base length.

**S337-51** CALIBRATION PROCESS for one Extensometer/Compressometer combined with digital unit.

#### Note:

The Compressometers and the Compressometer/Extensometer connected to electronic linear transducers (accessory mod. S336-11) can be used with:

- Matest Servo-Plus Evolution compression machines equipped with Automatic Elastic Modulus system (mod. C125N) in complete accordance with EN, ASTM, ISO, DIN, BS, UNI Specifications (see p. 284)
- Matest Cyber-Plus and Servo-Plus compression machines. The electric cable of the displacement transducer is "directly" connected to one of the eight channels available on the digital unit.

Through the suitable Software (accessory mod. C130-05), the digital unit will automatically elaborate the data, supplying the load/deformation graph with certificate printing.



C134 with case

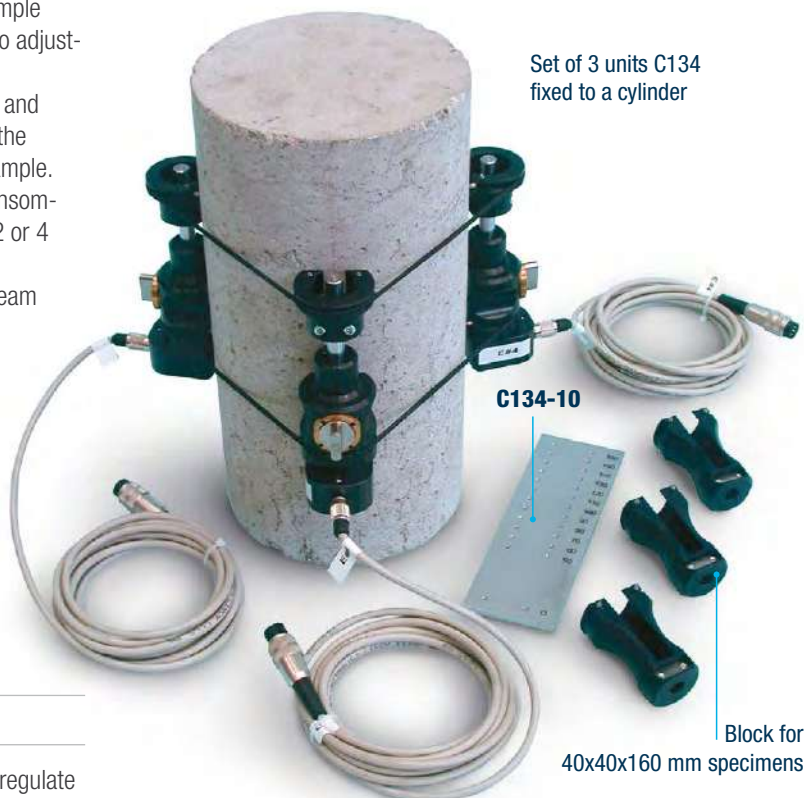

Set of 3 units C134 fixed to a cylinder

C134-10

Block for 40x40x160 mm specimens

#### C130-05

FIRMWARE for Elastic Modulus test on Concrete, Mortar, Rock specimens and tests according to API 19C and ISO 13503-2 Automatic data and processing acquisition, load/deformation graph and certificate printing with direct management of the testing machine. The software can be installed only on Cyber and Servo-Plus Evolution systems.



C130-05 Test execution

#### Note:

The Elastic Modulus test, to fully comply EN, ASTM, ISO, DIN, UNI, BS Standards, must be carried out with a Servo-Plus Matest machine equipped with C125N automatic system with pace rate load and "unload" control.

## STATIC ELASTIC MODULUS OF CONCRETE

### COMPRESSOMETER

Used to determine the strain and deformation characteristics of concrete specimens. It comprises two steel rings for clamping to the specimen, two gauge length bars, and spherically-seated lever unit. Supplied **without** dial gauge or strain transducer to be ordered separately (see accessories).



C132N + S375

C131N1 + S375

C130N + S375

#### AVAILABLE MODELS

- C130N** COMPRESSOMETER for cylinders Ø 150x300 mm; Ø 160x320 mm; Ø 6"x12"
- C131N1** COMPRESSOMETER for cylinders Ø 100x200 mm; Ø 112.8x220 mm; Ø 4"x8"
- C132N** COMPRESSOMETER for cubes 150 mm side.
- C132-01N** COMPRESSOMETER for cubes 200 mm side.

#### NEEDED ACCESSORY

- S375** DIAL GAUGE, 5 mm travel by 0.001 mm subd.

AS AN ALTERNATIVE:

- S336-11** ELECTRONIC LINEAR DISPLACEMENT TRANSDUCER, 10 mm travel, complete with cable.  
Technical details: see p. 549

#### Note:

The Compressometers and the Compressometer/Extensometer connected to electronic linear transducers (accessory mod. S336-11) can be used with:

- Matest Servo-Plus Evolution compression machines equipped with Automatic Elastic Modulus system (mod. C125N) in complete accordance with ASTM C469, ISO 6784, UNI 6556 Specifications (see p. 284 )
- Matest Cyber-Plus and Servo-Plus compression machines. The electric cable of the displacement transducer is "directly" connected to one of the eight channels available on the digital unit. Through the suitable Software (accessory mod. C130-05), the digital unit will automatically elaborate the data, supplying the load/deformation graphic with certificate printing.

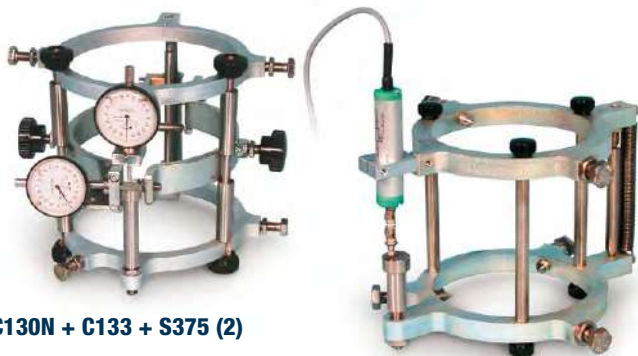

C130N + C133 + S375 (2)

C130N + S336-11

#### C133

#### COMPRESSOMETER-EXTENSOMETER Ø 150-160 mm

STANDARD: ASTM C469

To measure both axial deformation and diametrical extension of cylinder specimens Ø 150x300 mm, 160x320 mm, 6"x 12" under compression stress, by determining the elastic modulus.

It consists of a central ring for the diametrical extension measure, to be fixed on the C130N compressometer.

Supplied **without** dial gauges or linear strain transducers (**two required**) to be ordered separately (see accessories).

#### C133-01

#### COMPRESSOMETER

#### EXTENSOMETER Ø 100-112.8 mm

Same as mod. C133 but, connected to C131N1. It is suitable to test cylinders from Ø 100x200 to 112.8x220 mm.

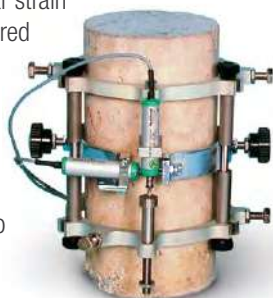

C130N + C133 + S336-11(2)

- C130-05** SOFTWARE for Elastic Modulus test on Concrete Mortar specimens and tests according to API 19C and ISO 13503-2

Automatic data and processing acquisition, load/deformation graphic and certificate printing with direct management of the testing machine. The software can be used only with Cyber and Servo-Plus Evolution systems.

- S337-51** CALIBRATION PROCESS of one displacement transducer S336-11 combined with Cyber or Servo-Plus Matest compression machine.

#### Note:

The Elastic Modulus test, to fully comply EN, ASTM, ISO, DIN, UNI, BS Standards, must be carried out with a Servo-Plus Matest machine equipped with C125N automatic system with pace rate load and "unload" control.



## FLEXURE TESTING MACHINES

### MAIN FEATURES

- Motorized or hand operated models.
- Gauge load measuring system.
- **Digitec** or **Cyber-Plus Evolution** graphic display unit.
- **Autotec** or **Servo-Plus Evolution** servo-controlled automatic system.
- Stand-alone frame, or combined to another frame.
- Possibility of two-point loading or centre-point loading by simply removing one upper roller and placing the other in the centre.
- Graduated scales to get easy rollers adjustment.
- Rollers are hardened, case hardened and rectified.

WE PROPOSE VARIOUS FLEXURAL FRAMES:

- **C090** Series with frame 150 kN capacity frame to perform flexural tests on concrete beam specimens having max. dimensions of 150x150x750 mm. See p. 290



**C090 SERIE**

- **C091** Series with **open sided frame** 150 kN capacity to perform flexural tests on concrete beam specimens having max. dimensions of 200x200x800 mm;
  - Flat blocks (max. width 600 mm);
  - Flagstones and Kerbs;
  - Any type of beam having max. size 600xh250 mm (lower rollers max. length 1325 mm). See p. 292



**C091 SERIE**

- **C090-06** Series with 200 kN capacity, high stiffness flexure frame to perform tests on concrete beams max. dimensions 150x150x750 mm;
  - Flat blocks, max. width 600 mm
  - Flagstones and Kerbs
  - Any type of beam having max. width 600 mm and max. height 150 mm
  - Energy absorption on sprayed concrete samples
 See p. 294



**C090-06 SERIE**

**C095N**  
**FLEXURAL AND TRANSVERSE MULTIPURPOSE TESTING MACHINE**  
 320 KN CAPACITY, **C-SHAPED OPEN FRAME**



To perform a wide range of flexural/compression tests on concrete specimens, paving slabs, kerbs, mortar specimens, flexural toughness of steel FRC concrete, energy absorption of sprayed concrete, beam deflection and toughness of steel FRC/Shotcrete, measurement of crack opening (CTOD-CMOD) etc. See p. 296

**C096N**  
**HIGH STIFFNESS FLEXURAL MACHINE**  
 360 KN CAPACITY.  
 See p. 300



**C096N**



**C095N**

- C093** Series to perform flexural tests on concrete beam specimens having max. dimensions 200x200x800 mm and to perform tests on any kind of other product with max. dimensions 550x550 mm (adjustable distance between lower rollers up to max. 1325 mm). See p. 308



**C093 SERIE**

- C109-09N + C093-05N**  
 CONCRETE PIPE TESTING MACHINE, 1000 kN capacity to test pipes  $\varnothing$  450 to 2600 mm. See p. 307

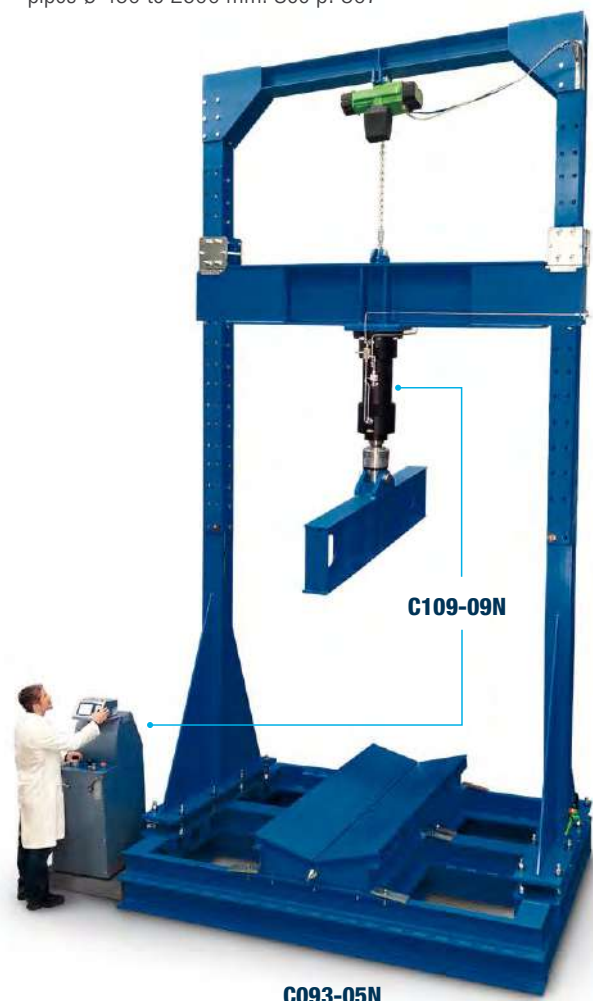

**C109-09N**

**C093-05N**

## FLEXURAL TESTING MACHINE 150 KN CAPACITY

FOR FLEXURAL TESTS ON CONCRETE BEAM SPECIMENS MAX. DIMENSIONS 150X150X600 (750) MM

STANDARDS: EN 12390-5 | ASTM C78, C293 | AASHTO T97 | BS 1881:118

# 150 KN CAPACITY

### MAIN FEATURES

- Max. vertical daylight between upper/lower rollers: 160 mm
- Rollers dimensions: Ø 40x160 mm
- Complete with 4 adjustable and articulated rollers.
- Distance of lower rollers adjustable from 100 to 455 mm
- Distance of upper rollers adjustable from 40 to 155 mm
- Gauge diameter 250 mm with 0.5 kN divisions.
- Max. ram travel 50 mm approx.
- Calibration accuracy: class 1.0
- Hydraulic device to stop the piston stroke at its max excursion, to avoid pumping the piston out of the cylinder.
- Power supply (motorized models): 230V 1ph 50Hz 750W
- Dimensions: 540x460x960 mm
- Weight: 180...240 kg approx.

### INVERTER

Details, p. 223



C090-03N + C104-04 + C127N

C090-02D

C090-01 + C111-16

FLEXURAL 150 kN capacity

#### LOAD MEASURING SYSTEM

MODEL	Hand Operated	Motorized	1 Gauge	Cyber-Plus Evolution mod. C109N (p.224)	Servo-Plus Evolution mod. C104N (p.224)	Digitec mod. C108N (p.219)	Autotec mod. C098N (p.219)
<b>C090</b>	▼		▼				
<b>C090-01</b>		▼	▼				
<b>C090-02N</b>		▼		▼			
<b>C090-03N</b>		▼			▼		
<b>C090-02D</b>		▼				▼	
<b>C090-03A</b>		▼					▼

## ACCESSORIES FOR 150 kN FLEXURAL MACHINES

**C111-16** DISTANCE PIECE, 50 mm high to test beams 100x100x400/500 mm

**C127N** GRAPHIC PRINTER on thermo-paper on board for digital models

**C115-01** TWO WAY HYDRAULIC VALVE, connected to the motorized pumping unit of the machine to activate a second frame. Technical details: see p. 318



**C115-01**

**C104-04** CONSOLE HOUSING THE SERVO-PLUS EVOLUTION, the pump assembly is lined with sound-proofing material for noise reduction and encased to enhance the design of the machine. See p. 314



**C104-04**

**C097-01** DUAL LOW CAPACITY DIGITAL RANGE, complete with **appropriate pressure transducer**, only for digital machines. Range selectable from 10 kN to 100 kN. Technical details: see p. 313



**C097-01**

**C097-05** CALIBRATION CLASS 1, starting from 1% of the full range. With a special calibration procedure it is possible to grant Class 1 practically on the full range of the flexural machine. Applicable only on digital machines.

**C100** SPLITTING TENSILE test device for cylinders. EN 12390-6 | ASTM C496  
Technical details and other models: see p. 314



**C100**

**E170** COMPRESSION DEVICE to test mortar specimens 40.1x40 mm EN 196 | ASTM C349  
Technical details and other models: see p. 315



**E170**

**E172-01** FLEXURE DEVICE for mortar prisms 40.1x40x160 mm. EN 196 / EN ISO 679 (it can be used only with the dual low capacity digital range 0-15kN).  
Technical details and other models: see p. 428



**E172-01**

**C126** BENCH to hold the compression machine. See p. 317



**C126**

**C099N**  NEW

INVERTER DEVICE  
Applicable only on Cyber-Plus and Servo-Plus Evolution machines.  
Technical details: see p. 223



**C099N**

### SOFTWARE for DIGITEC / AUTOTEC or CYBER / SERVO PLUS models

<b>C109-16 (N)*</b>	SOFTWARE for flexural tests on clay blocks
<b>C109-11 (N)*</b>	SOFTWARE for flexural tests
<b>C109-12 (N)*</b>	SOFTWARE for splitting tensile

Technical detail: see p. 18

**(N)\*** for Cyber - Servo Plus models.

## FLEXURAL TESTING MACHINE 150KN CAPACITY OPEN-SIDED FRAME

FOR FLEXURAL TESTS ON CONCRETE BEAM SPECIMENS MAX. DIMENSIONS 200X200X800 MM, FLAT BLOCKS, FLAGSTONES, KERBS, TILES, SLABS, MASONRY UNITS, AND ANY TYPE OF MATERIAL HAVING MAX. SIZE 600X250 MM (LOWER ROLLERS MAX. DISTANCE 1325 MM)

STANDARDS: EN 12390-5 | EN 1340:4 | ASTM C78, C293 | AASHTO T97 | BS1881 :118, BS 6073-1, BS 7263

# 150 KN CAPACITY

### MAIN FEATURES

- **Open-sided frame** for an easy and fast positioning of the specimen between the rollers
- Max. vertical daylight between upper/lower rollers: 260 mm, intermediate daylight positions: 210, 160, 110 and 60 mm
- Roller dimensions: Ø 40x613 mm
- Ram travel 110mm approx.
- Calibration accuracy: class 1.0
- Simple action piston with counterweights to minimize frictions
- Power supply: 230V 1ph 50Hz 750W
- Dimensions: 1400x1200x1430 mm
- Weight: 350 kg approx.

**INVERTER**

Details, p. 223

**BARCODE**

Details, p. 223

**C091-03N + C091-11 + PC**

FLEXURAL 150 kN capacity

**LOAD MEASURING SYSTEM**

MODEL	Motorized	Cyber-Plus Evolution mod. C109N (p. 224)	Servo-Plus Evolution mod. C104N (p. 224)	Digitec mod. C108N (p. 219)	Autotec mod. C098N (p. 219)
<b>C091-02N</b>	▼	▼			
<b>C091-03N</b>	▼		▼		
<b>C091-02D</b>	▼			▼	
<b>C091-03A</b>	▼				▼

## ACCESSORIES FOR FLEXURAL 150 kN "OPEN SIDED FRAME"

- C091-10** ROLLERS GROUP: lower adjustable from 75 to 525 mm, and **only one** upper central roller for single point method.
- C091-11** ROLLERS GROUP: lower adjustable from 75 to 525 mm, and upper adjustable from 75 to 180 mm for two points method.
- C091-12** ROLLERS GROUP: lower adjustable from 75 to 1325 mm, and upper adjustable from 75 to 575 mm for two points method.
- C091-14** ROLLERS GROUP: lower adjustable from 75 to 1325 mm, and **only one** upper central roller for single point method.



- C091-13** UPPER TAMPER (steel made), for concrete KERBS tests. The tamper is mounted on a rotating coupling and fixed to the upper part of the machine to apply a flexural strength on three points on the kerb, without any torsional stress. STANDARD: EN 1340

- C090-15** DEFLECTION MEASUREMENT TEST on fiber reinforced concrete beams 100x100x400(500) mm and 150x150x500(600) mm  
STANDARDS: EN 14488-3 | ASTM C1609, C1018  
The test is performed with the specific equipment (deflection measurement device, displacement transducers) described at pag. 305 and the automatic servocontrolled system of load and displacement Servo-Strain (see p. 282)



C090-15



C093-11

- C093-11** DEVICE for flexural tests on clay blocks for flooring. STANDARDS: EN 15037-2, 15037-3 | UNI 9730-3
- C127N** GRAPHIC PRINTER on thermo-paper on board for digital models
- C127-11** THERMO-PAPER roll for printer (pack of 10 rolls)

- C115-01** TWO WAY HYDRAULIC VALVE, connected to the motorized pumping unit of the machine to activate a second frame. Technical details: see p. 318



C115-01

- C097-01** DUAL LOW CAPACITY DIGITAL RANGE, complete with **appropriate pressure transducer**, only for digital machines. Range selectable from 10 kN to 100 kN. Technical details: see p. 313



C097-01

- C097-05** CALIBRATION CLASS 1, starting from 1% of the full range. With a special calibration procedure it is possible to grant Class 1 practically on the full range of the flexural machine. Applicable only on digital machines.

- C100** SPLITTING TENSILE test device for cylinders. EN 12390-6 | ASTM C496  
Technical details and other models: see p. 314



- C103** SPLITTING TENSILE test device for self blocking pavers and cubes. EN 1338, 12390-6. Technical details: see p. 314



C100

C103

AS AN ALTERNATIVE:

- C103-02** SPLITTING TENSILE test device for self blocking pavers and cubes, max dimensions 300x500 mm. EN 1338, 12390-6. Technical details: see p. 314

- E170** COMPRESSION DEVICE to test mortar specimens 40.1x40 mm EN 196 | ASTM C349  
Technical details and other models: see p. 315

- E172-01** FLEXURE DEVICE for mortar prisms 40.1x40x160 mm EN 196 / EN 1015 (it can be used only with the dual low capacity digital range 0-15kN). Technical details and other models: see p. 428

### C099N NEW

INVERTER DEVICE  
Applicable only on Cyber-Plus and Servo-Plus Evolution machines.  
Technical details: see p. 223



C099N

### SOFTWARE for DIGITEC / AUTOTEC or CYBER / SERVO PLUS models

- |                     |  |
|---------------------|--|
| <b>C109-15 (N)*</b> | SOFTWARE for deflection measurement test               |
| <b>C109-16 (N)*</b> | SOFTWARE for flexural tests on clay blocks             |
| <b>C123 (N)*</b>    | SOFTWARE <b>Servonet</b> for remote control through PC |
| <b>C109-11 (N)*</b> | SOFTWARE for flexural tests                            |
| <b>C109-12 (N)*</b> | SOFTWARE for splitting tensile                         |

Technical detail: see p. 18

(N)\* for Cyber - Servo Plus models.

**FLEXURAL FRAME, 200 KN CAPACITY HIGH STIFFNESS AND STABILITY**

FOR FLEXURAL TESTS ON CONCRETE BEAMS MAX. DIMENSIONS 150X150X600/750 MM, FLAT BLOCKS, FLAGSTONES, KERBS, TILES, SLABS, MASONRY UNITS, AND ANY TYPE OF MATERIAL HAVING MAX. WIDTH 600 MM AND MAX. HEIGHT 150 MM

STANDARDS: EN 12390-5 | EN 1340:4 | BS 1881:118, 6073-1, 7263 | ASTM C78, C293 | AASHTO T97

200 KN CAPACITY

**MAIN FEATURES**

- High stiffness frame with minimum deflection at maximum load (0.9 mm)
- Max. vertical daylight between upper/lower rollers: 160 mm
- Ram travel: 110 mm, to get minimum daylight of 50 mm
- Horizontal daylight of the testing chamber: 720 mm
- Simple action piston with counterweights to maximize frictions
- Power supply: 230V 1ph 50Hz 750W
- Dimensions: 990x970x1105 mm
- Weight: 190...250 kg approx.

**INVERTER**

For a further improvement of energy efficiency and silent operation, (optional device code C099N).  
 Technical details, p. 223

**BARCODE**

Scanner for specimen file/identification, (optional device code C099-01).  
 Details, p. 223



THE FRAME IS SUPPLIED **WITHOUT** UPPER/LOWER ROLLERS GROUP, TAMPER, BASE SUPPORT ETC. TO BE ORDERED SEPARATELY (see accessories).



C090-07N + C090-13



C090-07N + C127N + C104-04 + C090-13

FLEXURAL 200 kN capacity High Stiffness

**LOAD MEASURING SYSTEM**

MODEL	Capacity kN	Cyber-Plus Evolution mod. C109N (p. 224)	Servo-Plus Evolution mod. C104N (p. 224)	Digitec mod. C108N (p. 219)	Autotec mod. C098N (p. 219)
<b>C090-06N</b>	200	▼			
<b>C090-07N</b>	200		▼		
<b>C090-06D</b>	200			▼	
<b>C090-07A</b>	200				▼

## ACCESSORIES FOR FLEXURAL 200 KN HIGH STIFFNESS

**Rollers**, Ø 40 mm, hardened and rectified, cadmium plated against corrosion.

Lower rollers have adjustable distance from 75 to 900 mm, and upper rollers have adjustable distance from 75 to 180 mm for two points loading tests.

Possibility to easily place in the centre one upper roller for centre point loading tests.

Models:

**C090-12** ROLLERS GROUP upper and lower, 160 mm long.

**C090-13** ROLLERS GROUP upper and lower, 613 mm long.

### ACCESSORY FOR C090-13

**C090-21** ROLLERS-HOLDERS (lowers only) 613 mm long, to be installed on the C090-13 group in order to modify the max. vertical daylight at 60 mm and min. at -50 mm to test tiles, slabs etc. with max. thickness of 50 mm and flexibility up to -45 mm

**C090-14** ENERGY ABSORPTION TEST on sprayed concrete specimens. STANDARDS: EN 14488-5 | UNI 10834

The test is performed with the specific equipment (square base with useful size of 500x500 mm, loading element, displacement transducer) described at p. 283 and the Software/Firmware automatic system of load and displacement Servo Strain (p. 282)



**C090-14**

**C090-15** DEFLECTION MEASUREMENT TEST on fiber reinforced concrete beams 100x100x400(500) mm and 150x150x500(600) mm STANDARDS: EN 14488-3 ASTM C1609, C1018

The test is performed with the specific equipment (deflection measurement device, displacement transducers) described at p. 305 and the Software/Firmware automatic system of load and displacement Servo Strain (p. 282)



**C090-15**

**C111-17** DISTANCE PIECE 40 mm high, needed to perform the deflection test to EN 14488-3

**C091-13** UPPER TAMPER (steel made), for concrete KERBS tests. The tamper is mounted on a rotating coupling and fixed to the upper part of the machine to apply a flexural strength on three points on the kerb, without any torsional stress. STANDARD: EN 1340



**C091-13**

**C093-11** DEVICE for flexural tests on clay blocks for flooring. STANDARDS: EN 15037 | UNI 9730-3

**C127N** GRAPHIC PRINTER on thermo-paper on board for digital models

**C097-01** DUAL LOW CAPACITY DIGITAL RANGE, complete with appropriate pressure transducer.

Range selectable from 10 kN to 100 kN. Technical details: see p. 313



**C093-11**



**C097-01**

**C097-05** CALIBRATION CLASS 1, starting from 1% of the full range. With a special calibration procedure it is possible to grant Class 1 practically on the full range of the flexural machine.

**C100** SPLITTING TENSILE test device for cylinders. EN 12390-6 | ASTM C496 Technical details and other models: see p. 314



**C100**

**C103** SPLITTING TENSILE test device for self blocking pavers and cubes. EN 1338, 12390-6. Technical details: see p. 314



**C103**

As alternative:

**C103-02** SPLITTING TENSILE TEST DEVICE for self blocking pavers and cubes, max. dimensions 300x500 mm EN 1338, 12390-6 Technical details: see p. 314

**E170** COMPRESSION DEVICE to test mortar specimens 40.1x40 mm EN 196 | ASTM C349 Technical details and other models: see p. 315



**C103-02**

### SOFTWARE for DIGITEC / AUTOTEC or CYBER / SERVO PLUS models

<b>C109-15 (N)*</b>	SOFTWARE for deflection measurement test
<b>C109-16 (N)*</b>	SOFTWARE for flexural tests on clay blocks
<b>C123 (N)*</b>	SOFTWARE <b>Servonet</b> for remote control through PC
<b>C109-11 (N)*</b>	SOFTWARE for flexural tests
<b>C109-12 (N)*</b>	SOFTWARE for splitting tensile

Technical detail: see p. 18

**(N)\*** for Cyber - Servo Plus models.



C095N

**FLEXURAL AND TRANSVERSE MULTIPURPOSE TESTING MACHINE, 320 KN CAPACITY**
**C-SHAPED OPEN FRAME**

 STANDARDS: EN 12390-5, 12390-6, 14488-5, 1338, 1339, 1340, 196  
 ASTM C78, C293, C1550, C496, C349 | UNI 9730-3

320 KN CAPACITY

**MAIN FEATURES**

- Servo-Plus evolution 8-channel servo controlled system for a fully automatic execution of the test (mod. C104N).
- Load is measured by a high accuracy electric strain cell, eliminating the piston's weight and friction.
- C-shaped open frame for an easy and fast positioning of the specimen between the rollers.
- Frame is closed by a hydraulic vertical rod, granting high rigidity.
- Ram travel: 110 mm
- Maximum vertical daylight between upper/lower rollers: 263 mm
- Horizontal clearance (between uprights): 1040 mm
- Possibility to easily place one upper roller in the centre for centre-point loading.
- Graduated scales are foreseen for easy roller adjustment.
- Simple action piston with counterweights to minimize frictions.
- Calibration accuracy: class 1
- Power supply: 230V 1ph 50Hz 750W
- Frame dimensions: 1700x1470x1557 mm
- Frame weight: 800 kg + 100 kg approx. of control console.

**INVERTER**

For a further improvement of energy efficiency and silent operation, (optional device code C099N). Technical details, p. 223

**BARCODE**

Scanner for specimen file/identification, (optional device code C099-01). Details, p. 223



C095N with accessories

## C095N SPECIFIC APPLICATIONS



### C095N-11 FLEXURAL TESTS ON CONCRETE BEAMS

STANDARDS: EN 12390-5 | ASTM C78, C293

Upper and lower roller group for third point and centre tests on concrete beams up to 200x200x800 mm

Rollers size: 30 mm Ø by 312 mm long, cadmium plated against corrosion.

Span between upper rollers adjustable from 75 to 570 mm

Span between lower rollers adjustable from 75 to 1560 mm

**Weight:** 65 kg approx.

#### NEEDED ACCESSORY

**C095N-18** FOUR DISTANCE PIECES height 43 mm each, to adjust the vertical useful light of the frame from 263 to 177 mm (67 mm with piston excursion)



### C095N-12 FLEXURAL TESTS ON PAVING SLABS AND ANY TYPE OF MATERIAL HAVING MAX. WIDTH 600 MM

STANDARD: EN 1339

One upper centre loading roller and two lower roller assembly for tests on paving slabs.

Rollers size: 40 mm Ø by 620 mm long, cadmium plated against corrosion.

Span between lower rollers adjustable from 75 to 1560 mm

**Weight:** 76 kg approx.



#### NEEDED ACCESSORY

**C095N-18** FOUR DISTANCE PIECES height 43 mm each, to adjust the vertical useful light of the frame from 263 to 177 mm (67 mm with piston excursion)

### C095N-19 FLEXURAL TESTS ON CONCRETE BEAMS

STANDARDS: EN 12390-5

Two upper loading rollers for third point and centre tests on concrete beams up to 200x200x800 mm

Rollers size: 40 mm Ø by 312 mm long, cadmium plated against corrosion, to be used with the rollers assembly C095N-12.

Span between upper rollers adjustable from 75 to 570 mm

**Weight:** 65 kg approx.

#### NEEDED ACCESSORY

**C095N-18** FOUR DISTANCE PIECES height 43 mm each, to adjust the vertical useful light of the frame from 263 to 177 mm (67 mm with piston excursion)

### C095N-13 UPPER TAMPER FOR TESTING KERBS

STANDARDS: EN 1340

The Tamper, steel made, is mounted on a rotating coupling and fixed to the upper part of the machine to apply a flexural load on the kerb, without any torsional stress.

To be used with the rollers assembly C095N-12.

The vertical useful light is 221 mm (111 mm with piston excursion).

**Weight:** 6 kg approx.

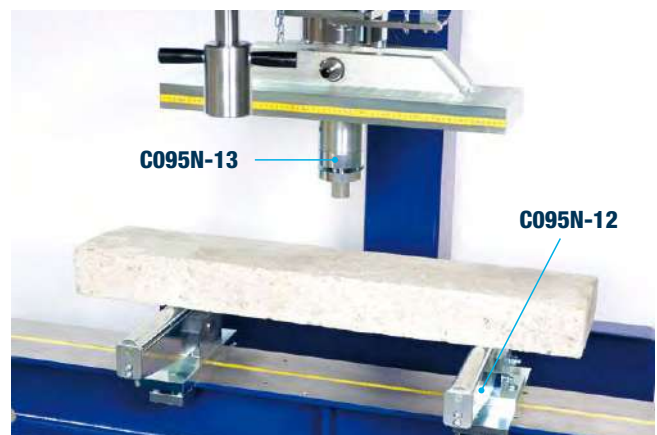

#### ACCESSORY

**C095N-18** FOUR DISTANCE PIECES height 43 mm each, to adjust the vertical useful light from 221 to 135 mm (25 mm with piston excursion)

## C095N SPECIFIC APPLICATIONS

### C095N-14 COMPRESSION TESTS UP TO 320KN CAPACITY

The multipurpose (flexural) frame can be equipped with Lower platen and Upper spherically seated platen, having  $\varnothing$  165 mm by 30 mm thick, to perform compression tests on low strength and small size specimens.

To be used with the four distance pieces C095N-18

The vertical useful light is from 350 to 178 mm (68mm with piston excursion).

The device can be used also for compression tests on mortar specimens (by using suitable devices E170 etc. listed on page 315, splitting tensile tests (by using suitable C100, C103 etc. devices listed on page 314).

**Weight:**

20 kg approx.



**C095N-14 / C095N-18**

### C095N-15

DISPLACEMENT TRANSDUCER, to measure the piston travel.  
Supplied complete with holder to the test frame.

Travel: 100 mm

Full bridge at 350 Ohm

Independent linearity: < 0.1%

Standard sensitivity: 2 mV/V

### C095N-16 ENERGY ABSORPTION TEST ON SPRAYED CONCRETE SLABS

STANDARD: EN 14488-5

SQUARE BASE SUPPORT FRAME useful inside dimensions 500x500 mm, holding the sprayed concrete slab, complete with spherically upper loading element.

**Weight:**

125 kg approx.



**C095N-16 + S336-14 with sample**

#### NEEDED ACCESSORY

**S336-14** DISPLACEMENT TRANSDUCER, to measure the central deformation of the slab under concentrated load.  
Travel: 50 mm  
Full bridge at 350 Ohm  
Independent linearity: < 0.1%  
Standard sensitivity: 2 mV/V

### C109-15N

FIRMWARE / SOFTWARE for:

- Measurement of deflection on fibre reinforced concrete beams
- Determination of toughness, first crack strength and ductility
- Energy absorption test on sprayed specimens.

STANDARD: EN 14488-5

(see p. 283)

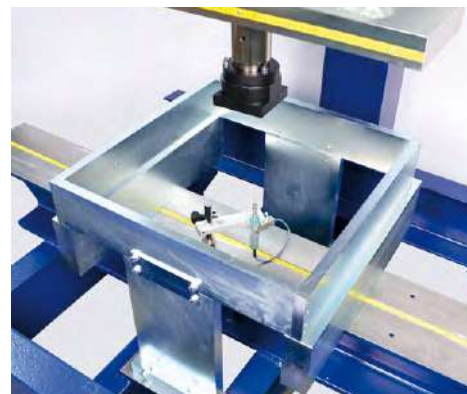

**C095N-16 / S336-14 without sample**

### C095N-17 FLEXURAL TOUGHNESS OF FIBRE REINFORCED CONCRETE (FCR) SLABS

STANDARD: ASTM C1550

BASE SUPPORT FRAME, holding the concrete slabs having 800 mm diameter by 75 mm thick, complete with upper loading element.

Weight: 60 kg approx.

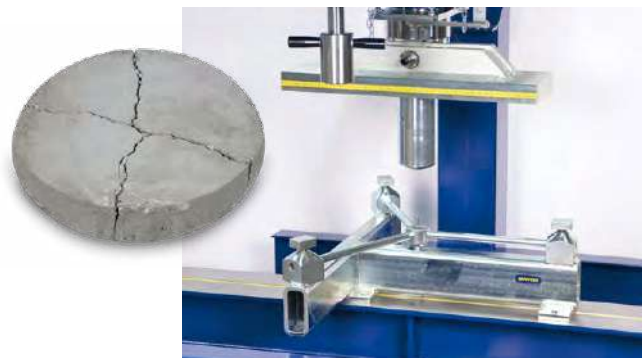

**C095N-17**

#### NEEDED ACCESSORY

**S336-14** DISPLACEMENT TRANSDUCER, to measure the central deformation of the slab under concentrated load.  
Travel: 50 mm  
Full bridge at 350 Ohm  
Independent linearity: < 0.1%  
Standard sensitivity: 2 mV/V

### C109-15N

FIRMWARE / SOFTWARE for:

- Measurement of deflection on fibre reinforced concrete beams
- Determination of toughness, first crack strength and ductility
- Energy absorption test on sprayed specimens.

STANDARD: EN 14488-5 | ASTM C1550

(see p. 283)

## C095N SPECIFIC APPLICATIONS

**C090-15** DEFLECTION MEASUREMENT TEST on fiber reinforced concrete beams 100x100x400(500) mm and 150x150x500(600) mm  
STANDARDS: EN 14488-3 ASTM C1609, C1018  
The test is performed with the specific equipment (deflection measurement device, displacement transducers) described at p. 305 and the Software/Firmware automatic system of load and displacement Servo Strain (p. 282)



**C090-15**

**C127N** GRAPHIC PRINTER on thermo-paper on board

**C115-01** TWO-WAY HYDRAULIC VALVE, connected to the motorized pumping unit of the machine to activate a second frame. Technical details: see p. 318



**C115-01**

**C097-05** CALIBRATION CLASS 1, starting from 1% of the full range. With a special calibration procedure it is possible to grant Class 1 practically on the full range of the flexural machine.

**C100** SPLITTING TENSILE test device for cylinders.  
EN 12390-6 | ASTM C496  
Technical details and other models: see p. 314



**C100**

**C103** SPLITTING TENSILE test device for self blocking pavers and cubes. EN 1338, 12390-6  
Technical details: see p. 314



**C103**

AS AN ALTERNATIVE:

**C103-02** SPLITTING TENSILE test device for self blocking pavers and cubes, max dimensions 300x500 mm.  
EN 1338, 12390-6. Technical details: see p. 314



**C103-02**

**C093-11** DEVICE for flexural tests on clay blocks for flooring.  
STANDARD: UNI 9730-3



**C093-11**

**E170** COMPRESSION DEVICE to test mortar specimens 40.1 x 40 mm EN 196 | ASTM C349  
Technical details and other models: see p. 315



**E170**

### SOFTWARE for CYBER models

<b>C109-16N</b>	SOFTWARE for flexural tests on clay blocks
<b>C123N</b>	SOFTWARE <b>Servonet</b> for remote control through PC
<b>C109-11N</b>	SOFTWARE for flexural tests

Technical detail: see p. 18

#### Note:

Accessories for specific applications listed above are common for different tests. We recommend to check them when ordering, to avoid duplications.

**C096N**  
**HIGH STIFFNESS FLEXURAL MACHINE, 360 KN CAPACITY**

STANDARDS: EN 12390-5, 1339, 1340, 14488-5 | ASTM C78, C293, C1550



360 KN CAPACITY

The frame has been designed to perform different kind of tests, from the simple third/centre point flexural test on beams to the advanced FRC displacement controlled tests and energy absorption tests on sprayed concrete. Accurate results are granted by the high stiffness of the frame according to the international Standards requirement (more than 200 kN/mm) and by a high precision load cell measurement system fitted into the frame. The high horizontal daylight of the testing chamber allows to test big dimension specimens. **Rollers are optional and must be ordered separately** according to user needs.

**MAIN FEATURES**

- 1 mm deformation every 200 kN.
- Easy positioning of the specimen.
- High precision load cell.
- Possibility to test any type of specimen: beams, flagstones, blocks, kerbs, FRC, slabs.
- Graduated scales for an easy rollers adjustment.
- Piston travel limit device.
- Simple action piston with counterweights.
- Power supply: 230V 1ph 50Hz 750W.

**INVERTER**

For a further improvement of energy efficiency and silent operation, (optional device code C099N). Technical details, p. 223

**C096N + C095N-12**

## C096N SPECIFIC APPLICATIONS



## TECHNICAL SPECIFICATIONS

Model		C096N
Load capacity		360 kN
Load reading		Load cell
Horizontal daylight of the testing chamber		980 mm
Max. vertical daylight between upper/lower rollers	With C095N-11	263 mm
	With C095N-12	253 mm
	With C095N-13	221 mm
	With C095N-19	253 mm
	With C095N-14	350 mm
Upper rollers adjustable distance		From 75 to 210 mm
Lower rollers adjustable distance		From 75 to 850 mm
Ram travel		140 mm
Dimensions		600x1240x1400 mm
Weight (approx.)		900 kg

### C095N-11 FLEXURAL TESTS ON CONCRETE BEAMS

STANDARDS: EN 12390-5 | ASTM C78, C293

Upper and lower roller group for third point and centre tests on concrete beams up to 200x200x800 mm

Rollers size:  
30 mm Ø by 312 mm long, cadmium plated against corrosion.

**Weight:** 65 kg approx.



### C095N-19 FLEXURAL TESTS ON CONCRETE BEAMS

STANDARDS: EN 12390-5

Two upper loading rollers for third point and centre tests on concrete beams up to 200x200x800 mm

Rollers size: 40 mm Ø by 312 mm long, cadmium plated against corrosion, to be used with the rollers assembly C095N-12.

**Weight:** 65 kg approx.

#### NEEDED ACCESSORY

**C095N-18** FOUR DISTANCE PIECES height 43 mm each, to adjust the vertical useful light of the frame.

#### NEEDED ACCESSORY

**C095N-18** FOUR DISTANCE PIECES height 43 mm each, to adjust the vertical useful light of the frame.

### C095N-12 FLEXURAL TESTS ON PAVING SLABS AND ANY TYPE OF MATERIAL HAVING MAX. WIDTH 600 MM

STANDARD: EN 1339

One upper centre loading roller and two lower roller assembly for tests on paving slabs.

Rollers size:  
40 mm Ø by 620 mm long, cadmium plated against corrosion.

**Weight:** 76 kg approx.



### C095N-13 UPPER TAMPER FOR TESTING KERBS

STANDARDS: EN 1340

The Tamper, steel made, is mounted on a rotating coupling and fixed to the upper part of the machine to apply a flexural load on the kerb, without any torsional stress.

To be used with the rollers assembly C095N-12.

**Weight:** 6 kg approx.

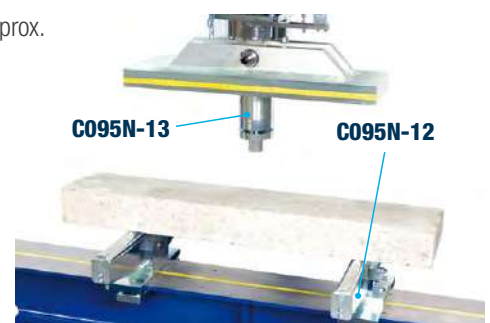

#### NEEDED ACCESSORY

**C095N-18** FOUR DISTANCE PIECES height 43 mm each, to adjust the vertical useful light of the frame.

#### ACCESSORY

**C095N-18** FOUR DISTANCE PIECES height 43 mm each, to adjust the vertical useful light from 221 to 135 mm (25 mm with piston excursion)

## C096N SPECIFIC APPLICATIONS

### C095N-14 COMPRESSION TESTS UP TO 320KN CAPACITY

The multipurpose (flexural) frame can be equipped with Lower platen and Upper spherically seated platen, having  $\varnothing$  165 mm by 30 mm thick, to perform compression tests on low strength and small size specimens.

To be used with the four distance pieces C095N-18.

The device can be used also for compression tests on mortar specimens (by using suitable devices E170 etc. listed on page 315, splitting tensile tests (by using suitable C100, C103 etc. devices listed on page 314).

**Weight:** 20 kg approx.



**C095N-14 / C095N-18**

### C095N-15

DISPLACEMENT TRANSDUCER, to measure the piston travel.  
Supplied complete with holder to the test frame.

Travel: 100 mm

Full bridge at 350 Ohm

Independent linearity: < 0.1%

Standard sensitivity: 2 mV/V

### C095N-17 FLEXURAL TOUGHNESS OF FIBRE REINFORCED CONCRETE (FCR) SLABS

STANDARD: ASTM C1550

BASE SUPPORT FRAME, holding the concrete slabs having 800 mm diameter by 75 mm thick, complete with upper loading element.

Weight: 60 kg approx.



**C095N-17**

#### NEEDED ACCESSORY

**S336-14** DISPLACEMENT TRANSDUCER, to measure the central deformation of the slab under concentrated load.  
Travel: 50 mm  
Full bridge at 350 Ohm  
Independent linearity: < 0.1%  
Standard sensitivity: 2 mV/V



**C096N + C095N-17**

### C090-14SP ENERGY ABSORPTION TEST ON SPRAYED CONCRETE SLABS

STANDARD: EN 14488-5

SQUARE BASE SUPPORT FRAME, holding the sprayed concrete slab with useful inside dimensions 500x500 mm, complete with spherically upper loading element.

**Weight:** 125 kg approx.



**C090-14SP + S336-14 with sample**

#### NEEDED ACCESSORY

**S336-14** DISPLACEMENT TRANSDUCER, to measure the central deformation of the slab under concentrated load.  
Travel: 50 mm  
Full bridge at 350 Ohm  
Independent linearity: < 0.1%  
Standard sensitivity: 2 mV/V

## C096N SPECIFIC APPLICATIONS

### C090-15

#### DEFLECTION MEASUREMENT DEVICE

STANDARDS: EN 14488-3 | ASTM C1609, C1018

This device is fixed directly on the fiber reinforced concrete beam under test.

The device is placed between the loading bearers of a flexure frame or of a flexure device in a compression frame.

The test is performed by applying a flexural load to the concrete beam with load and displacement control and with automatic deflection measurement of the loaded specimen.

It is possible to test fibre reinforced concrete beams 100x100x400 or 500 mm and 150x150x500 or 600 mm dimensions.

The deflection device is steel made with chromed finishing; it is supplied complete with transducer holders, vertically positioned on the two opposite sides of the beam, but without the two transducers, for the measurement of deflection (mod. S336-11), and without the fork form transducer (mod. C090-16) to be ordered separately.

**Dimensions:** 300x450x300 mm

**Weight:** 8 kg approx.



**C090-15**  
Bending device for testing  
to ASTM C1609

### S336-11

#### DISPLACEMENT TRANSDUCER, HIGH PRECISION

STANDARDS: EN 14488-3 | ASTM C1609, C1018

To be attached to the device C090-15 for the measurement of deflection and determination of toughness on fibre reinforced concrete beams. Travel: 10 mm

Complete with cable and connector.

Two transducers are required.

### C109-15N

#### FIRMWARE/SOFTWARE for:

- Measurement of deflection on fibre reinforced concrete beams.
- Determination of toughness, first crack strength and ductility.
- Energy absorption test on sprayed specimens. (see p. 283)

STANDARD: EN 14488-5

### C109-14N

**FIRMWARE/SOFTWARE** for flexural strengths (first peak, ultimate and residual) EN 14488-3 (see p. 18).



**C090-18**

**C090-20**

### C090-16

#### FORK FORM TRANSDUCER

STANDARDS: EN 11039-2, EN 14651

For the measurement of the Crack Mouth Opening Displacement (CMOD) and the Crack Base, Medium and Tip Opening Displacement (CTOD). Measuring range: 5 mm

Complete with cable and connector.



EN 14651 Clip gauge device

### C090-18

**DATUM BLOCK**, to be glued on the lower side of the concrete beam for the first crack strength test (CMOD). Pack of 24 pieces.

### C090-20

**DATUM BLOCK**, square, to be glued on the concrete beam surface for the deflection measurement on the two opposite sides (CTOD). Pack of 24 pieces.



## FIBER REINFORCED CONCRETE AND SHOTCRETE

In order to improve concrete performance in the plastic state, macrofibers are added to the concrete mix to increase the post-crack bending strength. This process improves the capacity of the material to absorb energy after cracking (toughness property). There are basically two test methods of the American Society of Materials Testing (ASTM) for evaluating the toughness of fiber-reinforced concrete:

**ASTM C1609 for beams and ASTM C1550 for round panels.** The European Committee for Standardization (CEN) proposes the method **EN 14651 for beam specimens and EN 14488-5 for square panels.**

### Fibers-Reinforced Concrete Beam Specimens

The test evaluates the mechanical bending properties derived from the FRC in terms of area under the curve. This provides an indication of the **energy absorption capacity** (better known as **toughness**) of the beam and its magnitude depends directly on the geometric characteristics of the beam itself, with consideration of the applied load. The flexural test result can be represented by the load-deflection curve and index according to C1609; Or between the load and crack opening (CMOD, Crack Mouth Opening Displacement) of a notched beam, according to EN 14651.

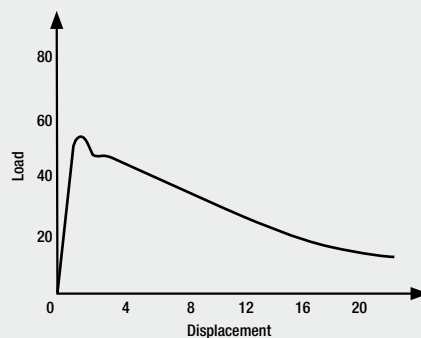

Load – Displacement curve according to EN 14651

### Fibers-Reinforced Concrete and Shotcrete Panel Specimens

Since real structures are characterized by a high degree of hyperstaticity, whereby the redistribution of the stresses generates larger areas of fracture and therefore more energy absorbed, specimens with larger fracture areas can be required (such as large beams or panels).

The toughness is evaluated through the records of the load-displacement curve, where the load is monitored until a preset value is achieved. With the flexural test on square panels according to EN 14488-5, the concrete specimen rests on a rigid square frame and is loaded through a square steel block; In this case the sample is subjected to a previously set displacement level.

Accordingly to the above, toughness can be specified as the energy absorbed for a given displacement.

On the other hand, the ASTM C1550 proposes a circular panel, better known as "Round Determinate Panel (RDP)".

In this reference test, the sample rests on symmetrical steel ball pivots (120°), resulting in a statically determined scheme.

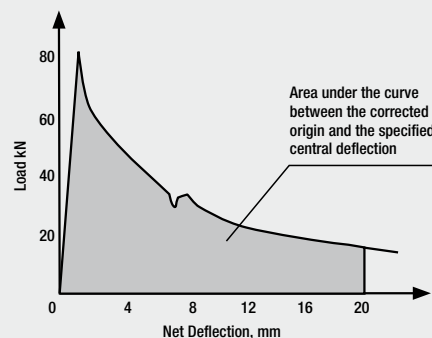

Test on RDP and Load-deflection curve according to ASTM C1550

As the loading process develops, the strain is recorded in the center of the panel, so as it is possible to plot the load-deflection curve, which area is subsequently integrated, to obtain the energy- deflection curve.

## I MEASUREMENT OF DEFLECTION ON FIBRE REINFORCED CONCRETE BEAMS 100X100X400(500) MM AND 150X150X500(600) MM DURING FLEXURE TEST.

STANDARDS: EN 14488-3 | ASTM C1609, C1018

## I DETERMINATION OF TOUGHNESS, FIRST CRACK STRENGTH (CRACK OPENING) AND DUCTILITY OF FIBRE REINFORCED CONCRETE. STANDARDS: EN 11039-2, EN 14651

## I FLEXURAL STRENGTHS (FIRST PEAK, ULTIMATE AND RESIDUAL) OF FIBRE REINFORCED BEAM SPECIMENS.

STANDARD: EN 14488-3

The equipment can be used **only** with the Servo-Plus Evolution machines.

Connected to the **Servo-Strain** Software/Firmware mod. C109-15N (see p. 283) for the automatic management of load and displacement.

It is necessary to contact Matest representative for the appropriate machine selection according to the FRC application.

The equipment consists of:

### C090-15

#### DEFLECTION MEASUREMENT DEVICE

STANDARDS: EN 14488-3 | ASTM C1609, C1018

This device is fixed directly on the fiber reinforced concrete beam under test. The device is placed between the loading bearers of a flexure frame or of a flexure device in a compression frame.

The test is performed by applying a flexural load to the concrete beam with load and displacement control and with automatic deflection measurement of the loaded specimen.

It is possible to test fibre reinforced concrete beams 100x100x400 or 500 mm and 150x150x500 or 600 mm dimensions.

The deflection device is made with chromed finishing; it is supplied complete with transducer holders, vertically positioned on the two opposite sides of the beam, but **without** the two transducers, for the measurement of deflection (mod. S336-11), and **without** the fork form transducer (mod. C090-16) to be ordered separately.

**Dimensions:** 300x450x300 mm

**Weight:** 8 kg approx.

### S336-11

#### DISPLACEMENT TRANSDUCER, HIGH PRECISION

STANDARDS: EN 14488-3 | ASTM C1609, C1018

To be attached to the device C090-15 for the measurement of deflection and determination of toughness on fibre reinforced concrete beams. Travel: 10 mm

Complete with cable and connector.

Two transducers are required.

### C109-15N

#### FIRMWARE/SOFTWARE for:

- Measurement of deflection on fibre reinforced concrete beams.
- Determination of toughness, first crack strength and ductility.
- Energy absorption test on sprayed specimens. (see p. 18)

### C109-14N

**FIRMWARE/SOFTWARE** for flexural strengths (first peak, ultimate and residual) EN 14488-3 (see p. 18).



**C090-15**  
Bending device for testing to ASTM C1609

### C090-20

**DATUM BLOCK**, square, to be glued on the concrete beam surface for the deflection measurement on the two opposite sides (CTOD). Pack of 24 pieces.

### C090-16

#### FORK FORM TRANSDUCER

STANDARDS: EN 11039-2, EN 14651

For the measurement of the Crack Mouth Opening Displacement (CMOD) and the Crack Base, Medium and Tip Opening Displacement (CTOD). Measuring range: 5 mm  
Complete with cable and connector.

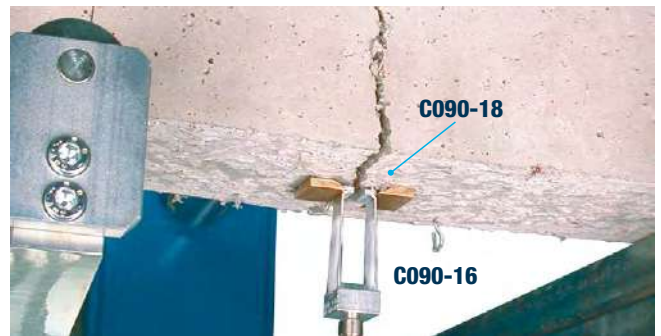

EN 14651 Clip gauge device

**C090-18 DATUM BLOCK**, to be glued on the lower side of the concrete beam for the first crack strength test (CMOD). Pack of 24 pieces.



**C090-07N + C090-13 + C109-15N + C090-15 + S336-11**  
Servo-controlled machine

## ENERGY ABSORPTION TEST ON SPRAYED CONCRETE SPECIMENS

STANDARDS: EN 14488-05 | UNI 10834

The equipment can be used **only** with the flexure Servo-Plus Evolution testing machine mod:

**C090-07N** Flexure **high stiffness** 200 kN capacity

**C095N** Flexure **multipurpose** 320 kN capacity

**C096N** Flexure **polyframe** 360 kN capacity.

Connected to the automatic servocontrolled system of load and displacement **Servo-Strain** mod C109-15N (see p. 283)

The equipment consists of:

### C109-15N

#### FIRMWARE/SOFTWARE for:

- Measurement of deflection on fibre reinforced concrete beams.
- Determination of toughness, first crack strength and ductility.
- Energy absorption test on sprayed specimens.

(see p. 18)



### C090-07N + C109-15N + C090-14 + S336-14 + C090-19 + C104-04

Test on square panels according to EN 14488-5



**C109-15N** Test result

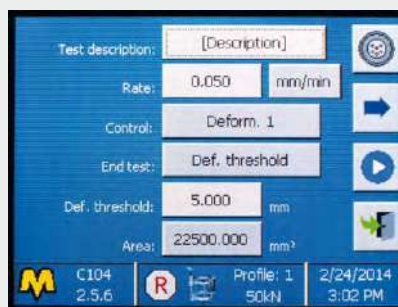

**C109-15N** Set up of deflection

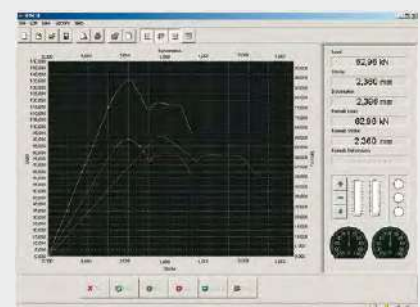

**C109-15N** Test graph

Software for real time test plot and result determination

### C090-14 SQUARE BASE FRAME

Dimensions 500x500 mm, complete with upper loading element, for energy absorption tests on sprayed concrete specimens.

### C090-19 HOLDER FOR TRANSDUCER

To be fixed to the high stiffness frame with square base.

### S336-14 DISPLACEMENT TRANSDUCER, HIGH PRECISION

To be fixed to the high stiffness frame equipped with the square base.

Travel: 50 mm

Full bridge at 350 Ohm

Independent linearity: < 0.1%

Standard sensitivity: 2 mV/V

## CONCRETE PIPE TESTING MACHINE

Designed and manufactured to test concrete sewer and drain pipes used in drainage works, water and irrigation supply systems etc.  
STANDARD: EN 1916 comparable to ASTM C301, C497 | BS 5911 | DIN 4035

The machine is composed of two parts:

- Electro-Hydraulic loading and control system
- Testing frame, steel made

### C109-09N ELECTRO-HYDRAULIC LOADING AND CONTROL SYSTEM, 1000 KN CAPACITY

- Double action alloy steel ram + cylinder.
- Ram travel: 400 mm
- The ram is ground.
- Upper attachment for steel frame cross-beam coupling.
- Spherical seat fixed to the ram for an uniform loading.
- Hydro-Plus Evolution loading and control cabinet, complete with hydraulic multipiston power pack group, maximum pressure safety valve, decompression valve, oil flow control valve granting smooth and accurate load pace.
- Computerized graphic display **Cyber-Plus Evolution** unit mod. C109N (technical details: see p. 224) with software for the acquisition, visualization, processing, printing and saving of the test data and certificates.
- Electric load cell 1000 kN capacity, for accurate load measurement directly from the ram.
- Two flexible high pressure hoses, to connect the cylinder to the hydraulic power pack.

**Power supply:** 230V 1ph 50Hz 1000W

**Dimensions:** 500 x 530 xh 1300 mm

**Weight:** 150 kg approx.

### C093-05N TESTING FRAME, STEEL MADE

- Pipe max. diameter (external): 2600 mm
- Pipe min. diameter (external): 450 mm
- Pipe max. length: 2500 mm
- Lower bearers: 2500 mm long
- Upper crossbeam: 2500 mm long
- Frame of structural steel, bolted together with high strength bolts, so it can be easily assembled/disassembled for delivery or for site displacements. The frame has to be locked to a concrete base to be prepared by the customer.
- Two upper crossbeams, raised and lowered by a motor two speed operated winch. The upper frame crossbeam is locked in position by pins inserted through the columns.
- Two lower bearers supporting the pipe to be tested. The bearers are supplied both flat and "V" shaped as requested by the EN 1916 Spec.
- Upper loading beam, floating on a seat.

**Power supply of the winch:** 230/400V 3ph 50Hz 2000W

**Frame dimensions:** 3700x2500x6900 mm approx.

**Weight:** 7000 kg approx.

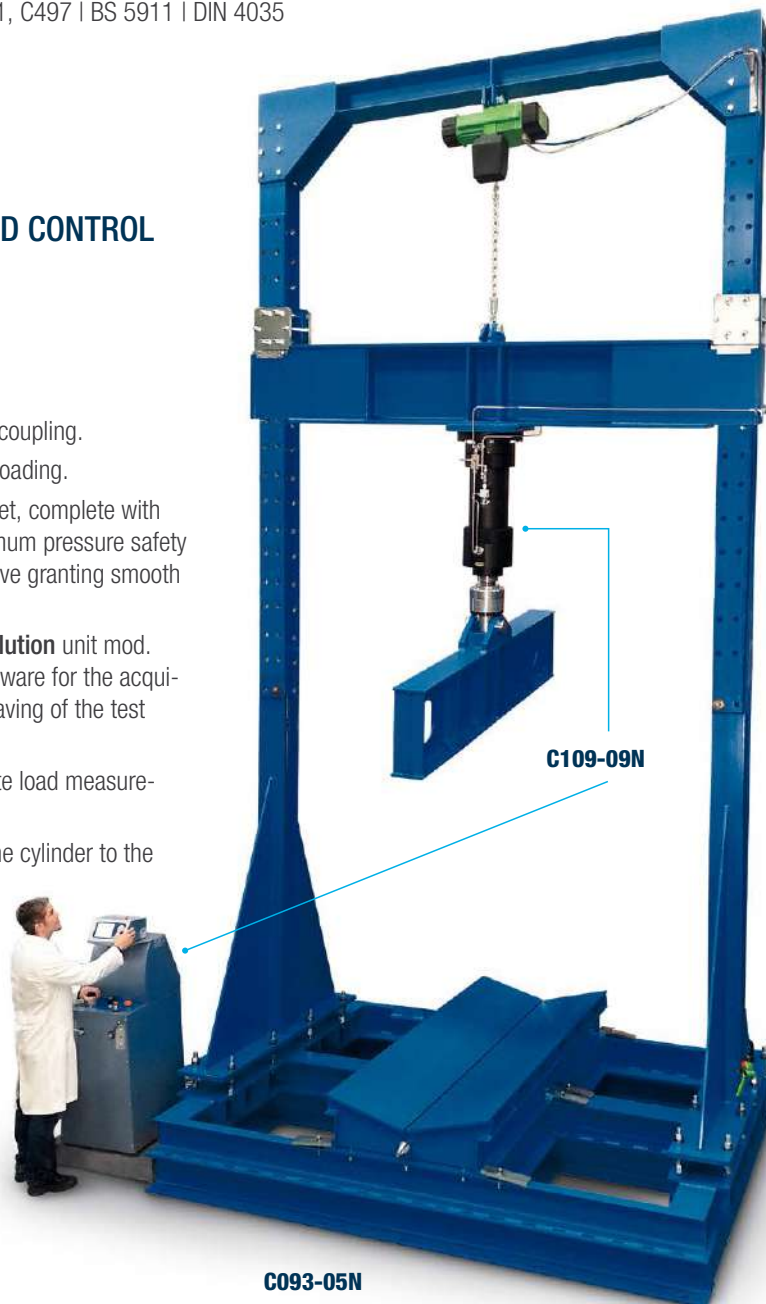

**C093-05N**

#### Note:

The testing frame is delivered disassembled and has to be mounted on site following the instructions. The customer can also manufacture locally the testing frame, and purchase the loading/control system only.

Testing frames with different capacity and features can be manufactured as per customer's requirements.

Quoted testing frame cannot be sold in the CE markets.



**C109-09N detail**

**UNIVERSAL FLEXURAL AND TRANSVERSE MACHINE 150 KN CAPACITY**

FOR FLEXURAL TESTS ON CONCRETE BEAM SPECIMENS MAX. SIZE 200X200X800 MM, FLAT BLOCKS, FLAGSTONES, KERBS, TILES, SLABS, MASONRY UNITS, PIPES, AND ANY TYPE OF MATERIAL HAVING MAX. SIZE 550XH550 MM (LOWER ROLLERS MAX. LENGTH 1325 MM)

STANDARDS: EN 12390-5 | EN 1340:4 | ASTM C78, C293 | AASHTO T97 | BS 1881:118, 6073-1, 7263

150 KN CAPACITY

**MAIN FEATURES**

- Vertical daylight between upper/lower rollers: max. 825 - min. 65 mm adjustable each 76 mm by hand winch with counterweights
- Rollers dimensions: Ø 40x613 mm
- Complete with 4 adjustable and articulated rollers for two point loading
- Distance between lower rollers from 75 to 1325 mm
- Distance between upper rollers from 75 to 575 mm
- Ram travel 110 mm approx.
- Simple action piston with counterweights to optimize frictions
- Power supply: 230V 1ph 50Hz 750W
- Dimensions: 970x1400x2000 mm
- Weight: 800...850 kg approx.



**C093-03N + PC**

UNIVERSAL FLEXURAL 150 kN capacity

**LOAD MEASURING SYSTEM**

MODEL	Motorized	Cyber-Plus Evolution mod. C109N (p. 224)	Servo-Plus Evolution mod. C104N (p. 224)	Digitec mod. C108N (p. 219)	Autotec mod. C098N (p. 219)
<b>C093-02N</b>	▼	▼			
<b>C093-03N</b>	▼		▼		
<b>C093-02D</b>	▼			▼	
<b>C093-03A</b>	▼				▼

## ACCESSORIES FOR UNIVERSAL FLEXURAL 150 KN

**C091-13** UPPER TAMPER (steel made), for concrete KERBS tests. The tamper is mounted on a rotating coupling and fixed to the upper part of the machine to apply a flexural strength on three points on the kerb, without any torsional stress. STANDARD: EN 1340



C091-13

**C093-11** DEVICE for flexural tests on clay blocks for flooring. STANDARD: EN 15037  
UNI 9730-3



C093-11

**C127N** GRAPHIC PRINTER on thermo-paper on board

**C115-01** TWO WAY HYDRAULIC VALVE, connected to the motorized pumping unit of the machine to activate a second frame. Technical details: see p. 318



C115-01

**C097-01** DUAL LOW CAPACITY DIGITAL RANGE, complete with appropriate pressure transducer. Range selectable from 10 kN to 100 kN. Technical details: see p. 313



C097-01

**C097-05** CALIBRATION CLASS 1, starting from 1% of the full range. With a special calibration procedure it is possible to grant Class 1 practically on the full range of the flexural machine.

**C100** SPLITTING TENSILE test device for cylinders. EN 12390-6 | ASTM C496  
Technical details and other models: see p. 314



C100

**C103** SPLITTING TENSILE test device for self blocking pavers and cubes. EN 1338, 12390-6  
Technical details: see p. 314



C103

**E170** COMPRESSION DEVICE to test mortar specimens 40.1x40 mm EN 196 | ASTM C349  
Technical details and other models: see p. 315



E170

**E172-01** FLEXURE DEVICE for mortar prisms 40.1x40x160 mm. EN 196 / EN ISO 679 (it can be used only with the dual low capacity digital range 0-15kN).  
Technical details and other models: see p. 428



E172-01

**C099N**  NEW

INVERTER DEVICE  
Applicable only on Cyber-Plus and Servo-Plus Evolution machines.  
Technical details: see p. 223



C099N

### SOFTWARE for DIGITEC / AUTOTEC or CYBER / SERVO PLUS models

<b>C109-16 (N)*</b>	SOFTWARE for flexural tests on clay blocks
<b>C123 (N)*</b>	SOFTWARE <b>Servonet</b> for remote control through PC
<b>C109-11 (N)*</b>	SOFTWARE for flexural tests
<b>C109-12 (N)*</b>	SOFTWARE for splitting tensile

Technical detail: see p. 18

**(N)\*** for Cyber - Servo Plus models.

## UPGRADING OPTION: COMBINED TWO FRAMES GROUP

All motorized compression testing machines listed in the previous pages can be upgraded with an hydraulic two ways distribution valve for connection and control (alternative, and non-simultaneous) to a second frame, like for example flexural frame or cement compression frame, with obvious functional and economic advantages (especially in the digital solutions).

A hydraulic two ways distribution valve may activate the standard frame or the second combined frame by using only one hydraulic pressure source.

The load of the second combined frame is measured by using one of the channels foreseen on the readout unit connected to the specific pressure transducer fixed on the second frame.

**The additional combined frame is supplied complete with a hydraulic two way distribution valve, specific pressure transducer connected to one channel of the digital readout unit, pipes, connectors, accessories, Matest calibration certificate.**

The two frames group can be combined with many different solutions, according to the specific exigences of the customer, with the possibility to perform:

- **COMPRESSION TESTS ON CONCRETE CUBE, CYLINDER AND BLOCK SAMPLES**, by choosing the standard compression machine among our different available models from 1300kN to 5000kN capacity (see p. 230...281)
- **FLEXURAL TESTS ON CONCRETE BEAMS, FLAT BLOCKS, FLAGSTONES, KERBS, SLABS, TILES** etc. (see p. 288...303)
- **COMPRESSION AND FLEXURE TESTS ON MORTAR SPECIMENS** (see p. 412...431)

The composition of the combined group is obtained by:

### C092-01

#### FLEXURAL FRAME 150 KN CAPACITY

(technical details and specific accessories at p. 290) complete with pressure transducer, two way hydraulic valve, used in conjunction with a digital compression machine (Digitec, Autotec, Cyber-Plus / Servo-Plus Evolution) (see p. 230...281).

### C092-11

#### FLEXURAL OPEN SIDED FRAME 150 KN CAPACITY

(technical details and specific accessories at p. 292) complete with pressure transducer, two way hydraulic valve, used in conjunction with a digital compression machine (Digitec, Autotec, Cyber-Plus / Servo-Plus Evolution) (see p. 230...281).



**C055N**

**C092-01**



**C077N**

**C092-11 + C091-12**

## C092-15 FLEXURAL HIGH STIFFNESS FRAME

200 KN CAPACITY

(technical details and specific accessories at p. 294) complete with pressure transducer, two way hydraulic valve, used in conjunction with a digital compression machine (Digitec, Autotec, Cyber-Plus, Servo-Plus Evolution) (see p. 230...281)



C077N

C092-15 with accessories

## C095N-05 FLEXURAL AND TRANSVERSE MULTIPURPOSE FRAME

320 KN CAPACITY

### C-SHAPED OPEN FRAME

Technical details and specific accessories at p. 296.

Complete with pressure transducer, two way hydraulic valve, used in conjunction with a Servo-Plus Evolution compression machine (see p. 230...281).



C095N-05

## C092-05 COMPRESSION FRAME ON MORTAR SPECIMENS

250 KN OR 500 KN CAPACITY

(mod. E159D, E159N, E159-01D, E159-01N, E161A, E161N, E161-02A, E161-02N technical details and specific accessories at p. 416...421).

Complete with pressure transducer, two way hydraulic valve, used in conjunction with a digital concrete compression machine (Digitec, Autotec, Cyber-Plus / Servo-Plus Evolution) (see p. 230...281).



C055N

C092-05 / C092-06

## C092-06 COMPRESSION/FLEXURAL FRAME ON MORTAR SPECIMENS

Dual range:

0-250 kN (or 500 kN) for compression tests

0-15 kN for flexure tests (mod. E160N, E160-01N, E161-01N, E161-03N technical details and specific accessories at p. 422...425) complete with two pressure transducers, two way hydraulic valve, used in conjunction with a digital concrete compression machine (only Cyber-Plus / Servo-Plus Evolution) (see p. 230...281).

In addition to the proposed groups, it is possible to compose many other alternative testing groups, with the digital display measuring system, like for ex:

- Group formed by two concrete compression frames.
- Group formed by one concrete flexural frame and one mortar compression frame...etc.

Please contact Matest technicians for your needs and you will receive the most suitable solution.



Group Example



itTECH

**CYBER  
PLUS**  
 PROGRESS

**C104-03N  
SERVO-PLUS RESEARCH**

HIGH PERFORMANCE SERVO-PLUS SERVO STRAIN

STANDARDS: EN 14488-3, 14488-5, 14651 | ASTM C1609, C1018, C1550

**Servo-Plus Research** is the ultimate Matest control unit which combines the highly reactive Cyber-Plus Progress electronics together with a hydraulic system specifically designed to execute accuracy tests where the highest performances are required.

Its versatility and number of possibilities make this control unit the best choice for R&D activities and research laboratories, perfect to perform and play with test conditions not yet described by any standards.



Fully customizable test ramps

Firmware and software for FRC tests already included

Performs tests in load, displacement and strain rate control

Possibility to pre-set different sampling frequencies at desired thresholds

Proportional valve granting prompt reaction for FRC tests

Fully automatic frames control expandable to four with electrovalves

Inverter device for decreasing noise pollution, heating and mechanical stress

**ADVANCED APPLICATIONS**

In addition to the common and standard practices, **Servo Research** runs high reactivity tests like those on fiber reinforced concrete (Deflection, CMOD, CTOD, Energy Absorption, Post Failure Behaviour etc.) and **modulus of elasticity** on several types of materials, allowing customization of ramps and cycles (upgrade kit C125-03N) and displaying load, stress, displacement and strain related graphs.

**All tests can be run through its compact-PC touch interface**, making personal computer not mandatory. An external PC can however be connected (H009-01, order separately) to control all tests from remote.



Deflection (ASTM C1609)



CMOD (EN 14651)

Flexural toughness  
(ASTM C1550)

Elastic modulus

Triaxial tests  
and stress path

### HYDRAULIC SYSTEM SPECIFICATIONS

- Max hydraulic pressure: 700 bar
- 4 pistons pump granting oil supply up to 1.35 l/min
- Servo controlled proportional valve with high control frequency
- Inverter device
- Optional forced ventilation oil cooling system

### HARDWARE AND FIRMWARE SPECIFICATIONS

- 16 channels, each one able to control the test and each one suitable to connect load sensors (load cells or pressure transducers), displacement transducers (potentiometric, full bridge, LVDT, magnetostrictive) and deformation transducers (extensometers, strain gauges)
- Each channel effective resolution 24-bit, 16'777'216 divisions
- Closed loop PID control
- Real time adjustment of PID parameters and pace rate during the test (on request)
- Control frequency up to 1 KHz
- Sampling frequency up to 2 kHz
- 7" LCD touch-screen

### ANALOG INPUT CHANNELS

- Selectable power voltage for connection of load, displacement, deformation, LVDT, temperature (PT100, PT1000, NTC) transducers and strain gauges
- Data acquisition synchronized on all channels
- Calibration of the 16 channels in divisions (up to 40 steps), with polynomial function which allows the best approximation of readings accuracy over the whole test range

### TEST EXECUTION

Compact PC for local control and software for remote control in order to perform the following tests:

- Compression, flexure and splitting
- Elastic modulus and Poisson's Ratio on rocks and concrete (add C125-03N)
- Triaxial and stress path test on rocks (add C125-03N and C104MLPP for lateral pressure)
- Toughness of FRC and energy absorption of sprayed concrete tests
- FRC tests: deflection, CMOD, CTOD and flexural test



**C096F + C104-03N + C089F + E183F**

**ACCESSORIES**

**C115N**

**AUTOMATIC ELECTROVALVE**

Optional valve to be added to C104-03N for automatic selection of extra frames (up to four).

**C125-03N**

Upgrade kit for elastic modulus and Poisson's Ratio tests allowing pace rate control also when releasing the load.

**H009-01**

**PERSONAL COMPUTER**

Complete with LCD monitor, keyboard, mouse, connection cables, it is applicable with all the Matest testing machines equipped with digital display measuring system. The PC supply includes the installation and the setting up of the purchased Software.

**C127N**

**ON-BOARD GRAPHIC PRINTER**

On-board printer for digital models.

**C128**

**BENCH LASER PRINTER**

For the graphic and test certificate printing, applicable on all Matest testing machines with digital display measuring system. The connection is direct by parallel interface also without PC

**C104-14N**

Support for mouse and keyboard

**C104-13N**

Optional cooling system for intensive use or warm environment

**ORDERING INFO**

	FRC TESTS		FRC TESTS ELASTIC MODULUS TESTS	FRC TESTS ELASTIC MODULUS TESTS
				TRIAXIAL TEST AND STRESS PATH
	ASTM C1609	ASTM C1550	EN 12390-13, EN 13412,	EN 14580, EN 1926,
	EN 11039-2		EN 13286-43	EN 1926, EN 14580
	EN 14651		ASTM C469	ASTM D7012,
	EN 14488-3		ISO 6784	ASTM D2664,
	EN 14488-5		UNI 6556	ASTM D3148,
			DIN 1048	ASTM D5407
			BS 1888:121	ISRM
C104-03N	•	•	•	•
C115N			•	•
C125-03N			•	•
<b>Flexural frames:</b>				
C090-06CF 200 kN, basic model				
C095F 320 kN, advanced model	• (choose a frame)	• (choose a frame)	• (choose a frame)	• (choose a frame)
C096F 360 kN, advanced model				
<b>Compression frames:</b>				
C086, C087, C088, C089 series 2000 up to 5000 kN frames only (check p. 260 of general catalogue)			•	•
C104MLPP (lateral pressure)				•

**Notes:** All accessories for C104-03N must be installed in factory  
Specific accessories must be added basing on each test  
Other suitable compression frames can be connected on request

## ACCESSORIES TO COMPRESSION AND FLEXURAL TESTING MACHINES

### C097-01 DUAL LOW CAPACITY DIGITAL RANGE

(From 1/3 to 1/20 of the nominal range), complete with **Appropriate pressure transducer**, hydraulic installation and cock, fitted on testing machines equipped with digital display measuring unit. This solution offers very high accuracy also for measurements of low strength, which is necessary to perform compression tests on mortar specimens, flexural tests on concrete beams, split cylinder test on cylinder and cube specimens, tests on kerbs, slabs etc., by utilizing a concrete compression machine.



C097-01

### C097-02 DUAL LOW CAPACITY DIGITAL RANGE 0-300 kN

Complete with **strain gage load cell**, cables, fitted on concrete compression testing machines equipped with digital display measuring system.

This solution eliminates the weights of the piston and lower compression platen, packing set frictions etc., granting very high accuracy (Class 1; max. error within  $\pm 0.5\%$ ) in the measuring range 30...300 kN.



C097-02

### C105 DEVICE WITH CENTRAL SCREW

Very practical to adjust the light between the compression platens of a machine, according to the height of the specimen to be tested. Recommended solution for machines equipped with big sized platens. This device can be foreseen on all models of concrete compression machines, except High Stability models.



### C097-05 CLASS 1 STARTING FROM 1% OF THE FULL RANGE

Applicable only to digital machines. By following a special calibration procedure, Matest is capable to grant the Class 1 practically on the full range, upgrading the machine to be used for a considerable number of applications where low strength value are expected, including:

- Lightweight concrete, or early strength concrete
- Small size samples, soil cement mixtures
- Flexural and tensile tests, slabs, kerbs, etc.

### C097-08 OFFICIAL ACCREDIA HARDNESS CERTIFICATE

(Equivalent UKAS, ENAC, DAKKS, SAS, COFRAC etc.) of upper and lower compression platens. Minimum hardness: 55 HRC.

TEST REPORT		MATEST S.p.A.	
Number: SDC/091/1/13	Date: 20/11/2013	VIA DELLE INDUSTRIE, 25	24028 TREVOLFO BG
OMECO Ref.: 2340	Page 1 of 1		
CUSTOMER Ref.: CRO 60677 25/1/13			
Sample: N 2 PLATES Ø 287mm TX 80 mm			
Identification: A1 - B1			
Date of receipt: 27/11/2013			
Test standards: UNI EN ISO 6508-1:2000			
Equipments: Hardness test machine identified SDC-0050			
Obtained results:			
ROCKWELL HARDNESS TEST			
Identif.	A1	B1	HRC
	A1	B1	57.5 - 52.0 - RC2
	B1	B1	55.8 - 51.0 - 61.0
<small>This test report concerns only the samples submitted to the test. If not otherwise indicated, the sampling operation was justified to the Customer.</small> <small>Date of execution: 20/11/2013</small> <small>At: OMECO Lab. - Abramo S. Alessandro - Bg -</small> <small>Notes: Measurement uncertainty, we refer to table "Incertezze" of Omece procedure IFCM-010 Rev. 8 Ed. 11 (data available on request).</small> <small>The certificate is to be kept until the test specimen is 20 days previous to the date of expiration and 3 months for steel of other fields.</small>			
Operator:		Technical Manager:	
A. SACCOMI		M. CASARIL	
Document 0010			

C097-08

### H009-01 PERSONAL COMPUTER

Complete with LCD monitor, keyboard, mouse, connection cables, it is applicable with all the Matest testing machines equipped with digital display measuring system. The PC supply includes the installation and the setting up of the purchased Software (see p. 18)



H009-01

### C128 BENCH LASER PRINTER

For the graphic and test certificate printing, applicable on all Matest testing machines with digital display measuring system. The connection is direct by parallel interface also without PC.



C128

## ACCESSORIES TO COMPRESSION AND FLEXURAL TESTING MACHINES

### SPLITTING TENSILE TEST DEVICES

For cylindrical specimens.

STANDARDS: EN 12390-6 | ASTM C496 | NF P18-408

Model	Cylinders Ø x height mm	Weight kg	Height mm
C100*	150x300, 160x320, 6"x 12"	20	280
C101*	100x200, 110x220, 4"x 8"	12	220
C102*	40 x 80	1	90

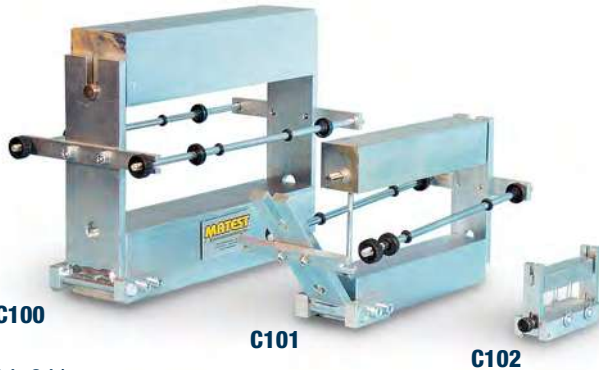

#### C101-01\* SPLITTING TENSILE TEST DEVICE

For cylindrical specimens from Ø 100x200 mm (4"x8") to Ø 160x320 mm (6"x12").

The base is equipped with flat springs centering and keeping in position the specimen.

Two columns with adjustable height sustain the upper plate by two springs.

This item is an alternative solution to mod. C100 + C101

**Dimensions:** 350x250xh264 mm

**Weight:** 17 kg approx.



#### C103\* SPLITTING TENSILE TEST DEVICE

Used to perform tests on concrete cube specimens 100 and 150 mm and on concrete block pavers.

STANDARDS: EN 12390-6, EN 1338

**Dimensions:** 350x250x264 mm

**Weight:** 17 kg approx.

**\*Note:** To perform the test, these devices have to be used with a concrete compression machine equipped with a low capacity measuring range (see dual low range, p. 313), or with a flexural frame.



#### C103-01\* SPLITTING TENSILE TEST DEVICE

Same as mod. C103 but to perform tests on concrete block pavers having max. dimensions 300 x 500 mm, and for tests on concrete cube specimens 100, 150, 200 mm, and any type of block and prismatic specimens. This splitting device is directly fixed on the compression platens of the block testers having 2000kN or 3000kN capacity.

**Weight:** 10 kg approx.



C103-01



C103-02

#### C103-02\* SPLITTING TENSILE TEST DEVICE

Same to mod. C103-01, but to be fixed to the flexural frames serie C091-02N (p. 292), C090-06 (p. 294), C095N (p. 296) and C096N (p. 300).

### ACCESSORIES

- C100-01** STANDARD: EN 12390-6  
PACKING STRIPS, dimensions 4x10x350 mm to be used for splitting tensile tests with mod. C100, C101, C101-01 C103. Pack of 100 pieces.
- C100-02** STANDARDS: EN 1338, EN 12390-6  
PACKING STRIPS, dimensions 4x15x350 mm to be used for splitting tensile tests with mod. C103. Pack of 100 pieces.
- C100-03** STANDARDS: EN 1338, EN 12390-6  
PACKING STRIPS, dimensions 4x15x540 mm, to be used for splitting tensile tests with the device mod. C103-01. Pack of 100 pieces
- C109-12(N)** SOFTWARE UTM2 (Universal Testing Machine 2)  
Licence for TENSILE SPLITTING TESTS on cylinders, cubes and concrete blocks.  
STANDARDS: EN 1338, EN 12390-6

General description and technical details: see UTM2 p. 18

## ACCESSORIES TO COMPRESSION AND FLEXURAL TESTING MACHINES

### C106 FLEXURAL DEVICE FOR TWO POINT AND CENTRE POINT TESTS ON CONCRETE BEAMS 100X100X400/500 AND 150X150X600/750 MM

STANDARDS: EN 12390-5 | ASTM C78, C293 | AASHTO T97  
BS 1881:118

Equipped with two lower rollers, one of them articulated, and two upper rollers for third point tests.

- Two fix distances between lower rollers: 300 and 450 mm
- Two fix distances between upper rollers: 100 and 150 mm

It is possible to place in the centre only one upper roller for centre point tests.

To perform the flexural test, this device has to be used with a concrete compression machine foreseen of low capacity measuring range (mod. C097-01, C097-02) see p. 313

**Dimension:** 610x200x320 mm

**Weight:** 27 kg approx.

### E170 COMPRESSION DEVICE TO TEST MORTAR PRISMS 40.1X40X160 MM BROKEN IN FLEXURE

STANDARDS: EN 196-1 | ASTM C349

To be used with a concrete compression machine foreseen of low capacity measuring range (mod. C097-01, C097-02) or with a flexural frame.

**Dimensions:** Ø 153xh182 mm.

**Weight:** 12 kg approx.



E170

### E171 COMPRESSION DEVICE TO TEST MORTAR CUBE SPECIMENS 50 MM (2")

STANDARD: ASTM C109

It is possible to test also cylindrical specimens Ø 50xh50 mm. To be used with a concrete compression machine foreseen of low capacity measuring range (mod. C097-01, C097-02) or with a flexural frame.

**Weight:** 12 kg approx.



E171

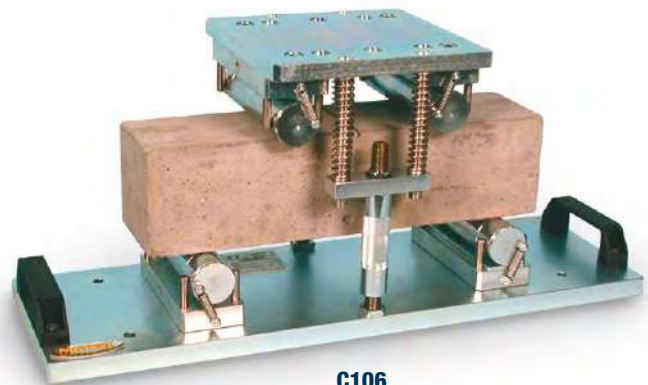

C106

### E171-01 COMPRESSION DEVICE TO TEST MORTAR CUBE SPECIMENS 70.7 MM

STANDARD: BS 4550

It is possible to test also cylindrical specimens Ø 70x70 mm.

To be used with a concrete compression machine foreseen of low capacity measuring range (mod. C097-01, C097-02) or with a flexural frame.

**Weight:** 12 kg approx.



E171-01

### C091-13 CONCRETE KERBS AND SLABS DEVICE FLEXURAL STRENGTH MEASUREMENTS

STANDARD: EN 1340

The equipment consists of a steel tamper mounted on a rotating coupling which is fixed to the upper part of the flexural testing machine (to be selected from serie mod. C090-06, C091, C093 and C095N) to apply a flexural strength on three points on the concrete kerb, without any torsional stress.



C091-13

## ACCESSORIES TO COMPRESSION AND FLEXURAL TESTING MACHINES

### UNBONDED CAPPING PADS AND RETAINERS

STANDARDS: ASTM C1231 | AASHTO T22, T851

Used for compression tests on concrete cylinder specimens, as an alternative method to the sulphur capping and grinding machine. Two steel capping retainers are applied on the two flat surfaces of the cylinder. Two neoprene pads are put between them, for a better load distribution.

The neoprene pads are available in two models:

- 60 shore hardness pads for expected strength from 10 to 48 MPa
  - 70 shore hardness pads for expected strength over 48 MPa
- The system is not applicable for expected strength lower than 10 Mpa

#### MODELS

- C107-09** CAPPING RETAINERS (couple) for Ø 100x200 mm cylinders.
- C107-10** CAPPING RETAINERS (couple) for Ø 150x300 mm and 6"x12" cylinders.
- C107-12** CAPPING RETAINERS (couple) for Ø 160x320 mm cylinders.
- C107-18** NEOPRENE PADS (couple) 60 shore A for Ø 100x200 mm and 4"x8" cylinders.
- C107-19** NEOPRENE PADS (couple) 70 shore A for Ø 100x200 mm and 4"x8" cylinders.
- C107-20** NEOPRENE PADS (couple) 60 shore A for Ø 150x300 mm and 6"x12" cylinders.
- C107-21** NEOPRENE PADS (couple) 70 shore A for Ø 150x300 mm and 6"x12" cylinders.
- C107-25** NEOPRENE PADS (couple) 60 shore A for Ø 160x320 mm cylinders.
- C107-26** NEOPRENE PADS (couple) 70 shore A for Ø 160x320 mm cylinders.
- C107-29** NEOPRENE SHEET (couple) 60 shore A. Dimension: 600x400x12 mm  
For tests on blocks.

#### Note:

The capping retainers can be used only with compression testers having increased vertical clearance of the testing chamber, respectively to minimum 356 mm for the cylinders Ø 150x300 mm or 6"x 12"; and minimum 376 mm for the cylinders Ø 160x320 mm.

### C110-30 UPPER COMPRESSION PLATEN + SPHERICAL SEAT

For tests on cylinder specimens diameters 100x200, 150x300, 160x320 mm and 4"x8", 6"x12" (to fix on the testing machine, in replacement of the standard one where requested), to meet the ASTM C39, AASHTO T22 Specifications. Platen dimensions: Ø 165x30 mm

Weight: 10 kg approx.



**C110-30**



**C107-29**



Example of utilization

### AUTO-CENTERING DEVICE

For cubes 100 and 150 mm side and cylinders Ø 100 and 150 mm. The lower compression platen of the testing machine is marked with a serie of concentric circles to facilitate the correct centering of the specimens. However to grant a rapid and accurate centering of concrete cube and cylinder specimens, this "Auto-Centering" device is recommended.

#### MODELS

- C107** Auto-Centering Device, to be used with compression machine having platen Ø 216 mm (1300, 1500 and 2000 kN)
- C107-01** Auto-Centering Device, to be used with compression machine having platen Ø 287 mm (3000 kN and high stability machines)



**C107**

## ACCESSORIES AND SPARES TO COMPRESSION TESTING MACHINES

### SAFETY GUARDS

Compliant with CE Safety Directive, manufactured of highly resistant transparent polycarbonate material and complete with hinges and lock. The guards are both on front and back sides.



**C121**

### MODELS

- C121** For machines 1300kN and 1500kN
- C121-05** For machines 2000kN (mod C051 to C058-05N)
- C121-01** For machines with block platens 2000kN (C073 to C078N)
- C121-06** For machines high stability 2000kN (C089 to C089-04N)
- C121-10** For machines high stability with block platens 2000kN capacity (mod C089B to C089-22N)
- C121-07** For machines 3000kN (mod C066 to C071N) and high stability 3000kN (mod C089-06 to C089-10N)
- C121-08** For machines with block platens 3000kN (mod C079-01 to C079-06N) and high stability with block platens 3000kN (C089-15 to C089-19N)
- C121-04** For machines 5000kN (mod C086-02 to C086-03N)

### C126 BENCH

Used to hold the compression (or flexural) testing frame, to set the machine at a proper height for its utilization.

Alternative solution to a concrete holding base.

Made from heavy welded steel, it can be moved in the laboratory both from front or lateral side by a forklift.

When ordering, please specify the model of testing machine the bench is to be designed.

**Weight:** 55 kg approx.



**C126**

### C121-51 DOOR STOP SAFETY SWITCH

This door locking electric switch if fixed on the front door of the compression machine as safety device. It cuts off mains and stops the machine when the door is open.

This locking switch can be installed only on digital compression machines equipped with safety guards with hinges and lock.

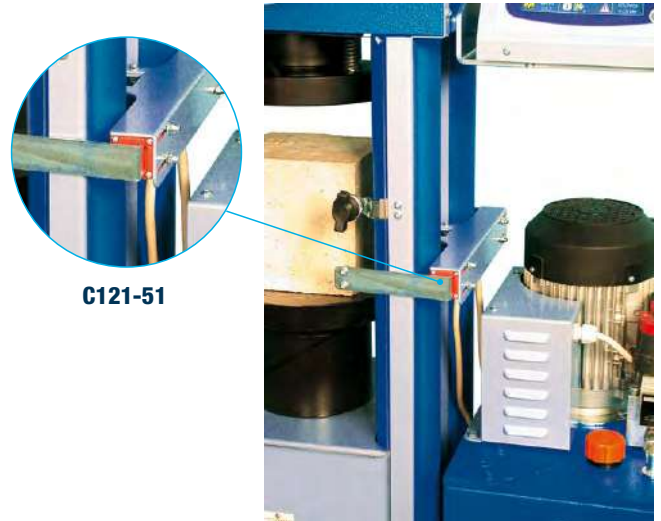

**C121-51**

### GAUGE

Diameter 250 mm foreseen for max. load pointer, zero adjustment and mirror face. Spare part for compression and flexure machines. Supplied pre-calibrated.



**C118-05**

Models	Gauge
<b>C118-14</b>	Range 0 - 1300 kN
<b>C118-03</b>	Range 0 - 1500 kN
<b>C118-04</b>	Range 0 - 600 kN for 1300-1500kN machine
<b>C118-05</b>	Range 0 - 2000 kN
<b>C118-06</b>	Range 0 - 600 kN for 2000kN machine
<b>C118-07</b>	Range 0 - 3000 kN
<b>C118-08</b>	Range 0 - 600 kN for 3000kN machine
<b>C118-09</b>	Range 0 - 150 kN for flexure press C090 serie
<b>C118-10</b>	Range 0 - 150 kN for flexure press C091, C093 serie
<b>C118-11</b>	Range 0 - 1500 kN for tensile press H010
<b>C118-12</b>	Range 0 - 300 kN for cement machine
<b>C118-13</b>	Range 0 - 50 kN for cement machine



**ACCESSORIES AND SPARES TO COMPRESSION AND FLEXURAL TESTING MACHINES**
**C113  
 PUMPING UNIT, HAND OPERATED**

Complete with tank, accessories and connectors.  
 Spare part for compression and flexure machines.

**Weight:** 20 kg approx.

**C114  
 PUMPING UNIT, MOTORIZED**

Complete with tank, speed selector, hydraulic cock, accessories and connectors.

Spare part for compression and flexure machines.

Hydraulic pressure: 0...700 Bar

Oil supply from 0.05 to 0.7 litre/min.

Supplied **without** hydraulic oil to be ordered separately (see mod. C114-10N).

**Power supply:** 230V 1ph 50 Hz 750 W

**Weight:** 40 kg approx.

**C114-01  
 PUMPING UNIT, MOTORIZED**

Identical to mod. C114, but equipped also of a two way hydraulic valve (C115-01) to activate, alternatively, two testing frames.

Supplied complete.

**C114-10N  
 HYDRAULIC OIL**

For compression/flexural testing machines.

Can of 20 litres.

**C115-01  
 TWO-WAY HYDRAULIC VALVE**

Installed on the pumping unit mod. C114, to activate alternatively two testing frames by using the same pumping unit.

Complete with protection case.

**C115N  
 AUTOMATIC HYDRAULIC VALVE ➤ NEW**

Installed on the pumping unit of the Servo-Plus machines to automatically activate alternatively two testing frames. Upon request, it is possible to connect up to four different frames. Our technical dept. is at your disposal for any specific demand.



**C115N** four frames connection

**PRESSURE TRANSDUCER**

Used in conjunction with digital units Cyber-Plus C109N, Servo-Plus C104N, Digitec C108N, Autotec C098N.

Supplied complete with cable, calibration certificate.

Nominal sensitivity: 2 mV/V. Accuracy:  $\pm 0.5\%$

Models	Pressure Transducer
<b>C116-01N</b>	range: 0 - 10 bar
<b>C116-02N</b>	range: 0 - 20 bar
<b>C116-03N</b>	range: 0 - 35 bar
<b>C116-04N</b>	range: 0 - 50 bar
<b>C116-05N</b>	range: 0 - 100 bar
<b>C116-06N</b>	range: 0 - 200 bar
<b>C116-07N</b>	range: 0 - 350 bar
<b>C116-08N</b>	range: 0 - 500 bar
<b>C116-09N</b>	range: 0 - 700 bar
<b>C116-10N</b>	range: 0 - 400 bar
<b>C116-11N</b>	range: 0 - 600 bar
<b>C116-12N</b>	range: 0 - 160 bar
<b>C116-13N</b>	range: 0 - 60 bar



**C116-01N...C116-13N**



**C115-01**  
 Without case



**C114-01**



**C114**



**C113**

**C115-01**

## ACCESSORIES AND SPARES TO COMPRESSION AND FLEXURAL TESTING MACHINES

### PACKING SET

Comprising three elements, for piston/cylinder coupling

#### MODELS

- C122** For compression machine 1200 kN capacity
- C122-01** For compression machines 1300-1500 kN capacity
- C122-02** For compression machine 2000 kN capacity
- C122-03** For compression machine 3000 kN capacity
- C122-04** For flexure machine 150 kN capacity, C090 serie
- C122-06** For flexure machine 150kN capacity, C091, C093 serie
- C122-07** For flexure machine 200 kN capacity, C090-06 and C090-07 serie
- C122-05** Packing set for the hand-operated pump of testing machines
- E161-15** For Cement testing machines mod. E151 to E161
- E183-11** For Cement machines mod. E181, E183, piston 250kN
- E183-12** For Cement machines mod. E181, E183, piston 15kN



**C122...E183-12**

### C110-15 LOWER COMPRESSION PLATEN



Hardened and rectified,  $\varnothing$  216x40 mm, complete with distance piece 20 mm high to test cubes 100, 150 mm and cylinders up to  $\varnothing$  160x320 mm

**Weight:** kg 11.3 + kg 3

This simple and low cost solution is recommended for an easier use of the **High Stability** Compression Testing Machines and the compression machines equipped with lower platen  $\varnothing$  287 mm to test cube specimens 100 and 150 mm side and cylinders up to  $\varnothing$  160x320 mm

It consists of replacing the **heavy** lower compression platen having  $\varnothing$  287 mm by 60 mm height (weight 30.3 kg) with a smaller platen having only  $\varnothing$  216 mm by 40 mm height (weight 11.3 kg), together with the suitable 20 mm high distance piece.

This test solution allows a much easier removal and positioning of the lower compression platen when the distance pieces have to be fitted in and out, based on the specimen size the user needs to test (cube 100 or 150 mm or cylinder 150x300 mm or 160x320 mm diameter).

This solution is **not valid** only when a cube specimen 200 mm side has to be tested. In this case the lower compression platen 287 mm diameter must be foreseen to cover the full surface of the 200 mm cube specimen.



**C110-15**



**C089-02N** with **C110-15** light lower plate  $\varnothing$  216 mm (weight 11.3 kg)



**C089-02N** with standard lower plate  $\varnothing$  287 mm (weight 30.3 kg)

**ACCESSORIES AND SPARES TO COMPRESSION AND FLEXURAL TESTING MACHINES**
**COMPRESSION PLATENS**

Surface hardened over 55 HRC and finish-grinding.

**UPPER PLATEN**

Model	Ø mm	Machine
<b>C110</b>	165x30	1200kN
<b>C110-01</b>	216x30	1300kN, 1500kN and 2000kN
<b>C110-02</b>	287x51	3000kN and 2000kN serie C058
<b>C110-03</b>	287x60	2000kN and 3000kN high stability complete with "ball seating"

**LOWER PLATEN**

Model	Ø mm	Machine
<b>C110-11</b>	165x30	1200kN
<b>C110-12</b>	216x30	1300kN, 1500kN and 2000kN
<b>C110-13</b>	287x51	3000kN and 2000kN serie C058
<b>C110-14</b>	287x60	2000kN and 3000kN high stability

**C112-10**

UPPER and LOWER COMPRESSION PLATENS, complete with "ball seating", dimensions 510x245x55 mm for tests on blocks.

**C112-11**

UPPER and LOWER COMPRESSION PLATENS, complete with "ball seating", dimensions 510x320x55 mm for tests on blocks.

**C112-05**

Kit of 4 handles to lift the lower platen, making the positioning of distance pieces easier.

**AS AN ALTERNATIVE**
**C111-50**
**DISTANCE PIECE**

To be used with compression testers equipped with rectangular platens 510x320 mm to test blocks.

This device eliminates the heavy procedure to lift the lower rectangular platen and to add distance pieces to perform compression tests also on cube specimens.

This distance pieces is fixed over the lower rectangular platen through 4 adjustable couplers allowing a quick, correct and stable fixing.

On the distance piece it is now possible to put the round compression platen Ø 216 or 287 mm foreseen by the specific machine. This distance piece is finish-grinded (suitable also for high stability testers), has Ø 210 mm, height 20 mm.

**Weight:** 3 kg approx.

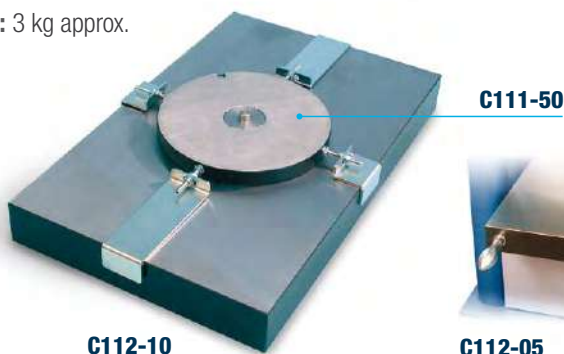
**C112-10**
**C111-50**

**C112-05**
**DISTANCE PIECES**

Used to reduce the vertical clearance between the compression platens, according to the height of the specimen to be tested, so to avoid the ram to make its max. excursion (approx. 50-55 mm) without having compressed the specimen.

The distance pieces are placed between the ram and the lower compression platen.

**MODELS**

DISTANCE PIECES Ø 140 mm for machines: 1200kN, 1300kN, 1500kN, 2000kN (C051 to C056N)

**C111-30** High 20 mm      **C111-21** High 50 mm

**C111-03** High 100 mm      **C111** High 176 mm

**C111-02** High 226 mm

DISTANCE PIECES Ø 200 mm for machines: 2000kN (C058 to C058-05N), 3000kN (C066 to C071N), 2000kN blocks (C073 to C078N), 3000kN blocks (C079-01 to C079-06N)

**C111-31** High 20 mm      **C111-22** High 50 mm

**C111-26** High 76 mm      **C111-04** High 126 mm

**SLOTTED** DISTANCE PIECES Ø 150 mm for central screw machines: 2000kN (C073 to C078N), 3000kN (C079-01 to C079-06N)

**C111-27** High 20 mm      **C111-23** High 50 mm

**C111-28** High 76 mm      **C111-08** High 126 mm

DISTANCE PIECES Ø 210 mm, finish-grinding, for **high stability** machines: 2000kN, 3000kN, 2000kN blocks and 3000kN blocks.

**C111-32** High 20 mm      **C111-24** High 50 mm

**C111-25** High 73 mm

**C111-16** DISTANCE PIECE, high 50 mm for flexure machines serie C090

**C111-17** DISTANCE PIECE, high 40 mm for flexure machines serie C090-07N

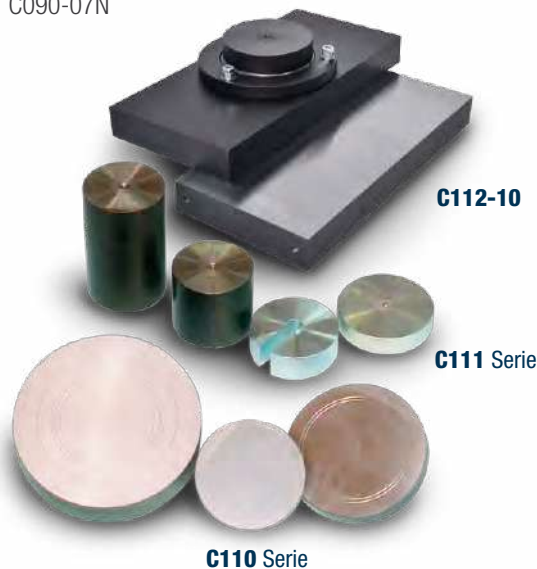
**C112-10**
**C111 Serie**
**C110 Serie**

S205N

**UNITRONIC 50 KN** >NEW**UNIVERSAL MULTIPURPOSE FRAME**

FOR COMPRESSION / FLEXURAL TESTS, 50 KN MAX. CAPACITY LOAD  
WITH AUTOMATIC LOAD OR DISPLACEMENT/DEFORMATION CONTROL, testing:

**Concrete:**

- FLEXURE ON BEAMS
- FLEXURE ON TILES

**Clay Blocks, Tiles:**

- PUNCHING
- TRANSVERSE/DEFORMATION on adhesives for tiles - EN 12002 (see p. 506)

Cement, Asphalt, Metal, Wires, Ropes, Plastic, Papers, Textiles, etc.

Rock and stones, Soil

Unitronic technical details and additional specific tests are described at p. 500

**SPECIFIC APPLICATIONS****FLEXURAL TEST WITH CENTRE POINT ON CONCRETE BEAMS AND CLAY TILES**

STANDARDS: EN 12390-5 | ASTM C78, C293 | BS 1881:118

Test development with load control.

**NEEDED ACCESSORIES**

- S337-34** STRAIN GAUGE LOAD CELL, 50 kN capacity
- S205-18** FLEXURE DEVICE for centre point loading to test clay tiles and concrete beams dimensions 100x100x400(500) mm. Consisting of lower beam with two bearers (one articulated) adjustable from 100 to 315 mm, and upper central articulated bearer fixed to the load cell. Bearer dimensions: Ø 38 mm by 300 mm long.
- Weight:** 20 kg approx.

**C109-11N** SOFTWARE for flexure tests on concrete beams.

**S205-18****S205N + S337-34****PUNCHING TEST ON CLAY BLOCKS**

STANDARDS: EN 15037 | UNI 9730-3

Test development with load control.

**NEEDED ACCESSORIES**

- S337-32** STRAIN GAUGE LOAD CELL 10 kN capacity.
- C093-11** FLEXURAL PUNCHING DEVICE
- S205-15** HOLDING BEAM for the punching device

**C093-11****C095-05****FLEXURE TEST ON CLAY BLOCK PORTION**

STANDARD: UNI 8942-3, 9730-3

The apparatus consists of:

- digital loading balance 16 kg capacity x 0.1g sens, with software to display and hold the failure load
- flexure device fitted on the balance, with central rotating knob for load application.

The strip sample is got from one internal wall of the clay block. The load is obtained by simply rotating the knob that applies a flexural pressure on the strip sample up to the failure. The balance displays and holds the failure load.

**Weight:** 14 kg approx.

**C095-05**

**S206N**
**UNITRONIC 200 KN**
**UNIVERSAL MULTIPURPOSE FRAME**

FOR COMPRESSION / FLEXURAL TESTS, 200 KN MAX. CAPACITY LOAD

AND TENSILE TESTS 50 KN MAX. LOAD

WITH AUTOMATIC LOAD OR DISPLACEMENT/DEFORMATION CONTROL, testing:

- FLEXURE ON CONCRETE BEAMS AND TILES
- COMPRESSION ON MORTAR CUBES 40, 50, 70 MM
- PUNCHING ON CLAY BLOCKS FOR FLOORING

Asphalt, Metal, Wires, Ropes, Plastic, Papers, Textiles, etc.

Rock and stones, Soil

Unitronic 200 kN technical details and additional specific tests

are described at p. 508

**SPECIFIC APPLICATIONS**
**FLEXURAL TEST WITH CENTRE POINT**

ON CONCRETE BEAMS AND CLAY TILES

STANDARDS: EN 12390-5 | ASTM C78, C293 | BS 1881:118

**S205-18**

Flexure device with centre point loading to test clay tiles and concrete beams dimensions 100x100x400(500) mm. Consisting of lower beam with two bearers (one articulated) adjustable from 100 to 315mm, and upper central articulated bearer fixed to the load cell. Weight: 20 kg approx.

**S205-18**
**C109-11N**

Software for flexural tests on concrete beams (p. 18)

**TWO POINT FLEXURAL AND TRANSVERSE TESTS**

ON CONCRETE BEAMS AND BENDING TEST METHOD ON GLASS-FIBRE REINFORCED CONCRETE

STANDARDS: EN 1170-4, EN 12390-5 | ASTM C70, C29

**S205-16**

Two-point flexure device to test glass-fibre reinforced cement. Rollers dimensions: Ø 40 by 310 mm long. Lower rollers adjustable from 110 to 310 mm. Upper rollers adjustable from 45 to 120 mm. Weight: 20 kg approx.

**S205-16**
**C109-11N**

Software for flexure tests on concrete beams (p. 18)

**FLEXURAL TEST ON CONCRETE BEAMS**

 STANDARDS: EN 12390-5 | ASTM C78, C293 | AASHTO T97  
 NF P18-407 | BS 1881:118 | UNE 83305

**C106**

Flexure device (p. 315)

**C109-11N**

Software for flexural tests on concrete beams (p. 18)

**C106**

**S206N**
**SPLITTING TENSILE TEST ON CONCRETE CYLINDERS**

STANDARDS: EN 12390-6 | ASTM C496 | NF P18-408 | BS 1881:117

**C101-01**

Splitting tensile test device (technical details p. 314)

**C100-01**

Packing strips (100 pieces)

**C109-12N**

Software for splitting tensile test (p. 18)

**C100-01**
**SPLITTING TENSILE TEST ON CONCRETE CUBES AND BLOCK PAVERS**

STANDARDS: EN 1338 | EN 12390-6

**C103**

Splitting tensile test device (p. 314)

**C100-02**

Packing strips (100 pcs)

**C109-12N**

Software for Splitting tensile test (p. 18)

**C100-02**
**PUNCHING TEST ON CLAY BLOCKS**

STANDARD: EN 15037 | UNI 9730-3

**C093-11**

Punching device for clay block for flooring tests

**S205-15**

Holding beam for the device

**C109-16N**

Software for the punching test (p. 18)

**S205-11**

### C094N PORTABLE DIGITAL PRESS, 56 kN CAPACITY

Used for compression tests on small cylinder specimens and core samples up to  $\varnothing$  60x100 mm

The load is applied by a hand pump, and is measured by a **high precision electric load cell** with a digital display unit range 0-56 kN providing:

- 65,000 divisions
- 0.001 kN resolution
- Linearity: 0.05%
- Hysteresis: 0.03%
- Repeatability: 0.02%

The compression platens have  $\varnothing$  65 mm, the upper one has a spherical seat and the vertical daylight is 110 mm

Complete with wooden carrying case, accessories.

**Dimensions:** 370x320x710 mm

**Weight:** 25 kg approx.



C094N

#### ACCESSORY

- A125-01** SET OF TWO HARDENED CONICAL POINTS, to modify the press mod. C094N into the **Point load tester** (see section aggregates mod. A125N p. 64), for the rock strength index test.



A125-01

### C095T FLEXURAL TESTING MACHINE, CAPACITY 50 kN

This simple hand-operated testing machine allows to perform flexural tests on concrete tiles EN 491, clay tiles EN 538, hollow tiles UNI 2107, flat blocks, paving slabs, tiles, bricks, as well as punching tests on clay bricks.

The machine consists of a steel frame, one upper rotating bearer and two lowers one with adjustable distance, a mechanical hand-operated jack and a load proving ring of 10 kN capacity precision to measure the applied load.



C095T

#### TECHNICAL SPECIFICATIONS

- 10kN load ring, complete with calibration certificate (on request rings with inferior or superior capacity up to 50kN)
- Horizontal span: 520 mm
- Maximal vertical span (accessories not included) 670 mm
- Distance between lower bearers adjustable from 50 to 500 mm
- Precision: 1% of applied load

**Dimensions:** 620x650x1500 mm

**Weight:** 120 kg approx.

### C096 IMPACT FAILURE TEST ON TILES AND PAVING MATERIALS

STANDARD: Art. 3 n° 2234 - 1939

Utilized to verify the quality of paving materials like tiles, ceramics, bricks, floor tiles etc. by the impact method.

The specimen under test is placed on the base of the device which has been previously filled with sand. Then a spherical ball of approx. 1000 gr. is dropped on the tile from a known height, to measure the height under which the specimen will break.

**Dimensions:**

810x810x1300 mm

**Weight:** 70 kg approx.



C096

## ABRASION MEASURING BASED ON BÖHME

### C129 ABRASION TESTER BÖHME

STANDARDS: EN 1338, 1339, 1340 | EN 13748-2, 13892-3  
 EN 14157 | DIN 52108



**C129**

The instrument measures a volume loss in a specimen under abrasion test and it's used in tests such as:

- paving stones
- concrete slabs
- slabs made of natural rocks
- natural stone slabs
- terrazzo tiles

The test is performed by positioning a specimen to be verified in a abrasion tester Böhme apparatus on the test track on which has been spread normalized abrasive; the grinding wheel it's made rotate and the specimen submitted to the abrasive load of 294 N for a certain number of cycles.

Before doing a test, establish the specimen's bulk density by measuring weight and thickness.

Perform the test for 16 cycles composed of 22 turn each, calculating at the end a worn as a average loss in volume and weight.

The apparatus is basically composed of:

- Cast iron horizontal disc with a speed of 30 rpm and a diameter of 750mm furnished of a 200mm test track to position a specimen.
- Separate control panel with digital revolutions counter with automatic stop after preset revolutions.
- Specimen's holder.
- Adjustable charger used to produce a force of 294 N  $\pm$  3 N on a specimen.

**Power supply:** 230V 50Hz 1PH 800W

**Dimension:** 1500x1000x850 mm

**Weight:** 320 kg approx.

#### ACCESSORIES

**C129-01N** ABRASIVE MATERIAL composed of fused alumina (artificial corundum)  
 Pack of 25 kg



**C129-02**

**C129-02** MEASURER THICKER REDUCTION, composed of dial gauge with anular contact face with a diameter of 8-5 mm and measuring board.

### A113 SKID RESISTANCE AND FRICTION TESTER

STANDARDS: EN 1338, EN 1340, EN 1341, 1342, EN 1339

Used for tests on concrete block pavers, natural stones, and skidding tests on wooden floor.

Technical details: see p. 56



**A113**

#### ACCESSORIES

**A110-11** METAL BASE PLATE.

**A110-13** CLAMPING DEVICE for tests on concrete block pavers (EN 1338); natural stones (EN 1341, 1342); skidding tests on wooden floor (EN 1339).

## VERIFICATION OF FORCE TRANSFER

STANDARDS: EN 12390-4 | BS 1881:115 | DIN 51302

The equipment to perform this test is composed of:



### C155N DIGITAL MEASURING TESTER

CYBER PLUS EVOLUTION TOUCH-SCREEN

This unit reads simultaneously the four values supplied by the electric strain load cell. The values are memorized, automatically elaborated and visualized, to directly supply the various coefficients resulting by the calculations, and printed on laser printer (accessory C128) directly connected via USB to the tester.

The unit, through the wide display, shows to the user the different test procedures, as requested by previously selected specification (EN, BS, DIN).

At the end of the test, the display automatically visualizes the test results, by informing also if the frame under test is conforming to the requirements of the selected specification as regards the stability (axial transmission of the loads, self-alignment of the seat ball etc.).

The digital readout unit is also foreseen of a fifth digital reading channel allowing to perform load calibration tests on compression machines up to 3000 kN capacity.

Supplied complete with kit of 5 cables and connectors for load cell coupling, accessories, carrying case.

**Power supply:** 230V 1ph 50Hz

**Dimensions:** 450x350x160 mm

**Weight:** 8 kg approx.

### C154

## ELECTRIC STRAIN LOAD CELL 3000 KN CAPACITY

Consisting of a strain steel cylinder where four balanced strain gauge bridges are centered to measure the deformation on 4 generatrix in relation with two diameters, orthogonal between them, so that both axial and circumferential deformations can be measured.

The cell incorporates a fifth strain gauge utilized for load measurement calibration tests.

Supplied complete with connectors, cables, calibration certificate.

**Dimensions:** Ø 130 by 200 mm high.

**Weight:** 18 kg approx.

### C154-01 POSITIONING DEVICE

Manufactured with special steel, hardened and rectified, it allows to correctly position the load cell on the lower platen of the compression frame, to carry out the footometer test as described by the Standards.

**Dimensions:** 150x150x50 mm

### C155-05

CALIBRATION PROCESS of the load cell to the digital tester, complete with Matest calibration certificate.

## ACCESSORY (recommended)

### C155-10N SOFTWARE

To download to PC the results with possibility of certificate printout. Supplied on CD Rom for PC installation.



MATEST											
VERIFICATION following BS 1881											
Machine Type	C 059/11			Footometer							C155 Matest
Serial No.	1 ord.Exp.3.255			Verified on							05/01/11
Place / date	Treviso 10/04/11			Load cell							C/PA 3000 kN
Resolution	0.2 Class 1			Verified on							09/02/11
Range from	0 to 2000 kN			Temperature							21.0 °C
UPPER PLATE SELF-ALIGNMENT CHECK Load: 200 kN											
Lean	e1	e1	e2	e2	e3	e3	e4	e4	avg		
A	0.172	-0.078	0.200	0.071	0.185	-0.012	0.190	0.016	0.187		
C	0.166	-0.008	0.186	0.001	0.188	0.004	0.168	0.001	0.187		
B	0.173	-0.070	0.198	0.065	0.181	-0.031	0.193	0.036	0.186		
D	0.181	-0.031	0.151	0.025	0.159	0.045	0.174	-0.019	0.159		
Max-Min	0.0600 Dk		0.0683 Dk		0.0758 Dk		0.0742 Dk				
Avg. R	-0.0464 Dk		0.0406 Dk		0.0014 Dk		0.0042 Dk				
SELF-LOCKING CHECK Load: 200 kN											
Pos.	e1	e1	e2	e2	e3	e3	e4	e4	avg		
A	0.239	-0.261	0.235	0.259	0.187	---	0.188	---	0.187		
C	0.241	0.289	0.233	-0.290	0.189	---	0.185	---	0.187		
B	0.173	---	0.180	---	0.143	-0.203	0.232	0.216	0.185		
D	0.185	---	0.184	---	0.217	0.270	0.138	-0.241	0.187		
dAC	0.046 Dk		0.042 Dk		---		---				
SELF-LOCKING CHECK Load: 2000 kN											
Pos.	e1	e1	e2	e2	e3	e3	e4	e4	avg		
A	1.530	-0.170	2.182	0.168	1.933	---	1.837	---	1.868		
C	2.170	0.165	1.164	-0.143	1.887	---	1.850	---	1.868		
B	1.864	---	1.850	---	1.412	-0.136	2.127	0.140	1.868		
D	1.851	---	1.872	---	2.148	0.148	1.185	-0.146	1.868		
dAC	0.025 Dk		880 0.014 Dk		---		---				

Certificate example

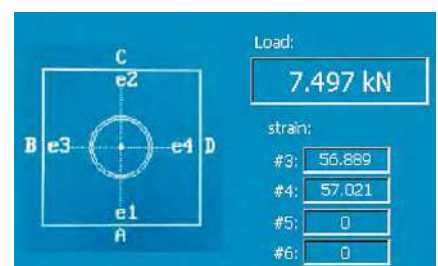



## C138M UNIVERSAL DIGITAL TESTER WITH MICROPROCESSOR FOR LOAD CELLS

CYBER PLUS 8 PROGRESS

STANDARDS: EN ISO 376 | EN 10002-3 | UNI 6326  
 DIN 51220 | NF P18-411  
 ASTM E74 | BS 1610



### MAIN FEATURES

- Up to 5 decimal points visualization.
- LCD display 800x480 pixel.
- Large internal memory for load cell calibrations.
- Lan and RS232 connections.
- Language selection.

This user friendly menu driven digital display, connected to load cells (mod. C140 to C140-10 and mod. C142 to C142-08) allows to perform an accurate verification of the loads measured from machines under control and it allows to produce the corresponding certificate.

The instrument foresees three memorized cycle verification program composed of ten measurements each.

At the end of the test the unit automatically elaborates the stored value and displays:

Effective applied load;  
 Measured load (over three verification cycles);  
 Average measured load;  
 Accuracy in %;  
 Repeatability;  
 Relative readability;  
 Max error.

The tester's accuracy is  $\pm 0.5\%$  of the indicated load.

### TECHNICAL SPECIFICATIONS

#### HARDWARE:

- High resolution converter up to 24 bit.
- Excitation at 5Vcc
- Standard signals: feed + feed - (0V) signal + signal - and shield
- Remote push button to facilitate the readings' confirmation during the calibration and the execution of the cycle of verification.

#### FIRMWARE:

- Software administration up to ten load cells. It can be used one cell at a time, selectable among with the ones correctly configured and installed
- Load measuring range: kN, kg, lb
- Date of test and/or calibration
- Linearization steps or polynomial
- Digital filter of the first programmable order that is able to filter and settle the value acquired by the electrical cell.

#### FUNCTIONS:

- Unlimited execution of verification tests
- Code of the device under verification
- Execution of the verification cycles according to the European EN Standards
- Calculation of all the fundamental parameters required: repeatability and accuracy percentage error, residual error on the 0 point, maximum relative resolution and class of the device under verification
- Sending all the data tests to PC, importable in excel
- Direct USB printer connection (PCL compatible printers)
- Administration of tests by Matcal software (accessory).

#### MAIN PAGE:

- Visualization of all the device data of the selected cell
- Date and time
- Available languages: Italian, English, French, German and Spanish, Polish (other languages on request).

#### SOFTWARE:

To download to PC the results (accessory C155-10N).

Hardware technical details: see p. 18

The apparatus, and all the accessories, is contained in a strong and practical suitcase, immersion resistant with a depressurisation valve.

**Power supply:** 230V 1ph 50-60 Hz

**Dimensions:** 360x300x200 mm

**Weight:** 5 kg approx.

**C138-05** FORCE CALIBRATION PROCESS of one load cell to the digital tester, complete with Matest calibration certificate. EN ISO 376 | EN 10002-3 Class 2

#### ACCESSORY (recommended)

**C155-10N** SOFTWARE  
To download to PC the results with possibility of certificate printout.

### STANDARD LOAD CELLS

TO BE USED WITH THE C138N DIGITAL INDICATOR FOR CALIBRATION OF TESTING MACHINES

STANDARDS: EN ISO 376 | EN 10002-3 Class 2 | ASTM E74 Class A

These load cells are suitable for the calibration of compression testing machines. They consist of a high quality steel block, named sensitive element, where some strains have been fitted: the whole is housed in a stainless steel sheathing. While the load is applied, strains are transmitted to an amplifier (mod C138N) which gives a load digital reading. Further advantages is the possibility to equip different load cells on the same measuring tester and therefore to check all load capacities.

Model	Capacity kN	Dimensions Ø x height mm
<b>C140</b>	25	82x59
<b>C140-01</b>	50	82x59
<b>C140-02</b>	75	82x59
<b>C140-03</b>	100	82x59
<b>C140-04</b>	300	135x160
<b>C140-05</b>	600	135x160
<b>C140-06</b>	1000	135x200
<b>C140-07</b>	2000	135x200
<b>C140-08</b>	3000	135x200
<b>C140-09</b>	5000	180x200
<b>C140-10</b>	500	for tensile tests

#### TECHNICAL SPECIFICATIONS

- Full Scale nominal output: 2 mV/V
- Linearity + Hysteresis:  $\pm 0.3\%$  of full scale
- Repeatability:  $\pm 0.03\%$  of full scale
- CLASS: A



**C140...C142-07**

#### SCREEN EXAMPLE:

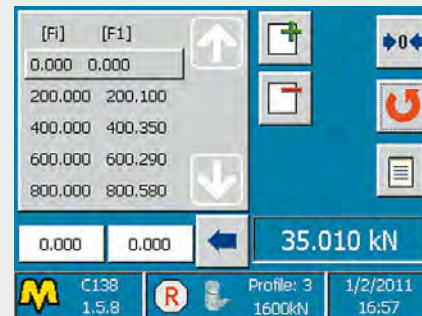

Main Window

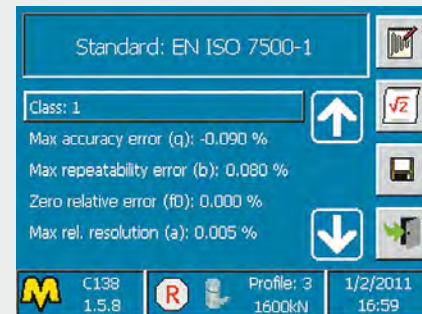

Cell's calibration

### STRAIN LOAD CELLS HIGH PERFORMANCE

TO BE USED WITH THE C138N DIGITAL INDICATOR FOR CALIBRATION OF TESTING MACHINES

STANDARDS: EN ISO 376 | EN 10002-3, Class 1 | ASTM E74 Class AA

These electrical strain gauge load cells of high accuracy and stability, are proposed as an alternative to the standard load cells, for verification and calibrations of high precision, repeatability, and are recommended for a professional use, Metrologic Laboratories, SIT centres. To be used with the Digital Indicator mod. C138N.

Model	Capacity kN	Dimensions Ø x height mm
<b>C142</b>	30	100x127
<b>C142-01</b>	100	105x160
<b>C142-02</b>	300	140x160
<b>C142-03</b>	600	140x160
<b>C142-04</b>	1000	150x200
<b>C142-05</b>	2000	135x200
<b>C142-06</b>	3000	135x200
<b>C142-07</b>	5000	135x200
<b>C142-08</b>	600	tensile/compression

#### TECHNICAL SPECIFICATIONS

- Full Scale nominal output: 2 mV/V
- Linearity + Hysteresis:  $\pm 0.1\%$  of full scale
- Repeatability:  $\pm 0.03\%$  of full scale
- CLASS: AA

#### C138-11 to C138-14

CALIBRATION CERTIFICATE, issued by an Official Calibration Institute (ACCREDIA) for one load cell connected to the digital tester mod. C138N

## TURBO FORCED MIXERS, PAN TYPE WITH VERTICAL AXIS

STANDARD: EN 12390-2

Used to prepare concrete specimens or mixtures, these mixers ensure an uniform, efficient and fast mixture action. They are of easy and practical utilisation, absorb fewer air during mixing and are suitable for laboratory and field purposes.

### TECHNICAL SPECIFICATIONS

- Parallel shaft gearbox (mod. C163, C164, C165)
- Oil bath epicycloidal gearbox (mod. C164-01)
- Wear-resistant steel pan (mod. C163, C164, C165)
- Pan and main parts in wearproof steel (mod. C164-01)
- Safety grid with bag breaker
- Adjustable mixing blades
- Manual discharge mouth on the bottom
- Wheels + tow bar (mod. C163, C164, C165)
- Axle with tire wheels and drive drawbar (mod. C164-01)
- Electric control with magnetothermal overload cutout
- Power supply: 230V 1ph 50Hz (mod C165, C163SP)
- Power supply: 400V 3ph 50Hz (mod C163, C164, C164-01)



**C164-01**

Models		C165	C163/C163SP	C164	C164-01
Pan capacity (volume)	Litres	100	150	200	300
Yeld per mixture	Litres	55	80	135	220
Pan dimensions (Ø x h)	cm	70x30	70x43	80x40	110x40
Motor power	KW	1.1	1.8	4	5.5
Dimensions (Ø x h)	cm	71x115	71x150	110x137	130x135
Weight	kg	115	130	225	420



**C164**

**C163**

**C165**

## C165N PAN TYPE MIXER, HIGH QUALITY

STANDARD: EN 12390-2

This High quality mixer guarantees excellent mixing results particularly using the smallest quantities of material.

High level mixing performances for both mortar and concrete (mixtures up to a grain size of 16mm)

Quick and practical drainage through a valve placed in the base of the drum.

Very long lifespan thanks to a solid and robust construction.

Pan capacity: 100 litres

Mixing amount: max. 60 litres

Pan dimension: Ø 642x310 mm

**Power supply:** 230V 50Hz 1ph

**Dimensions:** 675x825x1215 mm

**Weight:** 162 kg approx.



C165N



C165N Detail

## C162 PAN TYPE MIXER 56 LITRES CAPACITY

STANDARD: EN 12390-2

This multiframe mixer absorbs fewer air during mixing, requires shorter mixing time and grants a perfect homogeneity in mixtures having a low water cement ratio.

The pan is easily removable by means of a trolley (accessory).

The blades are hardened against wear.

Mixing pan: Ø 640 mm x 330 mm deep

Not sellable in CE markets without security cabinet

(see mod. C162-02)

**Power supply:** 230V 1ph 50Hz 2 Hp

**Dimensions:** 800x850x850 mm

**Weight:** 250 kg approx.



C162

C162-01

### ACCESSORIES FOR MOD. C162

**C162-01** TROLLEY for fast and easy removal of the mixing pan of the multi-flow mixer

**C162-02** SECURITY CABINET, manufactured from steel sheet, conforming to CE Safety Directive.

## C161 DRUM TYPE MIXER

Suitable for field mixes of low/medium strength concrete.

Drum volume: 130 litres

Yield: 75 litres of concrete

**Power supply:**

230V 1ph 50-60Hz - 0.3HP

**Dimensions:**

720x1320x1280 mm

**Weight:** 60 kg approx.



C161

## TESTING FRESH SELF COMPACTING CONCRETE (S C C)

ERMCO/EFNARC European Guidelines.

### FREE FLOW AND TIME FLOW DETERMINATION

#### SPRAY-TEST

STANDARD: EN 12350-8

To evaluate the deformability of fresh concrete through free flow, and the time needed to spread a 500 mm diameter.

Applicable to concrete with aggregates of 25 mm max. size

**C181** SLUMP CONE, galvanized steel, to EN 12350-2 Spec.

**C170-01** PLATE, galvanized steel made, dimensions 900x900 mm, with engraved two circles having 210 and 500 mm diameter and central X cross.



### FLOW TIME DETERMINATION V-FUNNEL TEST

STANDARD: EN 12350-9

To evaluate the segregation resistance of self-compacting freshly mixed concrete through the flowing speed from a funnel.

Applicable to concrete with aggregates of 25 mm max. size.

**C171** V-FUNNEL, **stainless steel** made, stand mounted. The upper edge of the funnel is smooth and reinforced, and the outflow orifice is equipped of an openable seal valve. Dimensions: 640x340x1050 mm  
Weight : 20 kg approx.

**C171-11** FILLING HOPPER stainless steel made, to pour the concrete into the funnel in one operation, as specified by the Standard.

**V127** BOX, polythene made, to collect the concrete.

**C262** STRAIGHT EDGE, 460 mm, to level the concrete.

### CONFINED FLOWABILITY DETERMINATION

#### L-SHAPE BOX

STANDARD: EN 12350-10

To determine the confined flowability of self-compacting freshly mixed concrete, and to evaluate the filling and passing ability and segregation resistance.

Applicable to concrete with aggregates of 25 mm max. size.

**C172** L-BOX, **stainless steel** made, consisting of:

- container with inside rigid surfaces,
- obstacle of two different interchangeable set of grids:
- one set of 3 vertical bars having  $\varnothing$  12 mm and free light of 41 mm
- one set of 2 vertical bars having  $\varnothing$  12 mm and free light of 59 mm
- gate in guillotine form

**Dimensions:** 712x280x682 mm

**Weight:** 40 kg approx.

**S200-11** STRAIGHT EDGE, 300 mm long, galvanized steel, to level the concrete.

### CONFINED FLOWABILITY DETERMINATION

#### U-SHAPE BOX

STANDARDS: UNI 11044 | RILEM report N. 23

To evaluate the filling speed and height of the concrete sample under its own self-weight, in the U-shape filling box, to determine the self-compactability. The test is performed with highly fluidised fresh concrete with superplasticiser.

Applicable to concrete with aggregates of 25 mm max. size.

**C173** U-BOX, **stainless steel** made, with inside smooth walls, equipped of a flow obstacle formed by four vertical reinforcement bars. The bars have  $\varnothing$  10 mm and the light between them is 35 mm.  
A gate in guillotine form splits the vertical portion of the box from the horizontal one.

**Dimensions:** 480x250x680 mm

**Weight:** 20 kg approx.

#### S200-11

STRAIGHT EDGE, 300 mm long, galvanized steel, to level the concrete.



## CONFINED FLOWABILITY DETERMINATION

### J-RING APPARATUS

STANDARD: EN 12350-12

To determine the flowability, i.e. the flow time and the capability of the self compacting concrete to pass through obstacles.

#### C174 N

J-RING APPARATUS, galvanized steel made, having rectangular section 30x15 mm and median diameter of 300 mm. The median circumference of the ring is drilled, and n. 16 cylindrical bars  $\varnothing$  18x140 mm are fixed into the holes. The bars have a close distance of 41 mm between them, to simulate a condition of higher density of the reinforced bars.

#### C174-01N

J-RING APPARATUS, similar to C174N, but having n° 12 cylindrical bars and 59 mm distance between them, to simulate a condition of standard density of the reinforced bars.

#### C170

SLUMP CONE, galvanized steel, conforming to EN 12350-2 Spec.

#### C170-01

PLATE, galvanized steel made, dimensions 900x900 mm, with engraved two circles having 210 and 500 mm diameter and central X cross.

#### C183N

### VEBÉ TIME CONSISTOMETER



STANDARD: EN 12350-3

The Vebé consistometer determines the consistency and workability of concrete, based on the same principle of slump test, but with the advantage of a mechanical action. The concrete is subjected to vibration after the cone has been removed, until a transparent disk placed on the material makes completely contact with it. The time required to perform the operation indicates the workability or VE-BE degree. Supplied fully equipped.

**Power supply:** 230V 1ph 50Hz 250W

**Dimensions:** 400x250x690 mm

**Weight:** 100 kg approx.



C183N

C184N



C173

C170

S200-11

C174N

C170-01

#### C184N

### VIBRATING TABLE (Vebé consistometer)

STANDARD: ASTM C1170-14

For determining the consistency and density of roller-compacted concrete. Similar to mod. C183, but conforming to ASTM C1170-14 Spec. with sliding weight of 50 lbs

**\* Power Supply:** 230V 1F 50Hz 180W

**Dimensions:** 280x400x900 mm

**Weight:** 110 kg approx.

**\*Note:** The vibrating table is available also at: 230V 60Hz and 110V 60Hz

#### ACCESSORY for the C184N table

**C184-10N** SLIDING WEIGHT 20 LBS (that replaces the standard 50 lbs one) + base to fix a cylinder mould  $\varnothing$  6"x12" (optional mod. C258-03) to conform the Vibrating Table to the ASTM C1176-14 Specifications.

C258-03

C184-10N

## SLUMP CONE TEST KITS

STANDARDS: EN 12350-2 | EN 12350-8 | ASTM C143  
 BS 1881:102 | AASHTO T119 | NF P18-305

**SLUMP CONE COMPLETE TEST KITS. Matest proposes different versions:**

**C180-KIT** SLUMP CONE, COMPLETE SET, ideal for laboratory tests including:

- C180-01** Slump Cone, **stainless steel** made
- C180-02** Tamping rod, galvanized steel, Ø 16x600 mm
- C180-03** Slump Cone funnel, galvanized steel
- C180-06** Graduated slump scale **engraved in 0.5 cm** increments with sliding measuring rod
- C180-07** Base, galvanized steel, complete
- V184** Aluminium scoop, 500 cc capacity
- V178-01** Fine wire brush

**Weight:** 10 kg approx.



**C178-KIT** PORTABLE SLUMP CONE TEST SET, including:

- C181** Slump Cone, **galvanized steel**
- C179-02** **Graduated** steel tamping rod, galvanized, Ø 16x600 mm
- C179-01** Base, manufactured from heavy duty galvanized steel, complete with clamps and measuring bridge which is also used as carrying handle.  
 The slump is measured using the tamping rod having a graduated scale engraved in 1 cm increments. The components of the set are fitted together for easy carrying. Very practical, robust, ideal for site use.

**Weight:** 8 kg approx.

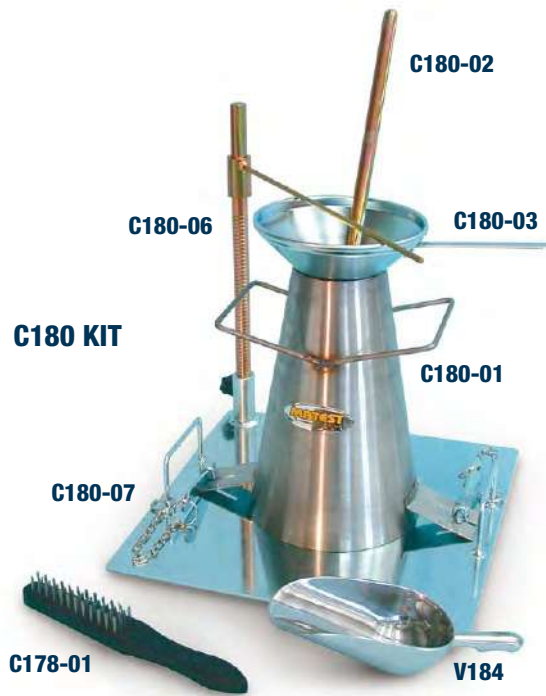

**C182-KIT** SLUMP CONE, COMPLETE SET, including:

- C181** Slump Cone, **galvanized steel**
- C180-02** Tamping rod, galvanized steel, Ø 16 x 600 mm
- C180-04** Base plate, galvanized steel
- V176-01** Stainless steel rule, 300 mm long
- V184** Aluminium scoop, 500 cc capacity
- V178-01** Fine wire brush

**Weight:** 5 kg approx.



**C179-KIT** PORTABLE SLUMP CONE TEST SET, including:

- C180-01** Slump Cone, **stainless steel** made
- C179-02** **Graduated** steel tamping rod, galvanized, Ø 16x600 mm
- C179-01** Base, galvanized steel, complete with clamps and measuring bridge, as described above.

**Weight:** 8 kg approx.

**Note:**

Each component of the kits can be ordered separately. The user can personalize the kit composition for the Slump Cone test.

**C182P KIT****SLUMP CONE, PLASTIC**, complete set including:

- C181P** Slump Cone, **plastic**. Max. temperature: 40 °C  
Weight: 750 g
- C180-02** Tamping rod, galvanized steel, Ø 16x600 mm
- C180-04** Base plate, galvanized steel
- V176-01** Stainless steel rule, 300 mm long
- V184** Aluminium scoop, 500 cc capacity
- V178-01** Fine wire brush

**Weight:** 5 kg approx.**ACCESSORY**

- C180-03P** Cone Filling Funnel, **plastic**. Weight: 250 g

 **Note:** Each component of this kit can be ordered separately.

**C180-01**

**SLUMP CONE** only, manufactured from **stainless steel**, diameter 100/200 mm, height 300 mm, thickness 1.5 mm

**Weight:** 2 kg approx.**C181**

**SLUMP CONE** only, **galvanized steel**, Ø 100/200 mm, height 300 mm, thickness 1.5 mm

**Weight:** 2 kg approx.**V185-03****SCOOP, STAINLESS STEEL**

STANDARD: EN 12350-1

Used to sample fresh concrete

Capacity: 5 kg of concrete

Dimensions: Ø 125x250 mm

**C185****COMPACTING FACTOR APPARATUS**

STANDARD: BS 1881:103

Designed to undertake a more precise and sensitive test procedure than the simple slump test.

The apparatus consists of two conical hoppers mounted on a cylinder. Each hopper has a hinged flange with quick release mechanism and everything is mounted on a rigid steel stand.

The compacting factor is the ratio between the weight of the partially compacted concrete and the weight of the fully compacted concrete. Supplied complete with tamping rod diameter mm 16x600 long.

**Dimensions:** 500x400x1510 mm**Weight:** 55 kg approx.**C192 KIT**  
**FLOW TABLE**

STANDARDS: EN 12350-5 | DIN 1048

The apparatus comprises a galvanneal steel conical mould, Ø 130/200x200 mm, double steel flow table with galvanneal top plane, guide device, wooden tamper.

Used to determine the workability of concrete. The top table has a square surface of 700x700 mm, hinged on one side.

**Weight:** 30 kg approx.**SPARES**

- C192-01** Conical mould, galvanneal steel made, Ø 130/200x200 mm

- C192-02** Wooden tamper



**C187**  
**K-SLUMP TESTER**

STANDARD: ASTM C1362

To determine the degree of compaction and the workability of fresh concrete. Used for in-situ measurements or inside test moulds. Test results can be correlated against the slump values.

**Weight:** 500 g

**C188**  
**WALZ CONSISTOMETER**

STANDARDS: EN 12350-4 | DIN 1048

To measure the consistency of fresh concrete. It consists of a metal box with handles 200x200 mm by height 400 mm, painted for rust protection.

**Weight:** 6 kg approx.

**ACCESSORY**
**V189-01** TROWEL 90x115x165 mm conforming to EN 12350-4

**C189**  
**CONCRETE WORKABILITY METER**

STANDARD: NF P18-452

The concrete workability meter (also known as plastometer) is designed to test concrete for dynamic workability.

It is suitable for field and laboratory tests to check:

- concrete mix for consistency, especially water content
- optimum proportioning of concrete constituents (sand, gravel, water, cement)
- possible improvement when admixing a plastifier
- comparing two concrete types

The unit consists of a prismatic receiver divided into two unequal volumes by a removable partition, and an electric vibrator.

The fresh concrete is poured into the large volume space, the separating partition is removed, and the vibrator starts automatically.

The test consists in measuring the time required for the concrete to reach an uniform distribution in the receivers

**Power supply:** 230V 1ph 50Hz 300W

**Dimensions:** 820x420x410 mm

**Weight:** 80 kg approx.

**C189**
**C186**  
**KELLY BALL APPARATUS**

STANDARD: ASTM C360

Consisting of a hemispherically ended cylinder with guiding frame and a handle graduated in inch, it is used to determine the workability of fresh concrete. The ball is lowered into the concrete and the penetration measured.

It can be used on site or in laboratory.

Cadmium plated for rust protection.

**Weight:** 15 kg approx.

**C186**
**C190**  
**PLASTICITY METER**

Used for quick and easy measurements of the plasticity of mixtures, especially concrete, and so to detect rapidly any excess of water.

The measuring system is related to the shear strength applied by a three blade head to the mixture under test.

It is possible to measure the plasticity at several different points, and directly in the mixture, with multiple checking, and obtained values can be easily compared with the values got by the slump Abrams cone test.

**Dimensions:** Ø 130x180 mm

**Weight:** 2 kg

**C190**

## SETTING TIME OF CONCRETE BY PENETRATION

STANDARDS: ASTM C403 | AASHTO T197 | UNI 7123

### C213 CONCRETE PENETROMETER

Used to determine the setting time of the mortar fraction in concrete mixes with slump greater than zero, by testing mortar sieved from mix. The apparatus consists of a spring penetrometer (capacity 100 kgf, precision 1 kgf) and six interchangeable stainless steel needle pointers of 16-32-65-160-325-650 mm<sup>2</sup> area. A sliding ring indicates the reached load on the handle of the penetrometer. Supplied complete with carrying case.

**Dimensions:** 450x160x70 mm

**Weight:** 5 kg approx.



C213

### C194 CONCRETE POCKET PENETROMETER

Used for the evaluation of the initial set of the concrete mortar. The penetration plunger has a tip area of 32 sq/mm. It is plunged into the mortar to a depth of 25.4 mm, indicated on the plunger. The resistance expressed in Kpa and Lbf/sq.in. is shown on the marked direct-reading scale.

**Dimensions:** Ø 25x210 mm

**Weight:** 400 g



C194

### C194-01 CONCRETE POCKET DIAL PENETROMETER

To evaluate the initial set of concrete, and the effect of the retarders in the setting time.

The plunger has Ø ¼" (32.3 sq.mm.); the dial has dual scale: 0-700 p.s.i. and 0-50 kg/sq.cm.

Supplied complete with plastic case.

**Weight:** 300 g approx.



C194-01

### C211 JOISEL APPARATUS Ø 140X220 MM HIGH

STANDARD: LCPC French Method

Used to separate the various elements of the fresh concrete such as cement, sand, aggregates. All made from stainless steel.

**Weight:** 2 kg



C211

### C220 WATER TEST SET FOR CONCRETE MIXING WATER

STANDARDS: EN 1008 | EN 206 | DIN 4030

This kit, utilized to test the water mixing concrete, is composed by different dropping bottles, water-proof colors scales, test strips. It is suitable, to carry out more than 50 analysis of: total or momentaneous pH, magnesium, ammonium, chloride, sulphate, lime dissolving CO<sub>2</sub>, carbonate hardness, total hardness etc. Contained in carrying cases.

**Weight:** 2 kg



C220

**C195**  
**AIR ENTRAINMENT METER, WATER COLUMN TYPE**

5 LITRES CAPACITY

STANDARDS: EN 12350-7 | ASTM C231 type A

Made from cast aluminium alloy. It records directly the percentage of air enclosed in freshly mixed concrete by operating according to the air pressure principle.

The instrument is supplied complete with pressure gauge tamping rod and hand pump.

Air content range 0...8% - div. 0.1%

**Dimensions:** Ø 250x700 mm

**Weight:** 13 kg approx.

**ACCESSORY**
**C195-01**

CALIBRATION CYLINDER to check and calibrate the air meter mod. C195

**C195**
**C195-01**
**C198**  
**AIR ENTRAINMENT METER, PRESSURE GAUGE TYPE**

7 LITRES CAPACITY

STANDARDS: EN 12350-7 | ASTM C231 type B | AASHTO T152

It consists of an aluminium cylindrical vessel with airtight cover assembly incorporating an air pump, a precision pressure gauge 90 mm dia. and valves.

Capacity: 7 litres.

Air content range: 0 - 100%

Gauge graduations: 0.1% up to 6% of the scale; 0.2% from 6% to 10% of the scale. Lightweight, compact and durable, this meter allows quick clamping system and testing with few pump strokes. It is not affected by change in atmospheric pressures. The container can be used also for unit weight measures of fresh concrete and aggregates. Supplied complete with calibration kit, accessories, robust plastic carrying case.

**Dimensions:** Ø 250 by 500 mm approx.

**Weight:** 10 kg approx.

**C196**  
**AIR ENTRAINMENT METER, PRESSURE GAUGE TYPE**

8 LITRES CAPACITY

STANDARDS: EN 12350-7 | DIN 1048 | ASTM C231 type B

It consists of an aluminium vessel with built in hand operated pressure pump, connected to the measuring gauge showing directly the air content in percentage.

Air content range: 0...10% div. 0.1% up to 8% and 0.5% over

Dimensions: Ø 250x450 mm

Weight: 12 kg approx.

**C196**
**C197**
**C197**  
**AIR ENTRAINMENT METER, PRESSURE GAUGE TYPE**  
 8 LITRES, ELECTRIC

Identical to mod. C196 but with built in automatic electric air compressor giving air pressure, and keeping it constant all along the test.

**Power supply:** 230V 1ph 50-60Hz

**Dimensions:** Ø 250x450 mm

**Weight:** 14 kg approx.

**ACCESSORY**
**C197-01**

FILLING HOPPER for the air entrainment meters C196 and C197

**C198**

## DENSITY OF FRESH CONCRETE

**C199**

### UNIT WEIGHT MEASURE, 10 LITRES CAPACITY

STANDARD: EN 12350-6

Used to determine the weight per cubic metre of freshly mixed and compacted concrete.

Made from steel, 4 mm thick, with inside radius between wall and base of 20 mm, with machined rim and base.

Inside diameter 200 by height 320 mm

**Weight:** 9 kg approx.



**C199**

## UNIT WEIGHT MEASURES

STANDARDS: Comparable to ASTM C29, C138 | AASHTO T19

Made from heavy steel sheet, they are used to determine the weight per cubic metre of freshly mixed and compacted concrete, and as per ASTM Standards also the air content of fresh concrete.



**C200...C205-01**

**C199T**

### UNIT WEIGHT MEASURE, 9 LITRES CAPACITY

STANDARD: UNI 7122:2008

Bucket for determining the weight per cubic meter of fresh concrete. Made of enamelled steel with handles.

**Inside dimensions:** Ø 240 x h200 mm



**C199T**

## ADMIXTURES FOR CONCRETE, MORTAR AND GROUT.

### DETERMINATION OF BLEEDING OF CONCRETE

STANDARD: EN 480-4

**C199-10**

CONTAINER, having Ø 250 mm by 280 mm height, complete with cover. **Stainless steel manufactured**, it is used for the determination of the relative bleeding of a fresh concrete sample, using aggregates having max. size of 50 mm.

**Weight:** 5 kg approx.

## ACCESSORY

**C199-11**

TAMPER, stainless steel made, Ø 100 mm



**C199-11**

**C199-10**

Models	Capacity Litres	Inside diameter mm	Useful height mm	Sheet thick mm	Weight kg
<b>C200</b>	1	108.3	108.6	3	2
<b>C201</b>	2	108.3	217.1	3	3
<b>C201-01</b>	3	160	149.2	3	3.5
<b>C202</b>	5	187.7	180.7	3	4
<b>C202-01</b>	7	187.7	253	3	5
<b>C203</b>	10	265	181.3	4	7
<b>C204</b>	14	265	253.8	4	9
<b>C204-01</b>	15	265	272	4	12
<b>C205</b>	28	345.6	298.5	5	14
<b>C205-01</b>	30	345.6	319.8	5	15

## CONCRETE FLOW TABLE

STANDARD: ASTM C124

Used to determine the flow of concrete. The apparatus consists of a flow table, stainless steel flow mould, tamping bar.

### MODELS

**C208** FLOW TABLE  
 Hand-operated by crank handle.  
 Table diameter 762 mm  
**Weight:** 100 kg approx.

**C208-01** MOTORIZATION KIT to be connected to the flow table mod. C208 and to get it automatic.  
 Complete with separate control panel and automatic digital drops counter.  
**Power Supply:** 230V 1ph 50Hz 750W  
**Weight:** 15 kg approx.



**C208**

## C216 FOUR CHANNELS THERMOMETER K-TYPE THERMOCOUPLE



Used to automatically measure and store the temperature of concrete casting during the curing phase.

- The thermometer is provided with four inputs to connect separately four K-type thermocouple probes.
- It can measure and store up to four simultaneous different points at selectable sampling intervals from 1 to 3600 seconds.
- Measuring range: from -100 °C to 1370 °C
- Resolution: 0.1 °C
- Reading selectable: °C and °F
- Display size: 52x38 mm with green backlight (ON/OFF)
- **SD memory card capacity 8Gb, USB/SD adapter**
- Microcomputer circuit provides intelligent function and high accuracy.
- Real time SD memory and Datalogger, built-in Clock and Calendar, real time data recorder.
- Innovation and easy operation, after tests execution, just take away the SD card from the meter and plug into the PC; it download all the measured values and the user can make the further data or graphic analysis.
- Automatic temperature compensation and linear compensation for the full range.
- Auto power off if any button is not pressed within 10 minutes.
- Operating conditions: 0 to 50 °C and less than 85% R.H.

**Supplied complete with: 50 meters coil K-type thermocouple, set of 4 probes with male connectors, USB/SD adapter, SD card 8Gb, batteries, carrying case.**

**Power supply:** 6 x 1.5V battery.  
**Dimensions (of the thermometer):**  
 177x68x45 mm  
**Weight:** 500 g approx.



**C216**

### SPARE

**C216-01** K-Type  
 Thermocouple coil (50 meters)

## C214 CEMENTOMETER

For the rapid determination of moisture content in wet cement and concrete.

Fast and easy to use; simply insert the prongs into the material being tested,

Accurate and instantaneous readings, digital portable meter.

Ratio range: 0.35 to 0.70 water/cement.

The unit can store over 150 readings.

Data can be recalled via RS-232 interface to using WIN98 and above.

**Power:** 4AA Batteries

**Weight:** 2 kg approx.

## C214-01 CEMENTOMETER

Same to mod. C214 but with ratio range: 0.25 to 0.5 for low water cement ranges



**C214**

## VERIFICATION OF FLATNESS, PERPENDICULARITY, STRAIGHTNESS AND DIMENSIONS OF MOULDS AND SPECIMENS

STANDARD: EN 12390-1

The appendix of EN 12390-1 Standard calls for a set of instruments to be used for dimensional and tolerance verification of the mould and the specimens got from the same.

### V175-03

VERNIER CALIPER, digital, 153x0.01 mm, for dimensional measurements.

### V175-03CER

VERNIER CALIPER, digital, 153x0.01 mm, for dimensional measurements, complete with Calibration Certificate issued by an Accredited Laboratory (SIT).

in alternative:

### V175-02

VERNIER CALIPER, digital, 200x0.01 mm, for dimensional measurements.

### V175-02CER

VERNIER CALIPER, digital, 200x0.01 mm, for dimensional measurements, complete with Calibration Certificate issued by an Accredited Laboratory (SIT).

### C250-10

RULE RIGHT ANGLE (square), steel made, 150x100 mm, rectangular section.

### C250-12

FEELER GAUGE, comprising a set of strips from 0.05 to 0.50 mm, with blade 100 mm long.

### C250-14

RULE (straightedge), 300 mm long.

### C250-16

GO-NOT GO GAUGE, for 100 mm cube moulds.

### C250-16CER

GO-NOT GO GAUGE, for 100 mm cube moulds, complete with Calibration Certificate issued by an Accredited Laboratory (SIT).

### C250-17

GO-NOT GO GAUGE, for 150 mm cube moulds.

### C250-17CER

GO-NOT GO GAUGE, for 150 mm cube moulds, complete with Calibration Certificate issued by an Accredited Laboratory (SIT).



Dimensional verification



Flatness verification



Go-not go verification

## PLASTIC CUBE, CYLINDER AND BEAM MOULDS **MADE IN MATEST**

These one-piece moulds, very appreciated by the user, are made from hard plastic, strong, light, undeformable; resistant to vibrations shocks and wear. They do not require mounting and dismounting operations, thus saving time and labour. They just require a simple clean and demould oiling before being ready for use again for many times. The specimen is expelled from the mould by compressed air or water.

The moulds: C223, C224, C230L, C230N, C232N, C228, C229 are produced by Matest and have competitive manufacturer prices.

### CUBE MOULDS 150 MM SIDE

The cube moulds 150 mm side can be supplied in three different models, each one with different characteristics and weight.

All the models have a reinforced band on the walls, and the inside surfaces are very smoothed getting easier the specimen's ejection.

Models C223 and C224, Matest made, have also **reinforced corners**, granting an additional resistance, and foresee a **X reinforced band on the base**, improving the strenght of the mould, and allowing the user to give small blows with a rubber heated hammer (mod. V195) by easing the specimen's ejection. All the moulds are supplied with engraved the logo Matest.

All the moulds are also available unbranded, and on request they can be supplied with engraved the customer's logo.

### MODELS

#### C223 **MADE IN MATEST**

CUBE MOULD, 150 mm side, with X reinforced band on the base, and reinforced corners.

**Weight:** 1300 g approx.

#### C223R **NEW**

CUBE MOULD, 150 mm side, reinforced. **Weight** 1200 g ca.

#### C224 **MADE IN MATEST**

CUBE MOULD, 150 mm side, **HIGH DENSITY**, with X reinforced band on the base and reinforced corners. The mould same to mod. C223 is manufactured from **high density mixture** with total weight 1600 g, by obtaining a higher hardness and strength of the plastic material.

- It increases the abrasion resistance, by reducing the wear action.
- It improves the pressure resistance during the specimen's ejection, by reducing mould breakages.
- It ensures a larger number of utilisations (with the same use care).

**Weight:** 1600 g approx.

Detail of the X reinforced band on the base of C223, C224, C232N, C235, C237, C238 models

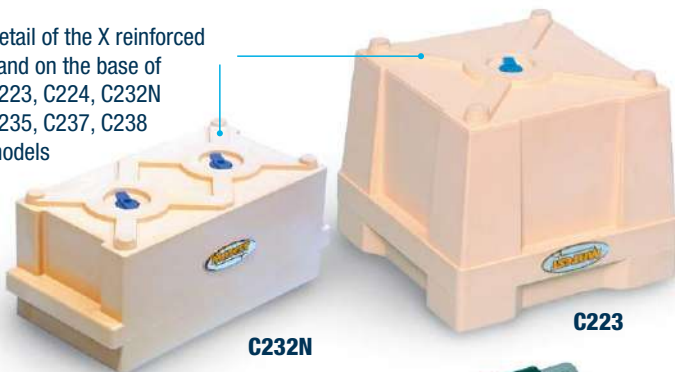

C232N

C223

Reinforced corners



C223 / C224

#### C232N **MADE IN MATEST**

CUBE MOULD, 100 mm side, TWO GANGS, with X reinforced band on the base. The inside surfaces are very smoothed getting easier the specimen's ejection. **Weight:** 1050 g approx.

#### C232

CUBE MOULD, 100 mm side, TWO GANGS, with reinforced corners and band on the walls. **Weight:** 1200 g approx.



C232

C232N

#### C230N **MADE IN MATEST**

CUBE MOULD, standard, reinforced band, 150 mm side.

**Weight:** 1250 g approx



C230N

C230-03

#### C230L **MADE IN MATEST**

CUBE MOULD, 150 mm side, standard, lightweight, entry level price.

**Weight:** 850...950 g approx

**NEW**



C230L

**C235**

CUBE MOULD, 200 mm side, with X reinforced band on the base and upper double reinforced walls and corners.

**Weight:** 2550 g approx.

**C235****C237**

BEAM MOULD, 100x100x500 mm sides, with X reinforced bands on the base and upper double reinforced walls and corners.

**Weight:** 2100 g approx.

**C238**

BEAM MOULD, 150x150x600 mm sides, with X reinforced bands on the base and upper double reinforced walls and corners.

**Weight:** 4400 g approx.

**C228 MADE IN MATEST**

CYLINDER MOULD, Ø 150x300 mm with upper and lower reinforced bands. **Weight:** 2150 g approx.

**C228-01**

CYLINDER MOULD, Ø 100x200 mm with reinforced bands.

**Weight:** 920 g approx.

**C229 MADE IN MATEST**

CYLINDER MOULD, Ø 160x320 mm with upper and lower reinforced bands. **Weight:** 2200 g approx.

**NEW****C228-01****C228****C229****C230-05****C234-03****C223-01****ACCESSORIES**

**C223-01** COVER, plastic, for C223, C224, C230N, C230L moulds. Useful for transportations. Pack of 10 pcs.

**C234-03** STOPPER, plastic, to plug the hole of the moulds C223, C224, C228, C230N, C230L, C229. Pack of 10 pcs.

**C232-01** STOPPER, plastic, to plug the hole of the mould C232N. Pack of 10 pcs.

**C235-01** STOPPER, plastic, to plug the hole of the moulds C228-01, C232, C235, C237, C238. Pack of 10 pcs.

**C230-01** FILLING HOPPER, stainless steel made, for an easier filling of fresh concrete into the moulds: C223, C224, C230, C230N. Supplied complete of clamping elastics.

**C230-03** GRASPING PLIERS for C230 and C230N moulds, to get easier the carriage.

**C230-05** GUN, to connect to a water or air pressure, to eject the specimen from the mould.

**C222-10** COVER, plastic, for C223R and C230N moulds.

**C223-05**

IDENTIFICATION LABEL  
Pack of 250 labels

**C233-05****C231N1****POLYSTYRENE CUBE MOULD 150 MM, ONE GANG**

This cube mould, polystyrene made, is utilized for only one test, because it must be broken when the specimen is demoulded.

It gives different advantages:

- it is provided of a top cover keeping inside heat and humidity constant and acting as a curing room
- it protects the specimen as a packing during transport of the same
- it is extremely light
- any trouble concerning the cleaning, demoulding and maintenance of the mould are eliminated.

Pack of 45 pieces.

**C231N1**



## STEEL CUBE, CYLINDER AND BEAM MOULDS

Nominal moulds dimensions meet to requirements of

STANDARDS: EN 12390-1 | BS 1881:108 | ASTM C192, C39 | AASHTO T23, T126 | NF P18-400

### STEEL CUBE AND BEAM MOULDS

These models of steel cube and beams moulds are extremely sturdy and the inside surfaces are accurately machined.

Nominal dimensions meet to EN 12390-1 requirements.

Cube Mould	Dimensions	Gang	Weight
<b>C247</b>	100 mm side	1 gang.	6 kg
<b>C247-01</b>	150 mm side	1 gang.	13 kg
<b>C247-02</b>	200 mm side	1 gang.	25 kg
<b>C247-03</b>	300 mm side	1 gang.	90 kg
<b>C248</b>	100 mm side	2 gangs.	11 kg
<b>C248-01</b>	150 mm side	2 gangs.	30 kg
<b>C248-02</b>	200 mm side	2 gangs.	45 kg
<b>C248-03</b>	100 mm side	3 gangs.	17 kg
<b>C248-04</b>	140 mm side	3 gangs.	30 kg
<b>C248-05</b>	150 mm side	3 gangs.	38 kg
<b>C249</b>	100 mm side	4 gangs.	20 kg
<b>C249-01</b>	150 mm side	4 gangs.	45 kg



**C247...C249-01**

Beam Mould	Dimensions	Weight
<b>C254</b>	100x100x400 mm	20 kg
<b>C254-01</b>	100x100x500 mm	23 kg
<b>C254-02</b>	150x150x600 mm	44 kg
<b>C254-03</b>	150x150x750 mm	47 kg
<b>C254-04</b>	200x200x800 mm	86 kg
<b>C254-05</b>	140x140x560 mm	38 kg



**C254...C254-05**

### C230-01

FUNNEL (FILLING HOPPER) for an easier filling of fresh concrete into the cube moulds C247-01, C253-01, C253-03. Stainless steel sheet made.



**C230-01**

### STEEL CYLINDER MOULDS

STANDARDS: EN 12390-1 | ASTM C39, C192

AASHTO T23, T126 | NF P18-400

Internal surface, base, top and bottom ring are accurately machined.

Models	Dimensions Ø x height	Weight
<b>C258</b>	100x200 mm	8 kg
<b>C258-01</b>	112.8x220 mm	8 kg
<b>C258-02</b>	150x300 mm	15 kg
<b>C258-03</b>	6" x 12"	15 kg
<b>C258-04</b>	159.6x320 mm	17 kg
<b>C258-04 CO</b>	159.6x320 mm fast clamping	18 kg
<b>C258-05</b>	250x500 mm	80 kg
<b>C258-06</b>	150x150 mm	10 kg



**C258...C258-06**



**C258-04CO**

**CAST IRON SPLIT CYLINDER MOULDS** ➤ NEW

STANDARDS: EN 12390-1 | ASTM C39 | AASHTO T23, T126  
NF P18-400

Cast iron made, heavy duty, they are checked in the shape, dimensions and tolerance with instruments certified by an Official SIT Institute (or equivalent).

Foreseen with fast clamping system with inbuilt revolving screws. They are easy to use with practical and fast demoulding; recommended for field use.

The produced cylinder specimen meet the Standards, by avoiding to the enduser any expensive dimensional verification.

Complete with base, clamp type.

**MODELS****C259-05** ➤ NEW

CAST IRON SPLIT MOULD, to produce a Cylinder Specimen Ø 150x300 mm  
STANDARDS: EN 12390-1 | ASTM C39 | AASHTO T23, T126

**Weight:** 10 kg approx.

**C259-06** ➤ NEW

CAST IRON SPLIT MOULD, to produce a Cylinder Specimen Ø 160x320 mm  
STANDARD: NF P18-400

**Weight:** 11.2 kg approx.



**C180-02...V195**

**CAST IRON CUBE MOULDS, ONE GANG**

STANDARDS: EN 12390-1 | BS 1881:108

These moulds meet the requirements of EN 12390-1 Specifications. They are checked in the shape, dimensions and tolerance with instruments certified by an Official SIT Institute (or equivalent), and have a Serial Number marked on each side.

The produced cube specimens meet the Standards, by avoiding to the enduser any expensive dimensional verification.

Complete with base plate, clamp type.

Two models are available:

- four part wall equal design
- two part wall "V" shaped



Models	Description	Weight kg
C253	Cube Mould 100 mm <b>four part</b>	8.3
C253-01	Cube Mould 150 mm <b>four part</b>	15.5
C253-02	Cube Mould 100 mm <b>two V shaped part</b>	8.3
C253-03	Cube Mould 150 mm <b>two V shaped part</b>	15.5
C253-06	Cube Mould 200 mm <b>four part</b> <span style="color: red;">➤ NEW</span>	27.0

**ACCESSORIES FOR MOULDS**

- C180-02** TAMPING ROD, Ø 16 mm x 610 mm long.
- C261** TAMPING BAR, 25 mm square area x 380 mm long.
- C262** STRAIGHT EDGE, 460 mm long.
- V178-01** WIRE BRUSH, used to clean moulds.
- C265** DEMOULDING OIL. Can of 25 litres
- V184-01** ROUND ALUMINIUM SCOOP 1000 ml capacity
- V187** TROWEL STAINLESS STEEL 120x260 mm
- V195** RUBBER MALLET, head Ø 55 mm
- V182** MIXING TRAY, galvanized 600x600x80 mm

## VIBRATING TABLES

STANDARDS: EN 12390-2 | BS 1881:108

Used for the compaction of concrete specimens in laboratory, they are manufactured from rugged steel sheet.

Equipped with motor-vibrator having 3000 vibrations-minute, it is possible to vary the vibration intensity by acting on the excentric masses.

The height of the table is 410 mm.

All the vibrating tables accept the clamping device, pedal switch or control panel (see accessories).

**Power supply:** 230V 1ph 50Hz

Models	Table dimensions mm	Power W	Weight kg	*Clamping device
<b>C278</b>	600x400	180	60	C281-01
<b>C278-01</b>	800x400	180	85	C281-02
<b>C278-02</b>	800x800	180	115	C281-03
<b>C279</b>	1100x550	180	145	C281-04

\* The clamping device is used to fix the moulds to the table during the vibrating action.

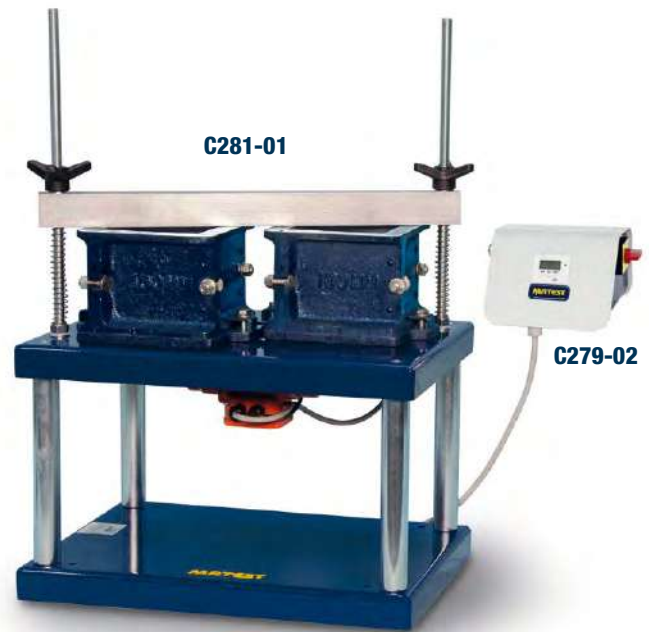

**C278 with moulds C253-01**



**C279**



**C281N**

## PORTABLE VIBRATING TABLES

Similar to the above Vibrating Tables, suitable for site and laboratory use, they accept ONE GANG cube moulds (max. 200 mm side) or cylinders max. 160x320 mm, both plastic and metal made.

**Table dimensions:** 400x300 mm, height 200 mm

**Weight:** 16 kg approx.

### MODELS

#### C281N VIBRATING TABLE, PORTABLE, 12V DC

Suitable for site use, where no electric supply is available.

Lightweight and small sized, it can be handled by one person and easily stored in the car trunk.

Supplied complete with On/Off switch and connector for the vehicle cigar lighter, and elastic bands to fix the mould to the table.

#### C282 VIBRATING TABLE

Similar to mod. C281N, but for laboratory use

**Power supply:**

230V 1ph 50Hz 110W



**C282**



**C282**

## ACCESSORIES FOR VIBRATING TABLES

- C279-04** PEDAL SWITCH, water tight. It can be fixed to the table **only as an alternative** to the Control Panel mod. C279-02
- C279-02** CONTROL PANEL, separate, complete with On/Off switch and timer, getting also the tables to CE Safety Directive. It cannot be used with the table mod. C281N
- C281-05** CLAMPING DEVICE, to fix the mould to the table, suitable **only** for tables mod. C281N and C282. Alternative solution to the elastic bands. Recommended for the laboratory table C282
- C279-01** MOTOR-VIBRATOR, additional, (only for table mod. C279) to obtain an unidirectional vibration and a vibrating power of 300 kg of mass.

## POKER VIBRATORS

STANDARDS: EN 12390-2 | ASTM C31, C192 | AASHTO T23, T126  
Suitable for the internal compaction of concrete specimens both in laboratory and in site.

The diameter of the needle must not exceed the 25% of the smallest dimension of the specimen.

Different models available: electric, petrol, battery operated.

### C271N

POKER VIBRATOR, portable, petrol operated.  
Honda motor, 4-stroke, 1.6HP, 35,8cc  
Tip dimensions: Ø 25 mm by 250 mm long.  
Flexible shaft: 2 metres long.  
Frequency: 10000 vibrations/min.  
Supplied complete with knapsack.

**Weight:** 7 kg approx.



C271N

### C272



POKER VIBRATOR, portable, electric.  
Tip dimensions: Ø 25 mm by 290 mm long.  
Flexible shaft 2 meters long.  
Frequency: 12000 vibr./minute.  
Amplitude: 0.65 mm  
Centrifugal force: 0.8 kN (80 kg)

**Power supply:** 230V 1ph 50/60Hz 2300W

**Dimensions:** 180x350x220 mm approx.

**Weight:** 9 kg approx.



C272

## SPARES

- C272-10** TIP, Ø 25 mm by 290 mm long, complete with flexible shaft 2 metres long, for the vibrator mod. C272.
- C271-10N** TIP, Ø 25 mm by 250 mm long, complete with flexible shaft 2 metres long, for the vibrator C271N



C274M-KIT

### C274M-KIT



POKER VIBRATOR, battery operated, original Makita,

Tip dimensions: Ø 25 mm by 250 mm long.

Flexible shaft: 800 mm long

Frequency: 13000 vibr./minute

Battery power: 18V 3.0Ah

Supplied complete with rechargeable battery and battery charger, original Makita.

**Weight:** 3 kg approx.

## ACCESSORY

- C274-03M** CARRYNG CASE for Makita vibrator and accessories.

## SPARES

- C274M** Poker Vibrator, **without** battery and charger.
- C274-01M** Battery Charger, original Makita.
- C274-02M** Rechargeable battery, original Makita.

## CURING TANKS FOR CONCRETE SPECIMENS

STANDARDS: EN 12390-2 | ASTM C31, C192 | AASHTO T23

### C302 KIT

#### CURING TANK 650 LITRES CAPACITY

HEAVY PLASTIC

Made from extremely robust and stable polyethylene, complete with base rack.

Supplied **without** thermostat heating system, to be ordered separately (see accessories).

**Inside dimensions:** 1040x1040x605 mm

**Weight:** 60 kg approx.



### C302-10 KIT

#### CURING TANK, 550 LITRES CAPACITY

HEAVY PLASTIC

Same to mod C302 KIT but having:

**Water discharge cock incorporated into the tank**

**Inside dimensions:** 1100x710x690 mm

**Overall dimensions:** 1200x80x850 mm

**Weight:** 55 kg approx.



### C304

#### CURING TANK 1000 LITRES CAPACITY

Made from steel sheet, zinc coated to prevent it from corrosion.

Complete with base rack and stopper for an easy water discharge.

Supplied **without** thermostat heating system, to be ordered separately (see accessories).

The tank can accommodate up to 64 cubes 150mm side, or up to 48 cubes 200mm side.

**Inside dimensions:** 1500x750x750 mm

**Weight:** 120 kg approx.



### NEEDED ACCESSORY

Available in two versions:

**C302-01** THERMOSTAT ANALOGIC HEATING SYSTEM, for the tank mod. C302 KIT  
230V 1ph 50-60Hz 2000W

**C304-01** THERMOSTAT ANALOGIC HEATING SYSTEM, for the tanks mod. C302-10 KIT and C304  
230V 1ph 50-60Hz 2000W

AS AN ALTERNATIVE

**C304-02** THERMOSTAT DIGITAL HEATING SYSTEM for the tanks mod. C304 C302-10 KIT and C302 KIT, **ensuring better temperature accuracy**  
230V 1ph 50-60Hz 2000W

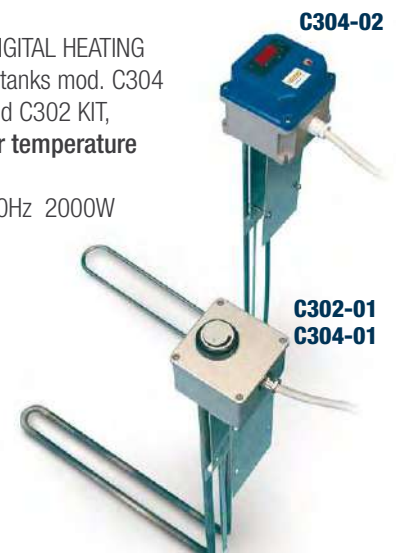

## ACCESSORIES FOR CURING TANKS

- C305-01** PLASTIC COVER for the C302 KIT tank  
**C302-11** PLASTIC COVER for the C302-10 KIT tank  
**C306-04** STEEL ZINC COATED COVER for the C304 tank  
**C306-01** UPPER RACK for the C304 tank to store cubes max.150 mm  
 Max. 8 racks per tank  
**C306-02** SUBMERSIBLE WATER CIRCULATING PUMP, also used for  
 an easy water discharge from the tank 230V 1ph 50/60Hz  
**C306-03** SEPARATE CONTROL PANEL, complete with switch and  
 electric protections, to get the tanks to CE Safety Directive



### C306-05 ANALOGIC THERMOSTAT

Complete with heating element. Used to thermostate any type of tank from 300 to 1000 litres capacity.

**Power supply:**  
230V 1ph 50-60Hz 2000W



E141

### E141 WATER REFRIGERATOR

It cools the water from room temperature up to +10 °C. It is connected to the tank where a lower temperature than the room one is required. See Section "E" Cement, p. 411

### C307 ACCELERATED CONCRETE CURING TANK

STANDARDS: ASTM C684 | BS 1881:112

This tank has been designed for accelerated concrete strength curing. It comprises a fully insulated double wall tank with cover, inside all from stainless steel, outside from steel painted sheet with an intermediate layer of insulating mineral wool.

This tank can hold up to 16 cubic 150 mm side specimens; or 16 cylindrical Ø 150 mm specimens; or 8 cubic 200 mm side specimens. The test consists essentially in curing the concrete specimens with water heated by 3 electric elements of 1500W each.

Temperature range: from ambient to 100 °C.

The separate control panel is provided with a thermoregulator, timer, pilot lights, main switch.

**Inside dimensions:** 910x660x680 mm

**Overall dimensions:** 970x720x900 mm

**Power supply:** 230V 1ph 50-60 Hz 4500W

**Weight:** 130 kg approx.

## EQUIPMENT TO PREPARE A TEMPERATURE AND HUMIDITY CONTROLLED ROOM

The following equipment are suggested as alternative to the curing tanks and climatic chambers indicated in this catalogue or by necessity of a wide area for curing a big quantity of specimens. They are suitable to prepare an already existing room/box or one to be realized by the customer. The temperature of the room can be only increased compared to the external temperature but not decreased.

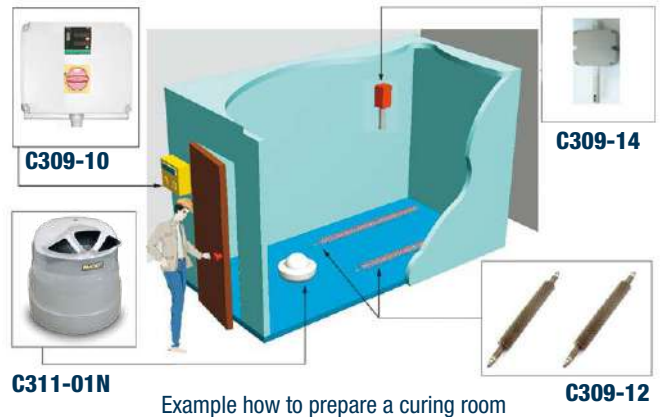

Example how to prepare a curing room

## NEEDED DEVICES

- C309-10** CONTROL PANEL of temperature and humidity.  
 It is usually placed on the outer side of the room, and allows to set, display and control the desired parameters of temperature and humidity.  
**Power supply:** 230V 1F 50-60Hz  
**Dimensions:** 240x130x310 mm **Weight:** 5 kg
- C309-12** HEATING RESISTANCE in tubular frame, finned type.  
 Normally one heating resistance is enough for its purpose, provided that the range between the external and internal temperature set in the room (anyway well insulated) is kept within 15 °C.  
**Dimensions:** Ø 40x1100 mm **Weight:** 2000 g approx.
- C309-14** SENSOR PROBE to measure temperature and humidity.  
 Temperature measuring range from -10 to +90 °C and humidity up to 100%. It is fixed inside the room and connected to the control panel.
- C311-01N** VAPORISER  
 Used to humidify curing rooms up to 80 cubic/metre.  
 Technical data: see p. 350



C307

## CLIMATIC CABINETS



The climatic cabinet is available in two versions:

- **C313N** Temperature and humidity controlled from -30 to +70 °C and 20% to 95% respectively for testing concrete, cement, aggregates and many other applications.
- **C316N** Only temperature controlled from -30 to +70 °C for the determinations of the behavior and resultance to freezing and thawing of aggregates and different other applications on concrete and building materials.

### MAIN FEATURES

- Real-Time display of temperature and humidity parameters.
- High quality thermal insulation material.
- Temperature control from -30 to +70 °C with high stability ( $\pm 0.15$  °C).
- Humidity control from 20% to 95% with  $\pm 5\%$  stability and  $\pm 1\%$  accuracy (within temperature +10 to +70 °C).

### C313N TEMPERATURE AND HUMIDITY CONTROLLED CABINET 535 LITRES CAPACITY

STANDARDS: EN 196-1, EN 1367-1, EN 12390-9

Designed for all research and control laboratories to perform: cold and/or hot temperature measurement at controlled humidity conditions, any kind of freezing/thawing tests and accelerated curing tests. Used to cure concrete and cement specimens and analyze the behavior to freezing and thawing of aggregates and concrete. Internal and external frame is made of stainless steel AISI 304. Polyurethane insulation: 60 mm thick.

Internal ventilation.

Door with 180° opening angle, equipped magnetic gasket and integrated heater against freezing.

Shelves can be taken off and adjustable in height; adjustable feet.

Temperature and humidity sensors wall mounted inside cabinet. The cabinet is supplied with a **two stage filter**; mechanic and mixed ionic/cationic resins. It works with demineralized, softened waters, or tap water with hardness rate up to 300 PPM assuring an excellent functioning along the time.

Equipped with microprocessor temperature/humidity controller with integrated cycles multiple segments programmer.

- panel mount 144x130 mm format
- 5" color graphic display
- 50 programs with 100 segments and real time clock
- Logging function with PC interface (optional)

Visual alarm for minimum and maximum temperature

Supplied complete with 3 adjustable shelves suitable to withstand weights up to 40 kg

**Inside dimensions:** 590x670x1360 mm

**Overall dimensions:** 710x820x2080 mm

**Power supply:** 230V 1ph 50-60Hz 2570W

**Weight:** 170 kg approx.



**C313N**

### C313-01N TEMPERATURE AND HUMIDITY CONTROLLED CABINET 1200 LITRES CAPACITY

Same as C313N model, but with an internal capacity of 1200 liters. Internal ventilation. Door with 180° opening angle, equipped magnetic gasket and integrated heater against freezing.

Shelves can be taken off and adjustable in height; adjustable feet.

Temperature and humidity sensors wall mounted inside cabinet

Visual alarm for minimum and maximum temperature

Supplied complete with 6 adjustable shelves suitable to withstand weights up to 40 kg.

**Inside dimensions:** 1300x670x1360 mm

**Overall dimensions:** 1500x820x2080 mm

**Power supply:** 230V 1ph 50-60Hz 2900W

**Weight:** 230 kg approx.

#### Note:

as far the C313N and C313-01N performances, the humidity range indicated in the product description may be narrower vs. the given interval depending on the selected temperature. Please contact our sales team to investigate the suitability for your requirements.

## C316N TEMPERATURE CONTROLLED CABINET

535 LITRES CAPACITY

STANDARDS: EN 1367-1

Technical specifications:

Same as mod. C313N, except for the humidity control that is not included.

### ACCESSORIES

**C313-11N** ADDITIONAL BASKET SHELVE : Made of Stainless Steel grid, suitable for loads up to 40 Kg.

**C313-12N** MOBILE TEMPERATURE PROBE: Type PT100 in stainless steel bulb for free positioning in the chamber and on the specimen.

**C313-13N** LOGGING FUNCTION: Logging upgrade function for on-board Jumo controller with enabling of "real time trend" and "Historical trend" of variables and predisposition of PC interface.

**C313-15N** PC INTERFACE: Consist of Cables, PC interface converter and Jumo software for editing and real-time view.

## ADHESIVES FOR TILES



DETERMINATION OF TENSILE ADHESION  
STRENGTH FOR CEMENTITIOUS ADHESIVES  
STANDARDS: EN 1348 | EN 12004

## C313-05N INTERNAL FLOODING SYSTEM

Applicable only to temperature and humidity controlled cabinets C313N, C313-01N.

Used for the determination of tensile adhesion strength for cementitious adhesives.

It is composed of two stainless steel vessels and a discharging system for the water.

The system allows to empty and fill the inner vessel with water without opening the climatic cabinet.

Inner vessel water level is limited by a sensor.

Filling and drainage of water are regulated by a valve positioned on the bottom of both vessels.

Inner vessel volume is 150 l, while outer vessel volume is 170 l. Water temperature range is from 10 °C to 40 °C, demineralized water must be used.

Temperature stability:  $\pm 2$  °C

Water pressure range is from 0.2 to 5 bar.

Flooding system can be installed also in C313N already supplied if returned in Matest factory.

System must work with no organic compounds.

### Outer vessel dimensions:

816x588x600 mm

Weight: 50 kg approx.



C313N + C313-05N



Control panel



Two stage filter



## UNBONDED CAPPING PADS AND RETAINERS

STANDARDS: ASTM C1231 | AASHTO T22, T851

Used for compression tests on concrete cylinder specimens, as an alternative method to the sulphur capping and grinding machine. Two steel capping retainers are applied on the two flat surfaces of the cylinder.

Two neoprene pads are put between them, for a better load distribution.

The neoprene pads are available in two models:

- 60 shore hardness pads for expected strength from 10 to 48 MPa
- 70 shore hardness pads for expected strength over 48 MPa

The system is not applicable for expected strength lower than 10 Mpa

The couple of retainers + neoprene pads have a total thickness of 46 mm. Therefore the testing chamber of the press must have more vertical clearance than the height of the specimen + 46 mm.

### MODELS

**C107-09** CAPPING RETAINERS (couple) for Ø 100x200 mm cylinders.

**C107-10** CAPPING RETAINERS (couple) for Ø 150x300 mm and 6"x12" cylinders.

**C107-12** CAPPING RETAINERS (couple) for Ø 160x320 mm cylinders

**C107-18** NEOPRENE PADS (couple) 60 shore A for Ø 100x200 mm cylinders

**C107-19** NEOPRENE PADS (couple) 70 shore A for Ø 100x200 mm cylinders

**C107-20** NEOPRENE PADS (couple) 60 shore for Ø 150x300 mm and 6"x12" cylinders

**C107-21** NEOPRENE PADS (couple) 70 shore for Ø 150x300 mm and 6"x12" cylinders

**C107-25** NEOPRENE PADS (couple) 60 shore for Ø 160x320 mm cylinders

**C107-26** NEOPRENE PADS (couple) 70 shore for Ø 160x320 mm cylinders

**C107-29** NEOPRENE SHEET (couple) 60 shore A dimensions: 600x400x12 mm for test on blocks.

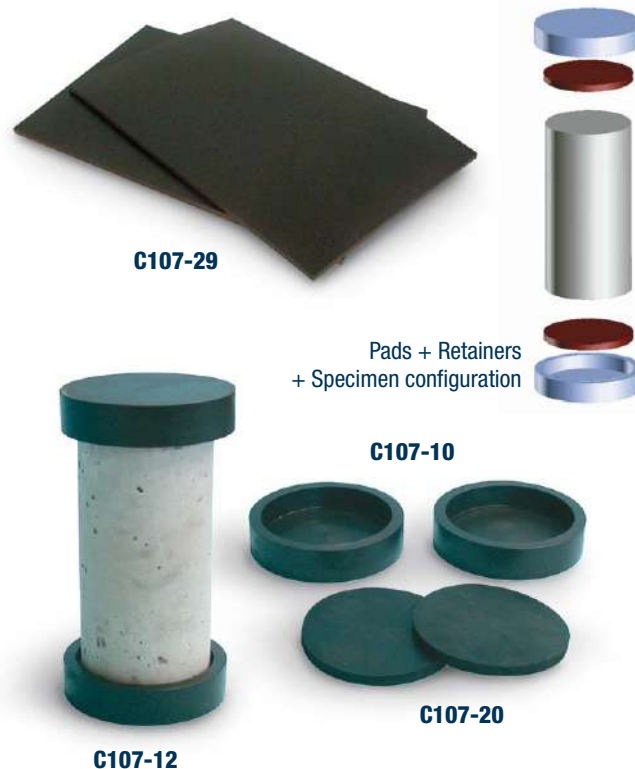

### C312-02 CURING ROOM VAPORISER UP TO 280 M<sup>3</sup>

Same as mod. C311-01N, but more powerful for rooms up to 280 cubic/metre capacity.

Supplied complete of **level regulator** with antioverflow, that allows the direct connection to the water net, for a continuous use of the vaporiser.

**Power supply:** 230V 1ph 50 Hz

**Dimensions:** Ø 420x350 mm

**Weight:** 8 kg approx.



### C311-01N CURING ROOM VAPORISER UP TO 80 M<sup>3</sup>

Used to humidify curing rooms for concrete and mortar specimens. Max. room capacity: 80 cubic/metre.

Supplied complete of **level regulator** with antioverflow, that allows the direct connection to the water net, for a continuous use of the vaporiser.

**Power supply:** 230V 1ph 50 Hz

**Dimensions:** Ø 430x420 mm

**Weight:** 6.9 kg approx.

#### ACCESSORY FOR MOD. C311-01N, C312-02

**C312-10** HUMIDISTAT to automatically control the room humidity, range 30...100 %

#### SPARE

**C312-11** Level regulator, complete of antioverflow.

## CYLINDER CAPPING EQUIPMENT

### SULPHUR METHOD

STANDARDS: EN 12390-3 | ASTM C617, C31, C192 | AASHTO T23, T126 | NF P18-416

The above mentioned Specifications require that the two faces of the concrete core or cylinder specimen must be made perfectly flat and parallel, by using sulphur capping equipment.



**C290-01**

**C290-02**

### CYLINDER CAPPERS

To obtain plane end surfaces perpendicular to the axis of the cylinder.

Model	Cylinder Ø x h	Weight kg
<b>C290-01</b>	150x300 mm, 6"x12"	6.3
<b>C291-01</b>	160x320 mm	6.2
<b>C292-01</b>	100x200 mm	4.4

### C290-02

CYLINDER CARRIER, for Ø 150x300 mm, 160x320 mm and 6"x 12". For an easier handling of the specimens.

**Weight:** 1.4 kg

MELTING POT for capping compound.

Used to melt the sulphur capping compound. Complete with thermometer. Suitable also for general laboratory purposes.

### AVAILABLE MODELS

**C290-03 KIT** MELTING POT, capacity: 4 litres. Inexpensive model. 230V 1ph 50/60Hz 1500W

**A106** MELTING POT, capacity: 5 litres  
Temperature range: +50 to +350 °C.  
accuracy: ± 1.5 °C.  
Complete with pilot lamp, fully isolated to CE Safety Directive. Internal dimensions: Ø 200x160 mm  
230V 1ph 50-60Hz 800W.  
**Weight:** 3 kg approx.



**A106**

**C290-03 KIT**

**V186-01**

### C290-06

CAPPING COMPOUND, ultra strong flake type.

This compound is a mixture of sulphur and mineral filler; the compressive strength of 8000 - 9000 Psi is granted (at two hours) on a 2" cube specimen, as requested by ASTM C617 Standard.

On a Ø 150 mm cylinder the compressive strength is 16000 Psi.

Melting point is 115 to 143 °C. (ideal: 130 °C.)

Bag of 22.5 kg (50 lbs)

**V186-01** LADLE, stainless steel made.



**C290-06**

### OTHER MODELS

**C294-01** VERTICAL CYLINDER CAPPER for Ø 250x500 mm

**C294-02** CYLINDER CARRIER for Ø 250x500 mm

**C294-05** VERTICAL CYLINDER CAPPER for Ø 60x120 mm



**C294-05**

### C296

STEEL CAPPING PLATE, used for capping concrete blocks up to 500x300 mm. The plate surface is accurately machined.

**Dimensions:** 500x300x20 mm

**Weight:** 30 kg approx.



**C296**

**C299**
**AUTOMATIC SPECIMEN GRINDING MACHINE**

STANDARDS: EN 12390-2 | ASTM D4543 | UNI 6132

Designed to grind and polish concrete cube and cylinder specimens, blocks, natural stones, rocks, ceramic materials etc. Specimens are easily fixed to the table by proper locking stirrups (see accessories) allowing to grind at a time:

- n° 3 cube specimens 100 mm side, or
- n° 3 cube specimens 150 mm side, or
- n° 2 cube specimens 200 mm side, or
- n° 2 cylinder specimens Ø 100x200, 110x220, 150x300, 160x320 mm, or
- n° 1 block with max. dimensions 390x250 mm

The radial movement of the head is equipped with end of stroke system, granting the fully automatic displacement in both directions. The column is completely protected against the abrasive dust. The vertical lowering of the grinding head is achieved with infinitesimal adjustments by operating on the top handwheel having 0.05 mm graduations.

The machine, made from rugged plate, is supplied complete with control panel, coolant/decantation tank (by water and emulsifying oil), motor pump, set of abrasive sectors, safety chip guard that when removed, stops automatically the machine.

The standard supply **does not include** the locking stirrups and the diamond sectors (8 pieces) that must be ordered separately (see accessories).

**C299** with **C300-06N** holding one 150 mm cube

**MAIN FEATURES**

- Designed for grinding concrete cube and cylinder specimens, blocks, natural stones, rocks etc.
- Simultaneous grinding of many specimens.
- Motorized radial displacement of the revolving abrasive head in both directions.
- Automatic movements of the head in both directions and controlled by travel limit switches.

**NEEDED ACCESSORIES**

**C300-06N** LOCKING STIRRUPS for cube specimens side 100, 150, 200 mm complete with distance piece 85 mm high.

AS AN ALTERNATIVE

**C299-10**

FAST LOCKING DEVICE, for: cubes 150 and 200 mm; cylinders Ø 100 to 160 mm. Each device accepts only one specimen.

It is possible to grind at a time:

- 1 cube 200 mm;
- 2 cubes 150 mm;
- 2 cylinders.

**C299-10**

**C300-02** DIAMOND GRINDING SECTOR (8 pieces required) **particularly recommended** because of their long duration and good grinding action.

**C300-02**
**TECHNICAL SPECIFICATIONS**

Table dimensions: 775x280 mm (usefull: 750x235 mm)  
 Grinding wheel Ø: 330 mm  
 Vertical span width: min. 175 mm (95 mm with the distance piece) max. 380 mm  
 Grinding height range: 95...380 mm  
 Grinding head stroke: 215 mm  
 Grinding wheel speed: 1400 rpm.

**Power supply:** 400V 3ph 50Hz 2700W  
**Dimensions:** 1220x1080x1730 mm  
**Weight:** 410 kg approx.

## ACCESSORIES

- C300-03** LOCKING STIRRUPS for cylinder specimens  $\varnothing$  100, 110, 150, 160 mm. They can be used only in conjunction with the C300-06N stirrups.
- C300-03SP** LOCKING STIRRUPS for cylinder specimens  $\varnothing$  50 to 100 mm, minimum height 95 mm. They can be used only in conjunction with the C300-06N stirrups.
- C300-05N** LOCKING STIRRUPS for cube specimens side 50 mm to 70 mm. They must be used only in conjunction with the C300-06N stirrups.
- C300-07N** LOCKING STIRRUPS to grind blocks of different sizes, but with max. dimensions of 390x250 mm.



**C300-07N**

- C300-08** CORE FACE PREPARATION DEVICE  
It prepares parallel and flat core faces or rock samples. The device accepts up to 4 core samples from  $\varnothing$  20 to 55 mm and can be mounted on most grinding machines.

**Weight:** 7 kg approx



**C300-05N**



**C300-08**

- C300-09N** DEVICE to collect the produced powder during the drying grinding procedure. The device must be connected to an aspirator (not included).

The four collecting pipes have a max. extension of 3 meters (different extensions on request).

The terminal diameter of the device is: 160 mm

**Weight:** 15 kg approx.

- C300-01** ABRASIVE GRINDING SECTORS, spare, set of 8 pieces.



**C300-09N**



**C299** with **C300-06N** holding 3 cubes 150 mm

## C377 MICRO-CORING EQUIPMENT

STANDARD: UNI 10766

The extraction of a micro-core sample from a concrete structure or masonry is an extremely valid non-destructive method, as it allows analysis and accurate evaluations of the manufacture (compression resistance, ecc.) without causing any damages to the structure, considering the dimension of the hole that can be eventually clogged with mortar.

Micro-coring system is additionally valid and reliable if combined with ultrasonic tester and concrete hammer.

Micro-core extraction is easy and requires the presence of one operator only.

The equipment comprises:

- Suitable electric drill. 230V 1F 50Hz
- Flanged guide assembly
- Drilling mask
- Impregnated diamond bit for cores with  $\varnothing$  28x100 mm
- Impregnated diamond bit for cores with  $\varnothing$  28x200 mm
- 2 Self-blocking pincers to fit the flanged guide assembly to the surface

Set of accessories including: anchors, bits, wrenches, screws.  
Carrying case.

**Dimensions:** 550x400x200 mm approx.

**Weight:** 10 kg approx.



**C377**

### ACCESSORIES

**C377-01** WATER TANK WITH FOOT PUMP, that leaves the hands of the operators free for coring

AS ALTERNATIVE:

**C377-02** AIR-WATER PRESSURE TANK, 10 liters capacity

## C377-05 TRIMMING/CUT-OFF MACHINE FOR CORES

Suitable to cut and trim cores to be prepared for compression tests, where the flatness of both surfaces is a basic condition to obtain correct results.

The equipment is made of stainless steel and aluminum and is supplied complete with diamond blade  $\varnothing$  180 mm.

For this purpose it must be used the drill mod. C377-10 (enclosed into micro-coring equipment) and the water tank with foot pump mod. C377-01.



**C377-05**

### Note:

The maximum values foreseen for compression tests on micro-cores are usually lower than 60 kN. Portable compression machine mod. C094N (see p. 323), or a cement compression tester (see p. 418) may be conveniently used.

Trimming of cores may be even obtained with the grinding machine mod. C299 + device mod. C300-08 (see p. 352)



**C377-02**

### SPARES

**C377-10** ELECTRIC DRILL, suitable for the microcoring purposes.

**C377-15** DIAMOND BIT,  $\varnothing$  28x100 mm

**C377-16** DIAMOND BIT,  $\varnothing$  28x200 mm

## CORE DRILLING MACHINES LIGHTWEIGHT, PORTABLE

These drilling machines are extremely practical, lightweight and easy to use.

The base is from aluminium alloy, the steel column can be tilted up to 45°, the motor support is fixed on a saddle sliding on teflon runner granting high performances. The motor incorporates a water swivel to cool the diamond bit.

The machine is supplied complete, **except** for: diamond bit, spanner, core extractor (see accessories p. 357) to be ordered separately.

### C318N

#### CORE DRILLING MACHINE, ELECTRIC MOTOR

Electric motor at three speeds: 530, 1280, 1780 rpm, with speed reducer, provided of multifunction electronic friction device and switch to CE Safety Directive.

The machine accepts bits diameters from 50 to 150 mm

**Power supply:** 230V 1ph 50-60Hz 2200W

**Dimensions:** 600x320x1020 mm

**Weight:** 24 kg approx.



C318N

C318N tilted

### C324N

#### ELECTRIC CORE DRILLING MACHINE WITH VACUUM FACILITY

The frame and the electric motor are the same as mod. C318N.

The machine is supplied complete with lubricated vacuum pump and pressure accumulation reservoir, which is very useful because it maintains for some times a valid vacuum level also with electric blackout, by avoiding the fall or disconnection of the unit from the wall.

The pump is connected to the utility by means of a ball tap to which a vacuum gage is fitted, that constantly indicates the pressure inside the tank.

Coring angle: 0 to 360° under the condition that the surface is sufficiently flat, and not too porous, to allow the vacuum attachment.

**Power supply:** 230V 1ph 50-60Hz 2200W

**Dimensions:** 600x320x1020 mm + pump

**Weight:** 24 kg + pump 15 kg approx.



C324N

### C332 PORTABLE ELECTRIC GENERATOR

To use with electrically driven machines where electrical power is not available. The generator is rated at 4000 Watt and supplies: 230V 1ph 50Hz.

Complete with tank, accessories.

**Weight:** 60 kg approx.



C332

## ACCESSORY

**C318-10** WATER COLLECTING RING, confining waste water on the surface, for machine mod. C318N and C324N. It has to be connected to a suitable electric pump.

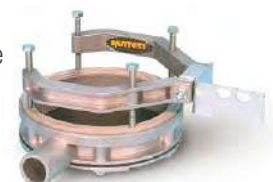

C318-10

## CORE DRILLING MACHINES HIGH PERFORMANCE

These drilling machines are extremely robust, heavy duty, compact and reliable.

The sliding group is rectified in order to assure a very soft and accurate drilling movement.

The drilling excursion is 550 mm and the machine can drill cores up to 200 mm of diameter.

Built in water swivel to cool the diamond bit.

The robust steel base is equipped with wheels for easy site displacements, together with four levelling and stabilizing feet.

All working and moving parts are cadmium plated for rust protection.

The machine is supplied complete **except** for: diamond bit, core extractor and spanner (see accessories) which have to be ordered separately.

### MODELS

#### C319 PAVEMENT CORE DRILLING MACHINE 5HP 4-STROKE PETROL ENGINE

This rugged, compact and portable machine with vertical screw feed, is used for pavement core sampling where it is not easy to get electrical power.

Petrol engine 5 HP power, 4-stroke Briggs & Stratton model.

**Dimensions:** 850x580x1230 mm

**Weight:** 135 kg approx.

#### MAIN FEATURES

- Original Briggs & Stratton motor.
- It can drill cores up to Ø 200 mm.
- Vertical rectified screw feed.
- Built in water swivel to cool the bit.
- Rugged, compact, wheels mounted.



**C319-02**

#### C319-02 PAVEMENT CORE DRILLING MACHINE 12.5 HP 4-STROKE PETROL ENGINE

Same as mod. C319, but activated by a petrol engine 12.5 HP power 4-stroke Briggs & Stratton model.

**Weight:** 150 kg approx.



**C319**

### SPARES

**C331** Petrol engine, for C319 machine 5 HP power, 4-stroke Briggs & Stratton model. Supplied complete with tank, accessories. Weight: 20 kg approx.

**C331-02** Petrol engine for the C319-02 drilling machine. 12.5 HP power, 4-stroke Briggs & Stratton model. Supplied complete with tank, accessories. Weight: 25 kg approx.

## C322 UNIVERSAL ELECTRIC CORE DRILLING MACHINE

Coring angle: 0 to 360°

The excursion group is rectified to assure a very soft and accurate drilling movement. The excursion is 550 mm.

Electric motor at three speeds: 670, 1140, 1580 rpm with speed reducer, provided of friction device and switch to CE Safety Directive.

The height of the vertical column is 1000 mm and is pre-built for extension column connection (accessory mod. C322-01).

**Power supply:** 230V 1ph 50-60Hz 2200W

**Dimensions:** 440x750x1300 mm

**Weight:** 85 kg approx.



**C322**

### ACCESSORY

**C322-01** EXTENSION COLUMN, 1000 mm long, to connect to mod. C322 for drillings over 1 metre from the ground.



## DIAMOND CORE DRILL BITS WITH BACKEND SCREWED CONNECTOR

Designed for making holes and getting cores from hard materials, like concrete, reinforced concrete, rocks, stones, bituminous materials. The diamond utilized for these bits is quality impregnated sinterized type.

The diamond segment is **9 mm high**. The 9 mm high segment is important for the bit life, because the diamond is about 85% of the bit value.

The coupling between the bit and the motor shaft is direct through the backend screwed connector.

This diamond bit model is suitable to drill both reinforced concrete and also bituminous materials.

### Note:

Matest can also provide high-performance diamond core drill bits having the same diameter (models with a HP code) but with a quantity of diamonds greater than 50%, to guarantee even faster and more precise drilling, as well as a longer life.

- C344** Strap wrench useful for unblocking any type of bit.
- C344-01** Strap wrench useful for unblocking only the bits with backend screwed connector.
- C345** Extension rod 300 mm. long (used for deep holes).



**C339-01...C339-05**

Model	HP Model	Outside Ø mm	Inside Ø mm	Bit length mm	Expander Coupling	Core Extractor
C339-01	C339-01 HP	57	50	450	no	C346
C339-02	C339-02 HP	82	75	450	no	C346-01
C339-03	C339-03 HP	108	100	450	no	C346-02
C339-04	C339-04 HP	160	152	450	no	C346-03
C339-05	C339-05 HP	210	200	500	no	C346-04



### C348T SPECIMEN CUTTING MACHINE

with sliding supports.

The machine accepts blades up to  $\varnothing$  400 mm

Useful cutting height: 130 mm

Dimensions of the sliding table: 460x400 mm

Blade rotation speed: 2800 rpm

Supplied **without** blade

(see accessories)

**Power supply:**

230V 1ph 50Hz 3Hp

**Dimensions:**

1185x660x1400 mm

**Weight:**

79 kg approx.



C348T

### C350T SPECIMEN CUTTING MACHINE

Used to cut concrete specimens and any type of construction material like blocks, tiles, pipes, rock cores etc. The machine is equipped of an electro-pump for water cooling, pedal guide for vertical cutting, safety device against breakage of blade.

The machine accepts blades up to  $\varnothing$  450 mm

Useful cutting height: 165 mm

Supplied **without** blade (see accessories)

**Power supply:** 400V 3ph 50Hz 4Hp

**Dimensions:** 1330x600x1370 mm

**Weight:** 128 kg approx.



C350T

### C350-01T SPECIMEN CUTTING MACHINE

Identical to mod. C350T, but with:

**Power supply:** 230V 1ph 50Hz 3Hp

### C349T SPECIMEN CUTTING MACHINE

Basically similar to mod. C350T, but it can accept blade having max.  $\varnothing$  600 mm

Useful cutting height:

230 mm with blade  $\varnothing$  600 mm

**Power supply:** 400V 3ph 50Hz 5.5Hp

### C351 SPECIMEN BENCH CUTTING MACHINE

The machine accepts blades up to  $\varnothing$  350 mm

Useful cutting height: 120 mm

Blade rotation speed: 3900 rpm

Supplied complete with abrasive blade  $\varnothing$  350 mm

**Power supply:** 230V 1ph 50Hz 2000W

**Dimensions:** 560x460x390 mm

**Weight:** 20 kg approx.

#### ACCESSORIES

**C350-12** DIAMOND BLADE  $\varnothing$  450 mm, having long life for a faster and more precise cutting operation. Suitable for models C350T and C350-01T.

**C350-13** DIAMOND BLADE,  $\varnothing$  350 mm for mod. C351

**C350-14** DIAMOND BLADE,  $\varnothing$  400 mm for mod. C348T

**C350-17** DIAMOND BLADE,  $\varnothing$  600 mm for mod. C349T

**C350-10** ABRASIVE BLADE  $\varnothing$  350 mm for mod. C351

 **Note:**

It is recommended to use the blade having the max. diameter accepted by the cutting machine.

**C352**

DEVICE FOR CYLINDERS AND CORES

To clamp and cut cylinders and cores diameter 100 to 160 mm.

The device is fixed to the table of the cutting machines mod. C348T, C350T, C350-01T, C349T. Weight 10 kg approx.



C351

**C352 SP**

DEVICE FOR CORES, as above, but  $\varnothing$  55 to 160 mm.

**C353**

DEVICE FOR IRREGULAR SHAPES

To clamp and to cut irregular shaped specimens, like rocks, stones etc. The device is fixed to the table of the cutting machine mod. C348T, C350T, C350-01T, C349T.

Weight: 5 kg approx



C353

## MECHANICAL STRAIN GAUGES

STANDARDS: ASTM C426 | BS 1881:206

Used to determine the strain (length changes) in concrete specimens and structures, rock strata, different parts of a structure, in remote areas and under adverse conditions, using a single instrument. Different models are available with analogic or digital gauge, 100, 200, 300 mm measuring length, depending on the standard length to be measured. The instrument can also be used for other structures like steel and wood.

The KIT comprises:

- Strain gauge (extensometer) complete with analogic or digital indicator 0.001 mm graduations (see available models)
- Calibration bar used also to fix the datum disc on the structure.
- 50 datum discs.
- Adhesive compound for datum discs.

The whole contained in carrying case.

MODELS with **analogic gauge** 0.001 mm graduations:

- C360 KIT** STRAIN GAUGE, 100 mm measuring length.  
**C360-01 KIT** STRAIN GAUGE, 200 mm measuring length.  
**C361 KIT** STRAIN GAUGE, 300 mm measuring length.  
**C361-01** STRAIN GAUGE, 600 mm measuring length.



**C361 KIT**



**C363-01 KIT**



**C363 KIT**

MODELS with **digital gauge**, battery feeded, with reading values in mm (sens. 0.001 mm) and in inch (sens. 0.0001"). Complete with battery and RS232 connector to PC.

- C363 KIT** STRAIN GAUGE, 300 mm measuring length.  
**C363-01 KIT** STRAIN GAUGE, 100 mm measuring length.  
**C363-02 KIT** STRAIN GAUGE, 200 mm measuring length.  
**C363-03** STRAIN GAUGE, 600 mm measuring length.

### ACCESSORY for C363 serie models

- S382-13** CABLE to connect S382-01 and S383 to PC through USB port for direct visualization and recording of the measurement.

### SPARES

- C362-01** Datum disc (pack of 50)  
**C362-02** Adhesive compound.

## C399 CRACK DETECTION MICROSCOPE

Used to measure crack width in concrete structures, by operating via an adjustable light source.

High definition unit, provided by power batteries, carrying case. The eyepiece scale can be turned through 360° to align with the direction of the crack under detection.

Measuring range:  
4 mm and div. 0.02 mm.  
Magnification: x35

Weight: 600 g



**C399**

## FLAT JACKS - TESTS ON BRICKWORKS

- DETERMINATION OF RESISTANCE AND DEFORMATION UNDER LOAD
- EVALUATION OF TENSILE STRESS
- MEASUREMENT OF ELASTIC MODULUS AND BREAKING LOAD

The complete test is developed in two steps:

### ■ DETERMINATION OF STATIC LOAD (TENSILE STATUS)

#### One flat jack is used.

Two datum points are fixed across a mortar joint and the distance between the points is measured.

Successively a horizontal cut is carried out with the suitable tool (drill, cutting saw) level with the mortar layer, and it is measured the variation of the two datum points.

The flat jack must be introduced, it is pressurized in different growing phases and the variation between the datum points is measured, by determining the static load.

### ■ DETERMINATION OF DEFORMATION AND RESISTANCE (IN-SITU STRESS)

#### Two flat jacks are used.

It must be done a second cut, parallel to the first one, level with the mortar layer, having a distance of approximately 50 cm from the first cut. Another flat jack must be introduced.

Three couples of datum points are placed on the brickwork portion between the two cuts.

Start to pressurize the two flat jacks at growing phases.

The variation of distances of the datum points at different pressure steps allows to delineate a strength-deformation curve, obtaining elastic modulus, Poisson and breaking point values.

#### C358-01

RECTANGULAR FLAT JACK high deformability, max. pressure 50 bar, dimensions 400x200x4 mm. Steel sheet 0.8 mm thick. Complete with nuts and groins.



#### C358-11

N° 6 STEEL SHEETS, dimensions 400x200 mm, three pieces 1 mm thick, three pieces 1.5 mm thick



#### C358-02

SEMI-OVAL FLAT JACK ad high deformability, max. pressure 50 bar, dimensions 350x260x4 mm. Steel sheet 0.8 mm thick. Complete with nuts and groins.

#### C358-12

N° 6 STEEL SHEETS, dimensions 350x260 mm, three pieces 1 mm thick, three pieces 1.5 mm thick.

#### C358-05

STOPCOCK (valve) high pressure complete with fittings, to close the oil flow in the jack and stop the pressure.

### LOAD APPLICATION

**C358-06** HYDRAULIC HAND PUMP, complete with integral reservoir with oil, to apply pressure to the jacks.

**C358-15** Flexible rubber TUBE, 3 meters length, for the connection to one jack.

or:

**C358-16** Flexible rubber DOUBLE TUBE, 2 and 3 meters length, for the connection to two jacks.

**C358-08** MANOMETER high precision 0 - 60 bar range, with fast jack, to be fixed on the pump to read the applied pressure.



## STRAIN MEASUREMENT

**C361 KIT** STRAIN GAUGE-EXTENSOMETER with mechanical strain gauge, 300 mm length

or:

**C363 KIT** STRAIN GAUGE-EXTENSOMETER with digital strain gauge, 300 mm length

Other strain gauge models with accessories described in detail at p. 359



**C361 KIT**

As alternative to the strain gauge, the data acquisition and processing system can be used, with the following equipment:

### C358-21

ELECTRONIC EXTENSOMETER, supplied with linear displacement transducer having 10 mm stroke and 0.1% linearity, fitted in a tubular anodized aluminum frame, complete with electrical cable and connector .

Span: 300 mm

**Weight:** 300 g approx.



### C358-23N

PRESSURE TRANSDUCER, 50 bar capacity, to be fitted to the hand pump (as alternative to the manometer).

Complete with fast jack to the pump, electrical cable and connector.

### C405-15M

CYBER-PLUS 8 PROGRESS TOUCH SCREEN

8 Channels acquisition and processing data system, 24 bit resolution. Electronic advanced technology, **display** LCD, TFT, 800x480 pixels, 7", **touch screen**, high graphic performances, the unit automatically performs test and data processing. A certificate can be printed through an external USB printer (optional).

The Cyber-Plus is equipped with LAN port for connection to PC and with USB port for an unlimited memory storage.

Contained in a practical and sturdy watertight carrying case, can be powered from an electrical network 90-270 V or use the internal battery and charger granting one full day on-site use.

Hardware technical details: see p. 18

### S337-51

CALIBRATION process between the electronic extensometer or the pressure transducer to the data acquisition unit C405-15M



**C405-15M**



**C358-21**

Application exemples

## TESTING OF HARDENED CONCRETE

### HYDRAULIC SHRINKAGE DETERMINATION

To measure the axial and/or superficial dimensional shrinkage of concrete specimens during hardening process in a curing room.  
 STANDARDS: UNI 11307 | UNI 6555 (comparable to ASTM C426)

The specimen is prepared by a mould having dimensions 100x100x500 mm, with aggregates up to 30 mm max. diameter, and after housed in the measuring apparatus that determines the axial shrinkage.

The two UNI Standards require two different systems to prepare the specimen:

- The UNI 11307 requires reference pins to be stuck on the specimen.
- The UNI 6555 requires inserts fixed into the mould and let into the specimen.

#### EQUIPMENT ACCORDING TO UNI 11307:

##### C254-01

**BEAM MOULD**, steel made, to prepare a concrete specimen 100x100x500 mm

**Weight:** 23 kg approx.

##### C366-12

**REFERENCE PIN**, to be stuck in the intersection of the longitudinal axis of the specimen with its bases.

Pack of 10



C366-12

#### EQUIPMENT ACCORDING TO UNI 6555 (comparable to ASTM C426):

##### C365

**SHRINKAGE MOULD**, steel made, complete with inserts, to prepare a concrete beam specimen 100x100x500 mm

**Weight:** 23 kg approx.

##### C366-11

**INSERTS**, stainless steel, spares to C365 mould. Pack of 10

#### NEEDED ACCESSORIES, ACCORDING TO: UNI 11307 AND UNI 6555

**C364** MEASURING APPARATUS, for 100x100x500 specimens, complete with reference bar, but **without** dial gauge to be ordered separately. **Weight:** 23 kg approx.

**S375** DIAL GAUGE, 5 mm stroke by 0.001 mm sens.

AS AN ALTERNATIVE:

**S376** DIAL GAUGE, 10 mm stroke by 0.01 mm sens.

AS AN ALTERNATIVE:

**S382-01** DIGITAL GAUGE indicator, with readings in mm (sens. 0.001 mm) and in inch (sens. 0.0001"), battery feeded. Complete with battery and RS232 connector to PC.

**S382-13** CABLE to connect S382-01 and S383 to PC through USB port for direct visualization and recording of the measurement.



DETERMINATION OF RESTRAINED EXPANSION OF CONCRETE OR MORTAR SPECIMENS CONTAINING THE EXPANSIVE AGENT, AND THE EFFECT OF THE AGGREGATES ON THE DRYING SHRINKAGE OF CONCRETE

STANDARDS: UNI 8147 | UNI 8148

The mould, steel made, is supplied complete with 3 screwed rods and 6 restrained end plates.

#### MODELS

**E114** THREE GANG PRISM MOULD, to produce 80x80x240 mm specimens. Weight: 15 kg approx.  
 STANDARD: UNI 8148

**E114-02** Restrained end plate 80x80 mm; spare to E114 mould.

**E115** THREE GANG PRISM MOULD, to produce 50x50x250 mm specimens. Weight: 10 kg approx.  
 STANDARD: UNI 8147

**E115-02** Restrained end plate 50x50 mm; spare to E115 mould.

**E115-01** Steel screwed rod 280 mm long; spare to E114 and E115 moulds.



#### ACCESSORIES

**E078 KIT** LENGTH COMPARATOR, with digital dial to measure linear variations.

Technical details and other models: see p. 397

**E078-05** REFERENCE ROD, 280 mm long

## C376N PULLOUT TEST APPARATUS

STANDARDS: EN 12504-3 | UNI 10157, UNI 9536, comparable to ASTM C900

Used to evaluate the concrete resistance as per the strength applied to extract a disc embedded into concrete.

The standard equipment comprises hydraulic extraction unit 100 kN capacity with pump, precision manometer 0-100 kN, bearing ring, 10 steel discs Ø 25 mm (EN 12504-3), carrying cases.

**Weight:** 18 kg approx.

### ACCESSORIES

**C376-01** INSERTS, 30 mm Ø (UNI 9536) to embed.  
Pack of 25 pieces.

**C376-03** DISCS, 25 mm Ø (EN 12504-3) to embed.  
Pack of 25 pieces.

### DETERMINATION OF POWER EXTRACTION THROUGH INSERTS POST INTRODUCED, WITH FORCED AND GEOMETRICAL EXPANSION

STANDARD: UNI 10157

It's used to determine the needed power to extract from a concrete element a metallic insert that is introduced in the element by perforation.

This extraction power it's used:

- To investigate on concrete mechanic proprieties in site.
- To estimate the in site concrete's compression resistance in a case of specific calibration curve.

The equipment is composed of:

- C376 N** Pullout test apparatus
- C376-10** Connecting rod furnished with bearing ring, to be used with the pull-out instrument to hook the C376-11 insert.
- C376-11** Geometric expansion pull-out insert dia. 18x80 mm. Pack of 10 inserts.
- C376-12** Hardened drill beat to perform a hole as required from UNI standard and to put in a insert.
- C376-13** Drill with SDS mandrin
- C376-14** Striker, to put a insert into the hole
- C376-15** Aspirant pump to clean the hole from detritus and dust



**C376-01**

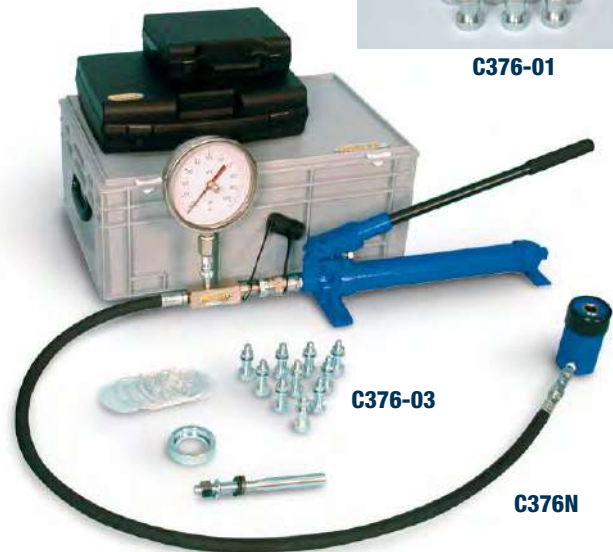

**C376-03**

**C376N**

## E142 DIGITAL PULL-OFF (BOND) STRENGTH TESTER

CAPACITY: 16 KN

STANDARDS: EN 1542, EN 1348, EN 1015-12, EN 13687-2  
EN 13963, 14496 | NF P18-858 | BS 1881:207  
ISO 4624

This dynamometer measures the adhesive force and the tensile strength of two layers of materials (concrete, facing plasters, mortars, building plasters, lime etc.) and is particularly suitable for applications concerning testing repairs of any structure where the bond strength between two layers is an essential factor.

Technical details, more accurate description and accessories: see p. 406



**E142**

## E142-01 DIGITAL PULL-OFF (BOND) STRENGTH TESTER

CAPACITY: 0-5 KN

Identical to mod. E142 but with load cell and digital display range 0-5 kN for more accurate measurements on low strength values. Technical details: see p. 406

**C374**
**MOISTURE METER - SURVEYMASTER**

Used to measure the damp conditions in concrete structures, masonry, gypsum, both on surface and at depth with non-destructive method.

Measuring range: from 7.9% up to the nominal value of the 99% with  $\pm 0.1\%$  accuracy.

Digital reading of values, audible alarm.

Battery operated.

**Dimensions:** 170x54x42 mm

**Weight:** 200 g approx.

**C374**
**C374-06**
**AQUAMETER, UNIVERSAL MOISTURE METER**

This pocket electronic instrument measures the quantity of water in various solid materials such as concrete, masonry, gypsum, brick, woods, mortars etc.

Using a high frequency capacitive sensor, a large volume of material (approx. 50x75x25mm) is sampled instantaneously.

Features:

- Direct read-out of moisture content; no charts or tables required
- Resolution:  $\pm 0.1\%$
- Accuracy:  $\pm 0.2\%$  at constant temperature
- Sensing field volume: approx. 90 cm<sup>3</sup>
- Program mode on concrete, masonry, gypsum, brick, most woods available for maximum accuracy, with special user calibrated mode and averaging function.
- No prongs, probes or holes to be drilled

Typical Applications:

- Locate leaking pipes in walls and floors
- Locate seeping water in basements and masonry tanks
- Check moisture level of materials before applying coatings or adhesives
- Curing condition of wood, stucco and other construction materials

**Powered by:** battery 9 V

**Dimensions:** 110x70x50 mm

**Weight:** 250 g approx.

**C374-06**
**A028**
**CARBIDE METER FOR SURFACE DAMPNES**

For the rapid and accurate determination of moisture content.

The sample is drilled or scraped from the surface and introduced into the bottle with the carbide reagent.

The meter is suitable for moisture tests on sand, aggregates, soil etc.

It is possible to vary the sample weight from 3 to 100 g for the complete reaction between sample and carbide with accurate moisture measurements from 0 to over 20%

The glass ampoule containing the calcium carbide is broken when the bottle is closed and shaken, granting better accuracy to the test.

The instrument comprises the testing bottle with manometer, small balance, 20 ampoules of reagent, accessories, case.

**Dimensions:** 520x340x140 mm

**Weight:** 6 kg approx.

**A028**
**C375-02N**
**CARBONATION TEST**

STANDARD: EN 13295

The test allows the measurement of the depth of carbonation through the surface of concrete.

The set consists of :

- phenolphthalein solution (1000 ml)
- demineralized water (5000 ml)
- depth measuring gauge
- two washing bottles 250 ml capacity

The surface of the concrete specimen under test is sprayed with phenolphthalein solution to detect the loss of alkalinity associated with carbonation. The risk of carbonation induced corrosion can be measured, if correlated with the concrete cover to reinforcement.

**Weight:** 6 kg approx.

**C375-02N**

### C375-01 CHLORIDE FIELD TEST SYSTEM

STANDARD: AASHTO T260, Comparable to ASTM C114

The determination of the chloride ion concentration in concrete is essential in assessing the need for maintenance on, for example, bridge decks and parking structures. The test can also be used to ensure that materials used in new construction are free from potentially harmful chloride ion levels.

With this method, the concentration of acid soluble chlorides is measured. In most cases this is equivalent to total chloride concentration.

#### MAIN FEATURES

- Fast results within minutes at the site
- Low cost per sample compared to laboratory testing
- Accurate results are comparable to laboratory testing
- Covers wide range from 0.002% to 2% chloride by weight
- Automatic compensation for changes in ambient temperature
- Digital display for direct reading of lbs./cu.yd. and percentage of chloride by weight

The test system includes:

- Electronic meter, high impedance with temperature compensation and microprocessor for direct conversion to percentage of chloride. Battery powered.
- Chloride combination electrode with temperature sensor
- 12 jars each with 20 ml of extraction liquid
- 5 jars of coloured calibration liquid
- Scale for 3 g samples weighing, accessories, carrying case

**Weight:** 5 kg approx.

The equipment comprises: manual vacuum pump, digital pressure measuring system, stainless steel chamber for surface measurements, 25 silicone rubber plugs, clamping pliers, drill bits, anchors, accessories. The whole contained in carrying case.

**Dimensions:** 430x300x150 mm

**Weight:** 6 kg approx.

#### SPARE

**C375-03** Pack of 12 jars of 20 ml extraction liquid and 5 jars of colored calibration liquid.

### C375-10 KIT AIR AND WATER PERMEABILITY OF CONCRETE FIGG TECHNIQUE

The ingress of air and moisture into the concrete can cause corrosion of the steel reinforcement and lead to a deterioration in concrete strength.

Therefore, a measure of the ease of movement of liquids and gases through the surface layer of the concrete is a better method of assessing the soundness and expected life of concrete than strength alone.

Permeability is recognized as being the most important parameter in assessing concrete durability.

The depth test is performed by drilling a hole 10 mm diameter x 40 mm deep, and plugged with a silicone rubber plug.

A hypodermic needle is passed into the stopper; the water permeability test is performed by measuring the time of absorption needed by the water introduced into the void by pressure.

For the air permeability test, a vacuum pressure is created in the void, and the time needed to rise this pressure is measured.

Surface permeability tests can be carried out by clamping a stainless steel chamber on the smooth surface of the concrete.

#### SPARE

**C375-11** Silicone rubber plugs. Pack of 25 pcs.



**C375-10 KIT**



**C375-01**



## RAPID CHLORIDE PERMEABILITY OF CONCRETE

### C378N CHLORIDE ION PENETRATION METER

STANDARDS: ASTM C1202, ASTM C1760 | AASHTO T277

Laboratory test device for the measurement of the resistance of the concrete against the penetration of chloride.

The measurement data can be used to estimate the chloride diffusion coefficient of concrete for the service life prediction and design of concrete structures as well as the durability-based quality control of concrete.



**C378N**

#### MAIN FEATURES

The following are unique features of this device:

- Stand alone operation.
- Easy-to-assemble.
- Accurate ( $\pm 0.1$  mA)
- Flexible logging interval time (1 to 10 min)
- Automatic temperature control system.
- Four measurement channels.
- User-friendly PC software.
- Customizable setup.
- USB connection to computer.

#### Applications:

The device can be used for testing the durability of concrete exposed to chloride-contaminated environment including:

- Concrete ability to resist chloride ion penetration (ASTM C1202, AASHTO T277).
- Bulk electrical conductivity of concrete (ASTM C1760).
- Performance-based quality control of concrete.
- Estimation of chloride diffusion coefficient of concrete.
- Estimation of chloride migration coefficient of concrete
- Service life design of concrete structures.
- Estimation of the remaining life of concrete structures.

#### Compliance:

- The only instrument in the market that meets the specifications of ASTM and AASHTO Standard for sample cell.
  - Electrical safety certification mark for use in concrete laboratories.
- Supplied complete with set of test cells, temperature sensors, test cables, power cord, USB cable, communication software, user manual.

The METER is supplied complete with VACUUM PUMP + DESSICATOR and accessories to saturate the specimen with water (required by ASTM C1202).

#### Specifications:

Type	Value
Applied voltage (ASTM C1202 test)	60 $\pm$ 0.1 V
Range of current measurement	0 - 500 mA $\pm$ 0.1, $\pm$ 0.2%
Temperature measurement range	0 - 100 +/- 1°C
Operating temperature	15°C - 45°C
Operating humidity	30% - 80%
Measurement channel	4
Short circuit protection system	Yes
Measurement display on LCD	Yes
Remaining time display on LCD	Yes
LCD display area	65 x 33 mm
Operating voltage:	100-240V 50-60Hz 1ph
Dimensions of device	280x240x104 mm
Weight	2 kg

**C373-10N****CROSS HOLE ULTRASONIC SYSTEM - TWO CHANNELS, FOR DEEP FOUNDATIONS**

STANDARD: ASTM D6760-02

The Cross-hole Sonic Logging (CSL) method is used to perform high-resolution quality control on deep foundations.

The system uses an ultrasonic wave sent from an emitter to a receiver while both are pulled through water-filled access tubes embedded in the concrete. The measured arrival time and energy are directly related to concrete quality.

The control unit must be connected via USB standard to a regular notebook computer or Tablet PC (not included) on which, should be installed the software (included) for testing, analysis and real time reporting in 2 D Tomography.

Easy to use: the user-friendly software makes it possible to master the instrument in less than a day. No additional expensive training required. Powerful tomography features are available.

**SPECIFICATIONS**

- Housing: rugged, environment-proof, water-resistant housing.
- Temperature range: -25 to 60 °C (operating), -40 to 70 °C (storage).
- Transducers: dual-purpose transceivers, 50 kHz nominal, pressure-tested housing, Ø 25 mm
- Cables: detachable heavy-duty polyurethane wound on reel.
- Cable length: 50 m (100 m and 150 m cables are available upon request).
- Sampling rate: 500 kHz (2 µs resolution).
- Gain: 8 level automatic gain control (AGC).
- Depth meters: two 24-bit counters, <0.1% error.
- Pile measuring range: 1 to 145 m
- Tube spacing: up to 4 m in good concrete.
- Productivity: up to 3000 m/Day by a single operator.
- Memory storage: unlimited.
- PC minimum requirements: Windows 2000/XP, 300 MHz, 128 Mb, 800x600 resolution (not included).
- Reporting: arrival time, energy and wave speed curves, **waterfall** presentation, dual presentation, fuzzy-logic, tomography.
- The package includes: a computerized central unit, two ultrasonic transducers, two 50 m cable reels, two depth meter pulleys, cables and AC power adapter, and the software.
- Language: Multi-lingual user-interface and reporting.
- Power supply: internal rechargeable lithium ion battery (two days of typical use), external 100-240V AC (operation/charging).
- Dimensions: 430x325x105 mm (instrument only).
- Weight: 3.8 kg (instrument only).

**ACCESSORIES****C373-12** TWO 100 m CABLE REELS (instead of 50 m standard ones)**C373-13** TWO 150 m CABLE REELS (instead of 50 m standard ones)**C373-10N**

## REBOUND CONCRETE TEST HAMMERS

STANDARDS: EN 12504: Part 2 | ASTM C805 | DIN 1048  
 BS 1881:202 | NF P18-417

Designed to perform non-destructive tests on concrete structures, it gives an immediate indication of the compressive strength of the concrete using the calibration curve supplied with.

### MODELS

#### C380 CONCRETE TEST HAMMER MADE IN MATEST

Spring impact energy 0.225 mkg. (2.207 Joule or Nm)  
 Suitable for finished concrete structures and buildings having strength resistances from 10 to 70 N/sq.mm. **This concrete test hammer, entirely produced by Matest, has aluminium frame and thanks to its very accurate manufacture processing and selected components ensures high precision test results in the time. The top quality test hammer available on the market.**  
 Supplied complete with calibration curve chart in N/mm<sup>2</sup> (Mpa) values, abrasive stone, carrying case.

**Dimensions with the case:** 330x100x100 mm

**Weight:** 2 kg



C380



C380 with case

#### C380-01 CONCRETE TEST HAMMER MADE IN MATEST

Exactly the same as mod. C380, but with calibration curve chart in Psl values as requested by ASTM Specifications.

#### C381 CONCRETE TEST HAMMER MADE IN MATEST

Similar to mod. C380, but with impact energy of 0.735 Joule (Nm).  
 Ideal to test small sized, sensitive and thin walled materials.  
 Suitable to test also rock core samples.



C381

#### C390 ANVIL

STANDARD: EN 12504:2

Used for the verification of the calibration of the concrete test hammers. Special steel alloy made.

**Dimensions:** Ø 150 by 320 mm.

**Weight:** 16 kg approx.

#### Note:

The EN 12504:2 Specification requires obligatory the use of the anvil for the hammer tests.

The Standard specifies:

- Before a sequence of tests on a concrete surface, take and record readings using the steel reference anvil and check to ensure that they are within the range recommended by the manufacturer. If they are not, clean and/or adjust the hammer.
- After tests, take readings using the steel anvil, record them and compare them with those taken prior to the test. If the results differ, clean and/or adjust the hammer and repeat the test.



C380

C390

## ORIGINAL "SCHMIDT" TEST HAMMERS

#### C382

Standard model N for normal concrete casting.  
 Impact energy 2.207 Nm



C382

#### C383-10 SILVER SCHMIDT

Digital concrete test hammer. Impact energy: 2.207 Nm.



C383-10

**C386M****DIGITAL CONCRETE TEST HAMMER WITH MICROPROCESSOR MADE IN MATEST**

STANDARDS: EN 12504:Part 2 | ASTM C805 | BS 1881:202 | NF P18-417 | DIN 1048 | UNI 9189

This digital concrete test hammer, microprocessor operated, entirely designed and manufactured by Matest with advanced technology, performs basic concrete testing with continuous automatic recording of all parameters in accordance with EN 12504-2 Specifications, register and process data and then transfer them to a PC

The unit consists of the standard mechanical model C380, but equipped with an electronic transducer that measures the rebound values and supplies automatically the results on a graphic display.

**During test performing:**

- Shows index value
- Shows average index value
- Allows to select measuring system in N/mm<sup>2</sup> (MPa) or Psi
- Shows numbers of performed rebounds
- Shows date and time
- Identifies tested element
- Identifies automatically and shows rebound angle
- Shows battery life

**MAIN FEATURES**

- Possibility to store, display on graphic LCD 128x64 and download data to PC over 15000 tests
- Automatic statistical processing and readings
- Automatic conversion of rebound index to equivalent compression strength in psi, N/mm<sup>2</sup>, kg/cm<sup>2</sup>
- High accuracy and resolution

**C386M** with case**C386M****TECHNICAL SPECIFICATIONS**

- Impact energy: 2.207 Joule (Nm)
- Measuring range: 10 - 120 N/mm<sup>2</sup> (MPa)
- Interface: USB
- Power source: 6 rechargeable batteries AA NiMh 2400mA/hour
- Battery life: 60 hours with automatic shut down
- Operating temperature: -10°C +60°C

Supplied complete with data transfer software, data transfer USB cable, battery charger, abrasive stone, carrying case.

**Dimensions with case:** 330x180x120 mm

**Weight:** 3 kg

The digital Matest test hammer is suitable to be connected to the Ultrasonic Tester high performance mod. C372M (see p. 372) for combined ultrasonic and rebound tests with automatic data acquisition, processing and store of the results.

**C386M + C372M**

**Note:** The calibration anvil is the same (mod. C390) of the standard hammers.

**C393**
**RESONANCE FREQUENCY METER - DETERMINATION OF THE CONCRETE RESONANT FREQUENCY**

STANDARDS: ASTM C215, C666 | BS 1881:209 | NF P18-414 | UNI 9771

The unit measures the resonant frequencies of the three different modes of vibration:

- Longitudinal, transverse (flexural) and torsional.

From these, the following material characteristics, non destructively, can be calculated:

- young's modulus of elasticity,
- modulus of rigidity,
- poisson's ratio.

Available for specimen sizes up to 150 mm cross section dimension, and from 45 mm to 700 mm in length.

Automatic identification of the resonance frequency. Large easy to view display for data analysis of time domain and frequency spectrum signals.

Data can be stored and uploaded to a PC for further analysis and inclusion in report.

Fast and easy to use system.

The principle used in this meter is based upon the determination of the fundamental resonant frequency of vibration of a specimen generated by an impact and sensed by an accelerometer. The frequency spectrum is computed and displayed by the meter.

**Durability of concrete:**

The determination of flexural resonance is very important when studying the degradation of concrete under accelerated freezing and thawing cycles and aggressive environments on concrete specimens.

The advantages of resonance methods are:

- Test can be repeated over a very long period on the same specimen; the number of test specimens required is therefore greatly reduced.
- The results obtained with the resonance method on the same specimen are more reproducible than those obtained with non destructive tests and groups of specimens.

**Specifications:**

- Frequency range: 10 Hz to 20 kHz
- Sampling rate: 20 kHz or 40 kHz
- Accelerometer sensitivity: 9.60 mV/g (0.979 mV/ms<sup>2</sup>)
- Battery 12V, 4-10 hours continuous use.
- Display: 320 by 240; backlit for daylight use.
- Storage: 200 plus readings.
- Software: Windows compatible 9x/me 32 MB Ram.
- Impactors: set of 6 hardened steel balls.

The standard supply includes:

- electronic main unit.
- standard bench with its accessories.
- accelerometer with cable.
- hardened steel balls set.

**Weight:** 30 kg approx.

**C393**

## C369N ULTRASONIC PULSE VELOCITY TESTER HIGH TECHNOLOGY

STANDARDS: EN 12504 part. 4 | ASTM C597 | BS 1881:203 | NF P18-418

The instrument gives data concerning the homogeneity of the concrete, by generating pulses of sound into the concrete and measuring the time the sound to travel from the transmitter probe to the receiver probe through the material. Furthermore it is possible to have indicative data of the strength of the concrete.

### MAIN FEATURES

- Non-destructive test to determine cracks, voids, faults presence in concrete structures.
- LCD display 128x60 pixel.
- Battery operated rechargeable.
- Portable with anti-shock case.
- Supplied complete with calibrating cylinder and contact paste.

- Measuring range: 0 - 3000  $\mu$ s - accuracy  $\pm$  0.1  $\mu$ s
- Selection of the ultrasonic pulse amplitude adjustable from 250 to 1000 V
- Measurement of the required time by the ultrasonic pulse to go through the tested material.
- Single or continuous acquisition mode with automatic or manual saving.
- Zero calibration with depuration of the time for the pulse to go through the probes.
- Calibration of a defined time value.
- Capacity of data acquisition, processing and filing of the test data up to 30.000 samples.
- Interface mini USB for PC connection.
- Two outlets for connection to the oscilloscope.
- Languages: English, French, German, Spanish, Italian.
- The use of the instrument is made easy because it is based on the user-friendly system.

The standard appliance includes:

- The instrument in basic configuration in a practical palmer container.
- Two 55kHz probes with connection cables.
- **Battery rechargeable pack** NiMh 4.8V > 2000m/A with low battery condition alarm.
- External feeder 230V and battery charger 12V 500m/A.

**Case dimensions:** 400x340x110mm

**Weight:** 2 kg approx.

### ACCESSORIES

- C370-08** EXPONENTIAL TRANSMITTING/RECEIVING PROBES (couple), 55 kHz Nominal Frequency.
- C372-10** TRANSMITTING/RECEIVING PROBES (couple), 150 kHz Nominal Frequency, indicated for homogeneous, compact, high density concrete.
- C372-11** TRANSMITTING/RECEIVING PROBES (couple), 24 kHz Nominal Frequency, indicated for heterogeneous, low density concrete.
- C370-10** COUPLE OF CABLES (each 10 m long) to connect the probes to the tester. Used to test voluminous/large structures.



C369N



C369N with case

### SPARES

- C370-02** Transmitting/receiving probes (couple), 55 kHz
- C370-06** Couple of cables (each 3.5 m long) to connect the probes to the tester.
- C370-07** Tube of grease to better coupling the probes to the material under test.

**C372M**
**ULTRASONIC PULSE VELOCITY TESTER, HIGH PERFORMANCE**

WITH MICROPROCESSOR FOR COMBINED ULTRASONIC AND REBOUND HAMMER DATA ACQUISITION AND PROCESSING

STANDARDS: EN 12504: part 4 | BS 1881:203 | ASTM C597 | NF P18-418

**MAIN FEATURES**

- Touch screen LCD display 800x480 pixel.
- Windows operating system like a standard PC.
- Flash memory 128Mb, expandable with SD card to illimited memory.
- Time measuring from 0 to 9999,9  $\mu$ S resolution.
- Possibility to combine the ultrasonic measurement with rebound index (SonRed method).

This is an instrument using the most modern technologies; it has a 7" WVGA colour touch screen, 128 MB, SD card, USB, working system Windows CE.

**Ultrasonic tests:**

The appliance allows measuring the ultrasonic impulse **speed** inside the material (by knowing the distance between the probes). It measures the **distance between the probes** (by knowing the speed of the ultrasonic impulse to go through the tested material). It measures the required **time** by the ultrasonic impulse to go through the tested material.

**Young's modulus** for soils is also measured (by knowing the distance between the probes, the density of the tested material and the shear-speed).

Young's modulus for concrete is measured by knowing the distance between the probes, the density of the tested material and the poisson ratio.

Calculation of the **crack depth**.

Zero calibration with deperation of the time for the impulse to go through the probes.

Calibration of a defined time value.

Infinite filing capacity of the test dates and the graph tracing of the tests on SD card or extractable and expandable.  
 Possibility to use the instrument with two exponential probes, or with one standard probe and one exponential probe.  
 Possibility to connect the instrument to internet for consultations or extractions, like a common PC.  
 Visualization of the shape of the transmitting wave while it goes through the material checked, by transforming the instrument into a real oscilloscope.

**Combined ultrasonic and rebound hammer determination (sonreb method):**

The C372M ultrasonic tester houses an integral data logger for data acquisition, processing and store of rebound hammer values. The acquisition of the rebound values is performed with manual or automatic mode.

**a) Manual mode:**

Rebound values measured with a standard concrete hammer are manually input into the ultrasonic Tester.

**b) Automatic mode:**

The digital Matest test hammer mod C386N is directly connected to the ultrasonic tester through a cable. The measured rebound values are automatically transmitted to the C372M tester.

The measures of the velocity of ultrasonic pulses and the rebound values, gives estimates of dynamic modulus of elasticity and Poisson's Ratio, and provides informations on possible voids, cracks and strength of the structure.

It is possible to evaluate the compressive strength of the concrete, useful to estimate formwork striking times.

The combined test allow to rectify different inaccuracies that are typical of the simple rebound hammer test, and obtaining estimates on the compressive strength of the concrete, that cannot be obtained with the ultrasonic test, granting high accuracy and reliability of the results.

**C372M**

The standard appliance includes:

- Instrument in basic configuration (ARM Cortex-AS 400MHz, 128 MB Flash Memory, 128 MB Ram) in a practical and elegant palmer container.
- Two 55 kHz probes with connecting cables.
- Calibrating cylinder and contact paste
- Strong anti shock case holding the instrument and the accessories.
- Battery pack Li-Ion 11.1V 3000mA.h
- External feeder 230V/24V and battery charger

**Dimensions:** 400x300x180 mm

**Weight:** 3 kg approx.



C372M + C386N



C372M with case



Display of graphic function

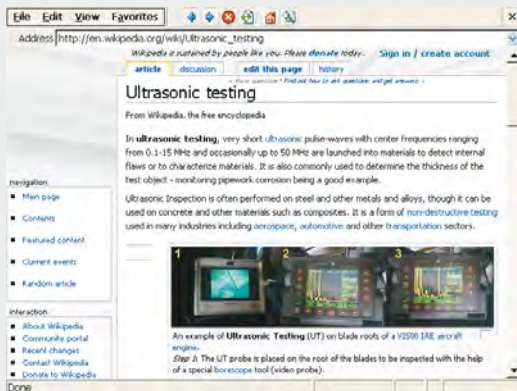

Display of internet function



Electronic card: detail

## ACCESSORIES

- C370-08** EXPONENTIAL TRANSMITTING/RECEIVING PROBES (couple), **55 kHz** Nominal Frequency.
- C372-10** TRANSMITTING/RECEIVING PROBES (couple), **150 kHz** Nominal Frequency, indicated for homogeneous, compact, high density concrete.
- C372-11** TRANSMITTING/RECEIVING PROBES (couple), **24 kHz** Nominal Frequency, indicated for heterogeneous, low density concrete.
- C370-09M** COUPLE OF CABLES (each 10 m long) to connect the probes to the tester. Used to test voluminous/large structures.



C372-10

## SPARES

- C370-02** Transmitting/receiving probes (couple), 55 kHz
- C370-04M** Couple of cables (each 3.5 m long) to connect the probes to the tester.
- C370-07** Tube of grease to better coupling the probes to the material under test.



C370-02

C370-08



## COVER TO REINFORCEMENT

For determining the presence, position, direction, depth and diameter of steel reinforcement bars in concrete structures.

STANDARDS: BS 1881:204 | DIN 1045

### C403-01 PROFOSCOPE

Versatile, fully-integrated rebar detector and cover meter with a unique real-time rebar display allowing the user to actually **SEE** the location of the rebar beneath the concrete surface to a maximum deep of 180 mm.

This is coupled with rebar-proximity indicators and optical and acoustical locating aids. Rebar diameter can also be estimated within the specified testing range.

The Profoscope combines these unique features in a compact, light device that allows the user to operate this rebar detector with one hand making the task of locating rebars a simple and efficient process.

An intuitive user interface makes rebar detection easy.

#### MAIN FEATURES

- Visual indication of rebars in close proximity.
- Ability to identify the mid-point between rebars as well as the orientation of rebars.
- Optical and acoustical indication of rebar location and minimum cover alert.
- Neighboring bar correction.
- Cordless and single handed operation.
- Icon-based language independent menus.
- Start-up test kit allows user to familiarize with all functions in a comfortable environment, wasting no time on site.



### C403-02 PROFOSCOPE+ (PLUS)

Same features of mod. C403-01, but additionally offers the innovative memory function for automatic data acquisition, by eliminating the manual measurements of a test series, saving time and unnecessary source of errors.



### C396N PROFOMETER PM-600

This new generation Profometer Touchscreen unit offers real time control over the measurement procedure for the precise and non-destructive detection of rebar locations and measurement of the concrete cover and rebar diameters directly on site.

The instrument comes along with the Universal Probe with integrated spot probe for measurements in corners, limited spaces and congested rebar arrangements.

Deep measuring range: up to 175 mm

Measurement accuracy: from  $\pm 1$  to  $\pm 4$  mm

Screen: 7" color, 800x480 pixel.

Diameter accuracy measurement:  $\pm 1$  mm

Diameter measuring range: up to 63 mm

**Weight:** 1600 g

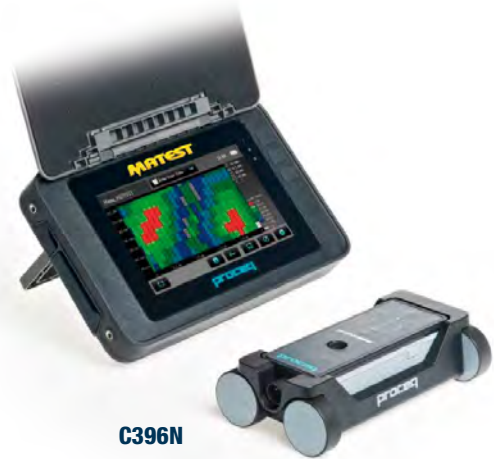

**Note:** Possibility to upgrade the Profometer C396N to Profometer Corrosion C411N for both corrosion and cover meter functions with the KIT below:

### C411-01N UPGRADE KIT TO PROFOMETER CORROSION C411N

Interface box, rod electrode, cable coil l=25 m with clamp, DVD with software, documentation and carrying case.

Technical details: see C411N.



## C411N PROFOMETER CORROSION

STANDARDS: ASTM C876, RILEM TC 154-EMC, DGZFP B3, SIA 2006, UNI 10174, JGJ/T 152, JSCE E 601

This instrument is the direct successor to the Canin and it is the most advanced corrosion detection device in the market. Consists in a non-destructive method to determine the corrosion of the reinforcement bars.

Same as C396N model, but with the accessories to detect corrosion and without the accessories to measure concrete cover and rebar location.

Supplied complete with rod electrode.

Memory:	internal 8 GB flash memory
Regional settings:	metric and imperial units and multi-language and timezone supported
Power input:	12 V $\pm$ 25 % / 1.5 A
Battery:	3.6 V, 14 Ah
Battery lifetime:	> 8h (in standard operating mode)
Humidity:	< 95 % RH, non condensing
Operating temperature:	-10 °C to +50 °C
IP classification:	touchscreen IP54, universal probe IP67
Voltage measuring range:	-1000 to + 1000 mV
Voltage resolution:	1 mV
Impedance:	100 M $\Omega$
Sampling rate:	900 Hz
Dimensions:	250x162x62 mm
Weight:	1600 g approx



**C411N**

**Note:** Possibility to upgrade the Profometer Corrosion C411N to Profometer PM-600 C396N for both corrosion and cover meter functions with the KIT below.

## C396-01N UPGRADE KIT TO PROFOMETER CORROSION

Universal probe with ruggedized cart, probe cable 1.5 m, software upgrade to cover meter.

Technical details: see C396N.



**C396-01N**

## C412-01 DIGITAL RESISTIVITY 2-PROBE ARRAY METER

Used for assessing the probable rate of corrosion in reinforcing bars with the electric resistivity measurement method.

A highly permeable concrete has a high conductivity with reduced electrical resistance. The knowledge of the electrical resistance of a concrete allows to measure the possible rate of corrosion of steel reinforced bars.

The test is simple to perform and requires only two 6.5 mm diameter holes drilled to a depth of 8 mm. Inject a small amount of conductive gel into each hole and insert the probes. The resistivity value is immediately displayed.

- Measuring range: 0.5 to 20 k $\Omega$  cm, with 0.1 k $\Omega$  resolution.
- 2-probe array spacing: 5 cm
- Display: LCD 4 ¼ digit
- Battery operated with 100 hours operating time

The instrument is supplied complete with drill bit, gel, template, accessories, carrying case.

**Dimensions:** 400x270x130 mm

**Total weight:** 4 kg



**C412-01**

## C414 COR MAP-HALF CELL METHOD

STANDARDS: ASTM C876 | BS 1881:201 | UNI 9535

A simple method for identifying areas of probable rebar corrosion in concrete structures.

Detachable electrode extension pieces (41 cm long), facilitate measurements in hard to reach locations.

High impedance digital meter is designed for tough field conditions. Reference electrode, including copper sulphate reservoir.

Easy to use, supplied complete.



**C414 complete set**

## C410 WINDSOR HP PROBE DIGITAL SYSTEM

STANDARDS: ASTM C803 | BS 1881:207 | ACI 347

To evaluate the compressive strength of concrete in place with the penetration method. Non destructive test. It is fast, accurate and simple to perform. The five-minute test does not weaken the structure. Comparison between test results using this method and destructive tests shows a variance normally within 3% from each other. The method requires a pistol-like device which is loaded with a small explosive charge and metal probe. The charge is precisely measured to give a consistent firing force. By pulling the trigger the probe is fired into the concrete.



**C410**

Standard equipment consist of:

- driven unit
- digital measuring unit with memory for data storage to PC unloading
- accessories and carrying case.

Probes and power charges **are not included** and must be ordered separately.

### Dimensions:

500x400x200 mm

**Weight:** 16 kg approx.



**C410 with case and accessories**

## ACCESSORIES

**C410-01** SILVER PROBES used for high performance concrete with strength up to 17000 PSI (110 MPa). Complete with probes and power loads. Pack of 75 probe Kit.

**C410-02** GOLDEN PROBES recommended for light weight concrete. Complete with probes and power loads. Pack of 75 probe kit.

## C410-10N PENETRATION PIN RESISTANCE DETECTOR

### PENETRATION RESISTANCE

STANDARD: ASTM C803

This portable instrument is used to measure the resistance of materials in situ for new or existing constructions. The operating principle which the instrument is based is the capacity to nail a pin into the surface of the material, since the penetration depth is inversely proportional to compressive strength is easy to determine the material resistance. The unit measures compression strength of concrete and mortar in situ with accuracy and speed. It is a safe tool that uses a mechanism equipped with a calibrated spring to insert a steel nail into the material to be investigated. The depth of penetration of the nail is measured and correlated with specific curves to the compression strength of the test material. The removable small section nail facilitates the use of the instrument and the correct execution of the test.

Penetration resistance:  $800 \pm 8$  N

Shot power:  $20 \pm 1$  mm

Digital measuring gauge:  $20 \pm 0.01$  mm

Nail dimensions: 3.5 mm diameter, 40 mm long

Supplied complete with 20 penetration nails, a little pump, a tightening key, a load lever, a carrying case.

**Dimensions:** 420x310x150 mm

**Weight:** 8 kg approx.

## SPARE

**C410-11** Penetration nails (pack of 20pcs).



**C410-10N**

## C403-10 DEEP SCANNING METAL DETECTOR UP TO 150 MM

This locator finds and scans, through solid concrete, steel rebars and metallic materials like pipes, electric cables, junction boxes, metal studs and frames up to 150mm deep.

It scans and differentiates steel rebars from other metallic materials like copper pipes.

It differentiates magnetic metals from non magnetic ones.

This detector is an essential device for building contractors, remodelers, electricians, plumbers.

Accuracy: rebars or pipes 14mm dia. with minimum grid space of 152mm are scanned within 13mm tolerance.

Depth:  $152 \pm 25$ mm

N° 1 alkaline battery 9V (not included) for one year use.

**Dimensions:** 250x110x62 mm

**Weight:** 300 g approx.



**C403-10**



C405-10N

C405-15M

### C405-10N DEFLECTOMETER WITH TELESCOPIC TUBULAR DISPLACEMENT TRANSDUCER

Used to determine the deflection under known loads of bridges, ceilings or any suspended structure.

This instrument grants very accurate and reliable test results with data acquisition through Cyber-Plus 8 Evolution mod. C405-15M. One telescopic deflectometer consists of:

- Aluminium telescopic tubular anodized frame having 1700 mm minimum height and 6000 mm maximum extension.
- Linear potentiometric displacement transducer with spring system, fixed on the base of the telescopic tubular frame, with measurements in compression 50 mm stroke and 0.01 mm resolution.
- Tripod supporting the telescopic tubular displacement transducer.
- 10 m extension cable.
- Carrying case.

**Weight:** 6 kg approx.

**Note:** Three deflectometers are recommended to correctly perform a test.

### C405-15M CYBER-PLUS 8 PROGRESS



**8 Channels** acquisition and processing data system, 24 bit resolution.

Electronic advanced technology, **display** LCD, TFT, 800x480 pixels, 7", **touch screen**, high graphic performances, the unit automatically performs test and data processing. A certificate can be printed through an external USB printer (optional).

The Cyber-Plus is equipped with LAN port for connection to PC and with USB port for an unlimited memory storage.

Contained in a practical and sturdy watertight carrying case, can be powered from an electrical network 90-270 V or use the internal battery and charger granting one full day on-site use.

Hardware technical details: see p. 18

**S337-51** CALIBRATION process of one deflectometer with the data acquisition unit C405-15M.



Example of use

### CISTERNS FOR LOAD TESTS

Made with flexible polystyrene covered in PVC, they are used to load the structure so to measure its deflection.

Supplied with connector, flexible pipe and spherical valve.

Available in different capacities:

Model	Capacity litres	Dimensions cm	Weight kg
C405-24	1000	240 x 145	10
C405-25	2500	280 x 240	16
C405-26	5000	400 x 240	25
C405-27	10000	490 x 340	40



C405-24

### C405-30 LITRE-COUNTER, ELECTRONIC, FOR CISTERNS

It measures and displays the quantity of water.

Accuracy:  $\pm 1\%$

Feeding. AAA standard batteries

**Weight:** 2 kg



C405-30

### SPARE

**C405-20** Chain, 10 m long, stainless steel, for measurements over 13 m.

## DEFLECTOMETERS - SWING-ARM MODEL

Used to determine the deflection on bridges, ceilings or any suspended structure. Possibility to use the deflectometer in pressure or traction, and direct reading on the dial gauge.

Available in **one** or **three** sets, to be completed with dial gauges stroke from 10 to 50 mm.

One deflectometer set comprises:

Swing-arm with clamp for complete orientation in any position, inextensible wire coil 20 metres long, plumb weight, carrying case. Supplied **without** dial gauge to be ordered separately (see accessories).

### MODELS

- C405N** N° 1 SET OF DEFLECTOMETER (without dial gauge)  
**C406N** N° 3 SETS OF DEFLECTOMETERS (without dial gauges)

### ACCESSORIES

- S376** DIAL GAUGE 10 mm stroke x 0.01 mm sens.  
**S377** DIAL GAUGE 25 mm stroke x 0.01 mm sens.  
**S378** DIAL GAUGE 30 mm stroke x 0.01 mm sens.  
**S379** DIAL GAUGE 50 mm stroke x 0.01 mm sens.  
**S383** DIGITAL GAUGE 25.4 mm x 0.001 mm sens.

### ACCESSORY for S383

- S382-13** CABLE to connect S382-01 and S383 to PC through USB port for direct visualization and recording of the measurement.

### SPARE

- C407-02** Inextensible wire coil, 20 metres long

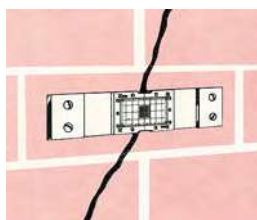

**C408**

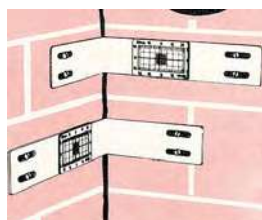

**C408-01**

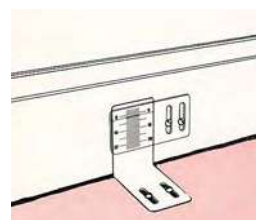

**C408-02**

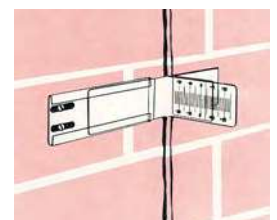

**C408-03**

## CRACK WIDTH GAUGES

Used for monitoring, measuring and recording the crack width of a building structure.

Internal or external use, manufactured in vandal resistant polycarbonate, complete with crack record card each gauge to simplify monitoring, they are suitable for vertical and horizontal movement measurements.

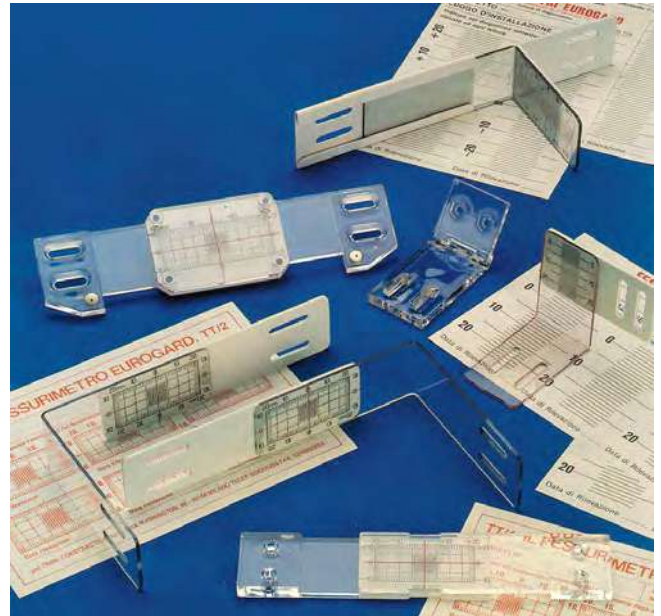

**C408...C408-03**

### MODELS

- C408** CRACK WIDTH GAUGE FOR WALLS, to monitor vertical and horizontal movements, also simultaneous, on a plane surface. Pack of 5 pieces.
- C408-01** CRACK WIDTH GAUGE FOR CORNERS, to monitor corner cracks with bidirectional movements, also simultaneous. Pack of 5 pieces.
- C408-02** CRACK WIDTH GAUGE FOR FLOORS, to monitor floor settlements to a wall, column etc. Pack of 5 pieces.
- C408-03** CRACK WIDTH GAUGE FOR DIFFERENCE IN LEVELS, to monitor the loss of levelness of any cracked surface. Pack of 5 pieces.

**C430****AUTOMATIC CONCRETE WATER PERMEABILITY APPARATUS AT FOUR CELLS**

This fully automatic apparatus is designed to perform water permeability tests on cubic concrete specimens max 150 mm side and cylinder specimens max 160 mm diameter. The specimens are submitted to hydrostatic stress for a pre-set period. The water permeated through the test specimen is directly collected and measured into a graduated cylinder.

It is therefore possible to determine the permeability coefficient in cm/sec. (Darcy coefficient) by the following formula:

$$K = \frac{c \times h}{A \times t \times P}$$

where:  $c$  = permeated water in  $\text{cm}^3$   
 $h$  = height of the specimen (cm)  
 $A$  = surface area of the specimen (sq. cm.)  
 $t$  = time to permeate (sec.)  
 $P$  = hydrostatic pressure in cm. of water column

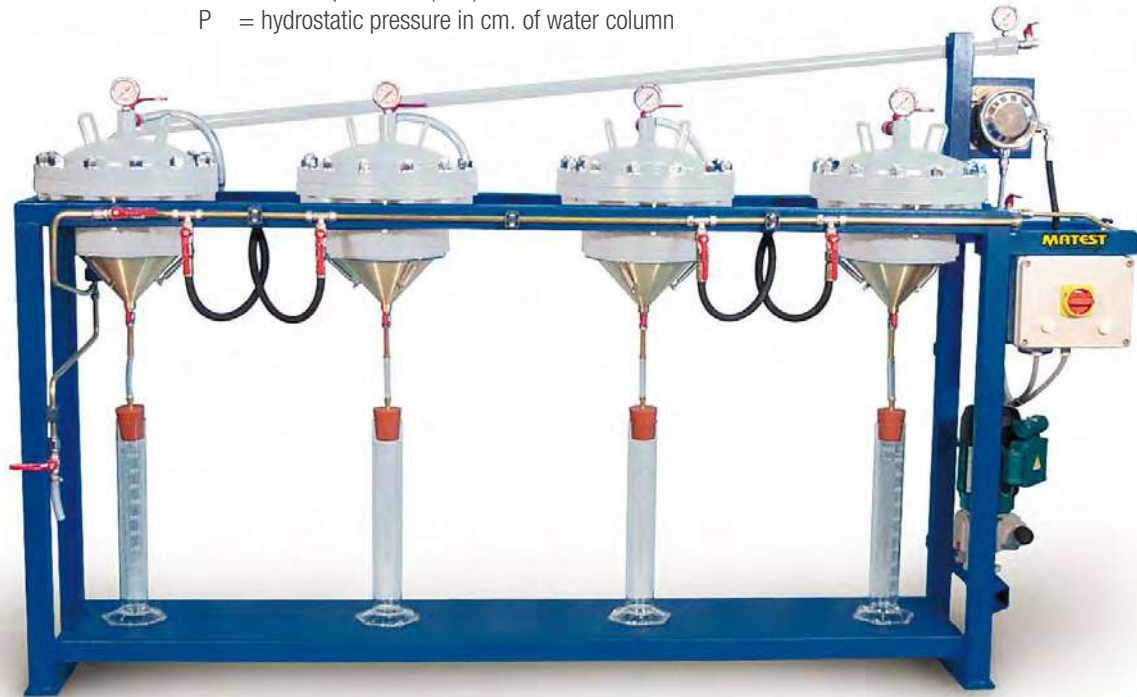
**C430**

The equipment consists of a strong metallic frame holding four cells which are hot-galvanized for anti-corrosion protection.

Each cell includes a pressure control manometer.

A re-chargeable compensation plenum chamber is included as part of the test.

The pressure is adjustable from 0 to 30 bar and it is supplied by an automatic pump of variable supply, to achieve the most suitable installation for the specimen under test.

Water feed is direct from water inlet.

Seal pressure obtained through special and practical seal devices which maintain and simplify the use of the machine.

It is possible to use one or more cells together, and specimens also of different size (cubes/cylinders).

The specimen's sealing system is achieved through a practical and speedy, user-friendly device.

Supplied complete with four cells, four graduated cylinders, epoxy resin and accessories. The **sealing devices are not included** in the standard package and must be ordered separately.

**Power supply:** 230V 1ph 50Hz

**Dimensions:** 2500x500x1300 mm

**Weight:** 240 kg approx.

**NEEDED ACCESSORIES**

SEALING DEVICE, complete with rubber latex packing which is between the two hot-galvanized steel collars. Complete with bolts.

**MODELS**

**C432-01** SEALING DEVICE FOR CUBES 100 mm side

**C432-02** SEALING DEVICE FOR CUBES 150 mm side

**C432-04** SEALING DEVICE FOR CYLINDERS Ø 100 mm

**C432-05** SEALING DEVICE FOR CYLINDERS Ø 150 mm

**C432-06** SEALING DEVICE FOR CYLINDERS Ø 160 mm

**C432-02****C432-05****SPARE**

**C433** Epoxy resin, to isolate the lateral surfaces of the concrete specimen. Can of 5 kg

## WATER IMPERMEABILITY TESTER

DETERMINATION OF PENETRATION'S DEPTH OF WATER UNDER PRESSURE.

STANDARDS: EN 12390-8 | DIN 1048

This apparatus is used to determine the depth of penetration of the water into the concrete

(impermeability) under known time and pressure.

The unit accepts concrete cubic, cylindrical or prismatic specimens having **max. dimensions** of 200x200x200 mm.

The specimen is put into the test chamber, clamped with **suitable flanges with central screw** and round gaskets.

A known water pressure is applied on the specimen's surface for a known time, as requested by Standard, using a suitable air compressor (see accessory) having at least 5 bar pressure.

A manometer checks constantly the applied water pressure.

The apparatus is supplied **complete with graduated burettes** fixed on the front panel.

The water penetrated is measured by breaking the specimen, or by reading the water permeated through the graduated burette.

Two models available: three place and six place version. The places can be used all-together at the same time, or one by one independently.



**C435-01**



**C435**

### MODELS

#### C435

CONCRETE WATER IMPERMEABILITY APPARATUS, THREE PLACE, with water measurement burettes.

**Dimensions:** 1400x750x1700 mm

**Weight:** 280 kg approx.

#### C435SP

CONCRETE WATER IMPERMEABILITY APPARATUS, THREE PLACE, same as mod. C435, but having three separate pressure lines

#### C435-01

CONCRETE WATER IMPERMEABILITY APPARATUS, SIX PLACE, with water measurement burettes.

**Dimensions:** 1400x750x1850 mm

**Weight:** 430 kg approx.

#### C435-11

DUAL PRESSURE LINE to upgrade the apparatus mod. C435-01

### ACCESSORIES

**V206** AIR COMPRESSOR, 70 litres capacity.  
230V 50Hz 1ph.

**E138-11** TUBING and accessories to connect the impermeability apparatus to the air compressor.

OUR **CLIENTS** ARE OUR BEST  
ADVERTISEMENT.







**MATEST**

**SERVO  
PLUS  
EVOLUTION**

**CYBER  
PLUS  
EVOLUTION**

# SECTION E

## CEMENT - MORTAR



The raw materials like: limestone, chalk, shale, clay etc., mixed with water, are crushed, ground and blended. They are now submitted to a chemical process in a rotary kiln until they combine into clinker. From the clinker opportunely mixed with gypsum, the cement factories obtain the modern Portland cement, that may be modified in more and more sophisticated binders like expansive mortars, pre-mixed cements etc.

In section "Cement & Mortars" Matest proposes a complete range of equipment for:

Fineness, Consistency, Setting-time, Workability, Soundness, Flow, Fly Ash, Lime reactivity and Slaking, Chemical Tests etc.; and for Mixing, Moulding, Curing and Strength Tests, to satisfy all the above quality variables, in compliance with the EN, ASTM and the most known International Standards.



**E009 KIT**
**BLAINE AIR PERMEABILITY APPARATUS**

TO DETERMINE THE FINENESS OF CEMENT

STANDARDS: EN 196-6, comparable to:

ASTM C204 | AASHTO T153 | BS 4359:2

Used to determine the fineness of Portland cement in terms of the specific surface expressed as total surface area in square centimeters per gram of cement.

The apparatus is supplied with glass U-tube manometer with valve, steel stand, test cell with disk and plunger all in stainless steel, rubber aspirator bulb, 1000 filter paper disks, manometric liquid, vaseline grease for better coupling tube/cell, funnel, brush.

**Dimensions:** 220x180x470 mm

**Weight:** 12 kg approx.

**E009 KIT + E055-08**
**ACCESSORIES**
**E010-02** STANDARD REFERENCE CEMENT 114q. to calibrate the Blaine.

Alternative:

**E010-02N** STANDARD REFERENCE CEMENT SN2c. Portland (CEM I 52,2N) turbinometric and fineness. Bottle of 5 g

**E055-08** GLASS THERMOMETER -10 to +50 °C.

**SPARES**
**E010-01** U-tube glass manometer complete

**E010-03** Manometric liquid 250 ml bottle

**E010-04** Filter paper discs, porosity: 2 micron (pack of 1000 pieces)

**E010-08** Test cell, complete (three pieces)

**E010-05** Cell body, stainless steel

**E010-06** Cell plunger, stainless steel

**E010-07** Cell perforated disk, stainless steel

**E011**
**ELECTRONIC BLAINE AIR PERMEABILITY APPARATUS, SEMI-AUTOMATIC**

Electronic Blaine air permeability apparatus with semi-automatic test-cycle, electric suction pump, time registration and measuring section with photoelectric barrier. After the test, automatic display of the time measured. Precision of time displayed: 0.01 second. The apparatus is delivered complete with filter papers (1000 pcs.), oil, light grease, plug, thermometer, brush and funnel.

**Power supply:** 110-230V 50-60Hz

**Dimensions:** 170x300x410 mm

**Weight:** 4.6 kg

**E011**
**E011-01N**
**BLAINE AIR PERMEABILITY APPARATUS, PC-CONTROLLED**

This automatic electronic apparatus is designed for the fully automatic test procedure and evaluation, software automatically acquires all test data and performs average calculations. Complete with filter papers (1000 pcs.), oil, light grease, plug, internal sensor, brush and funnel. Provided with software but without PC (standard PC required).

**Power supply:** 110-230V 50-60Hz

**Dimensions:** 170x280x410 mm

**Weight:** 4.7 kg

**E011-01N**

## E014 LE CHATELIER FLASK

STANDARDS: EN 196-6 | ASTM C188  
AASHTO T133

Used to determine the relative density (specific gravity) of hydraulic cement and lime. Capacity 250 ml. The neck is graduated from 0 to 1 ml and from 18 to 24 ml with divisions of 0.1 ml.

**Weight:** 500 g



V192-08

### ACCESSORY

#### V192-08

CHATTAWAY SPATULA, 120 mm long.



E014

## E016 WATER FLOWING SIEVES DEVICE

STANDARD: D.M. 3/6/68

Used to determine the fineness of cement. It consists of a spraying unit with feed cock and gauge; brass sieve body 85 mm Ø and 95 mm high with two stainless steel cloth disks having opening 0.18 and 0.09 mm. A cement sample of 25 g is placed inside the sieve and washed for two minutes by means of the spraying unit put on top of the sieve. The residue of the retained cement is obtained by drying the sieve at 110 °C.

**Weight:** 3 kg



E016

## E017 FINENESS OF FLY ASH BY WET SIEVING

STANDARDS: EN 451-2 | ASTM D430

The set, brass made, consists of: sieve Ø 50 mm. with stainless steel mesh opening 0.045 mm, spray nozzle 17.5 mm ID with 17 holes Ø 0.5 mm, pressure gauge Ø 80 mm range 0-160 kPa, div. 5 kPa, fittings and connectors.

**Weight:** 3 kg



E017

## E029 MEASURER 400 ML CAPACITY

STANDARDS: ASTM C185 | AASHTO T137

To determine the air content of freshly mixed mortars by the density method.

Steel made, internal diameter 76.2x88.1 mm height.

### ACCESSORIES

#### E087-06

HARD WOOD TAMPER

#### E055-07

GLASS PLATE, nominally 120 mm diameter

#### V192-08

CHATTAWAY spatula



V192-08

E055-07

## E020 BULK CEMENT SAMPLER

STANDARDS: EN 196-7 | ASTM C183 | AASHTO T127

Used to sample cement in bulk storages or shipment.

Brass made, it consists of two concentric tubes with slots. Inside tube volume is 3 litres approx.

**Dimensions:** Ø 40x1500 mm. **Weight:** 5 kg

## E021 PACKAGED CEMENT TUBE SAMPLER

STANDARDS: EN 196-7 | ASTM C183 | AASHTO T127

Used to sample cement homogeneously from cement bags.

**Dimensions:** Ø 32x1050 mm. **Weight:** 3 kg

E020

E021

## E025 BULK DENSITY OF CEMENT

This apparatus is used for the measurement of the apparent density (bulk density) of powders and non-cohesive materials.

It consists of sieve funnel with tripod, unit weight measure 1 litre capacity, spatula, straight edge, aluminium scoop.

The discharge hole of the funnel has 8 mm diameter.

**Dimensions:** Ø 350x520 mm  
**Weight:** 6 kg approx.



E025

**E027**
**AIR CONTENT METER 1 LITRE CAPACITY**

STANDARD: EN 459-2 | EN 1015-7

Designed to determine the air content in cement mortar, cement paste and lime mortar. Made from cast aluminium, the test pot one litre capacity and the upper part are air-tight sealed by means of two quick action spring clamps. The whole is connected to a dial gauge directly indicating the air entrainment in percentage, with range 0 - 50%. A built-in operated air pump is also included. The push-buttons TEST and CORRECTION are arranged to perform the test in a simple and quick system.

**Dimensions:** Ø 200 by 320 mm

**Weight:** 3.5 kg

**E027-01**
**AIR CONTENT METER 0.75 LITRE CAPACITY**

STANDARD: EN 413-2

Identical to mod. E027, but with vessel having 0.75 litre capacity, conforming to EN 413-2 Specification.

**E028**
**AIR CONTENT METER 1 LITRE, ELECTRIC**

STANDARD: EN 459-2

Same as mod. E027, but with incorporated an electric mini-compressor giving air pressure and keeping it constant all along the test.

**Power supply:** 230V 1ph 50-60Hz

**E028-02**
**AIR CONTENT METER 0.75 LITRE, ELECTRIC**

STANDARD: EN 413-2

Identical to mod. E028, but with vessel having 0.75 litre capacity, conforming to EN 413-2 Specification.

**ACCESSORY**
**E028-01** FILLING HOPPER (Ring) for the meters E027, E027-01, E028, E028-02

**E027**
**E028**
**E034**
**LIME TESTING REACTIVITY APPARATUS**

STANDARDS: EN 459-2 | NF P98-102

This apparatus is used for determining the reactivity on slaking of ground quicklime.

The equipment consists of a Dewar vessel 1000 ml capacity complete with cover, electric stirrer 300 rpm. complete with stirring paddle (propeller), base with stand, digital thermometer range -50 +200 °C subd. 0.1 °C, accessories.

**Power Supply:** 230V 1ph 50-60Hz

**Dimensions:** 400 x 250 x 750 mm

**Weight:** 10 kg approx.

**ACCESSORY**
**E034-05**

WEIGHTING AND FILLING CONTAINER

**SPARES**
**E034-11**

Dewar vessel

**E034-12**

Stirring paddle (propeller)

**E034-12**
**E034-05**
**E034**
**E035**
**SLAKING VESSEL**
**YIELD OF LIME-BUILDING LIME**

STANDARD: EN 459-2

This insulated vessel is used to determine the yield of lime by leaving the lime sample to slake into.

Stainless steel made, double walled insulated with glass fibres, the cylinder has inside dimensions Ø 113 by 140 mm deep. Supplied complete with cover.

**Weight:** 4 kg approx.

**E035**

### E091 BULK DENSITY OF LIME

STANDARDS: EN 459-2 | DIN 1060

The apparatus allows a sample to fall from a known height into a volumetric container. Consisting of a hopper, one litre cylindrical container and spring loaded trap.

**Weight:** 5 kg approx.



E091

### E031 DROPPING BALL APPARATUS

STANDARDS: BS 4551-1, 6463-4

Used to measure the consistency of cement mortars, this instrument allows a mm 25 diameter acrylic ball to fall freely from a standard height of 250 mm into a specimen of mortar contained into a brass ring mould, and the surface of which has been carefully prepared. The depth of the ball penetration into the mortar gives the specimen consistency. The instrument comprises a dropping device mounted on a stand, acrylic ball, mould Ø 100x25 mm. The base of the stand is machined. Chromed finishing.

**Weight:** 8 kg approx.

#### ACCESSORY

##### E031-01

BALL PENETRATION MEASURING DEVICE, formed by a tripod on which a dial gauge 25x0.01 mm is mounted. A device to adjust the height of the dial in relation to the tripod is also included. Chromed finishing.

**Weight:** 1 kg approx.



E031

E031-01

### E039-01 CEMENT WATER RETENTION APPARATUS

STANDARDS: ASTM C91, C110

Used to determine the water retention value of cement and lime putty. The unit comprises: water aspirator, vacuum regulator, vacuum gauge three-way stopcock, metal perforated dish, glass funnel, pack of filter paper, accessories; the whole assembled on stand. The vacuum pump with accessories are not included in the supply and have to be ordered separately.

**Dimensions:** 400x300x600 mm

**Weight:** 8 kg approx.



E039-01

#### ACCESSORIES

##### V205 + V205-10 + V230-03

Vacuum pump with accessories. **Power supply:** 230V 1ph 50Hz  
See p. 597

### E036 KIT FLUIDITY TEST OF GROUTS FOR PRE-STRESSING TENDONS: GROUT SPREAD METHOD

STANDARD: EN 445 (2007)

The grout spread test measures the fluidity of thixotropic grouts. The fluidity is measured by the diameter of the circle of grout spread on a smooth plate after a fixed period.

**E036-01** STIFF PLASTIC MOULD with internal diameter of 39 mm and a height of 60 mm

**Weight:** 70 g approx.

**E036-02** GLASS PLATE, dimensions 305x305 mm



E036 KIT

## E038 FLOW CONE APPARATUS

STANDARDS: EN 445 / NF P18-358, P18-507

Used for viscosity and fluidity determinations of mortars, muds, grouts, pre-stressing tendons, fluid materials, etc. Cone top diameter is 155 mm, total length 290 mm, capacity 1700 cc. Mortar fluidity is considered suitable when the flow time of 1000 cc of mortar is comprised between 17 to 25 seconds. Entirely brass made, it is supplied complete with four interchangeable nozzles  $\varnothing$  8 - 9 - 10 - 11 mm, stand adjustable in height, plastic graduated cup.

**Weight:** 10 kg approx.

### ACCESSORIES

**E038-01**  
INTERCHANGEABLE NOZZLE  $\varnothing$  13 mm

**E038-02**  
SIEVE,  $\varnothing$  150 mm, 1.5 mm mesh opening that fits the upper cone.

## E037 MARSH FUNNEL MUD VISCOSIMETER

STANDARDS: ISO 2431

Utilized for viscosity determination on drilling muds and fluid materials. Orifice opening 4.7 mm. Half part of the funnel mouth is foreseen of sieving cloth 2 mm mesh. Plastic break-resistant made. Supplied complete with graduated cup.

**Weight:** 1 kg approx.



**E038-02**

**E038**

**E038-01**



**E037**

## E037-10 SAND CONTENT OF DRILLING MUDS KIT

The Sand Content Kit is a simple, accurate and inexpensive sieve analysis apparatus for determining the sand content of drilling muds. The kit consists of a special 200-mesh sieve 2.5" in diameter, fastened inside a collar upon which a small funnel is fitted on either end. This is used with a 10ml glass measuring tube, graduated to read from 0 to 20% the percentage sand by volume. The collar and funnel are made of polyethylene and the screen is made of brass. A 500 ml wash bottle and carrying case are included.

**Weight:** 1500 g

## E037-01 BAROID MUD DENSITY BALANCE

It provides a simple method for the accurate determination of mud density.

The balance consists of a base and graduated arm with cup, lid, knife edge, rider, built-in spirit level and counter-weight, carrying case. The constant volume cup is affixed to one end of the graduate arm and the counter-weight on the opposite end.

**Weight:** 3 kg approx.



**E037-01**

## E037-05 FILTER PRESS FOR MUDS

STANDARD: API (American Petroleum Institute), recommended practice 13B-1 and 2

This filter press is the most effective means for determining the filtration properties of drilling muds, fluids and cement slurries. The filter press consists of a mud reservoir mounted in a frame, a pressure source, a filtering medium, and a graduated cylinder for receiving the measuring filtrate, pack of 100 filter paper, CO<sup>2</sup> pressurized cartridges.

**Dimensions:**  
210x240x500 mm approx.  
**Weight:** 10 kg approx.



**E037-05**



**E037-10**

## E055N VICAT APPARATUS

### SETTING TIME AND CONSISTENCY OF CEMENT

STANDARDS: EN 196-3 | EN 480-2 | EN 13279-2 (gypsum)

ASTM C191 | AASHTO T131 | NF P15-414, P15-431

The instrument consists of a metallic frame, graduated scale with index, sliding probe of 300 g, consistency plunger  $\varnothing$  10 mm, glass base plate.

The needle and conical mould are not included and have to be ordered separately according to the selected Standard (see accessories).

**Dimensions:** 160x200x300 mm

**Weight:** 5 kg approx.



**E055N** with accessories

### NEEDED ACCESSORIES

- E046N** NEEDLE, hardened  $\varnothing$  1.13 mm EN 196-3  
**E046-01N** NEEDLE, hardened  $\varnothing$  1 mm ASTM - AASHTO  
**E055-10** CONICAL PLASTIC MOULD  $\varnothing$  70/80 h 40 mm (EN - NF)  
**E055-05** CONICAL PLASTIC MOULD  $\varnothing$  60/70 h 40 mm (ASTM - AASHTO)

CONICAL MOULDS TO BS, DIN, UNI SPECIFICATIONS:

- E055-04** CONICAL PLASTIC MOULD  $\varnothing$  80/90 h 40 mm (UNI)  
**E055-13** CONICAL PLASTIC MOULD  $\varnothing$  65/75 h 40 mm (DIN)  
**E055-11** CONICAL BRASS MOULD  $\varnothing$  80/90 h 40 mm (BS)

### ACCESSORIES

- E055-06** ADDITIONAL WEIGHT 700 g to the sliding probe (EN - NF)  
**E042N** FINAL NEEDLE  $\varnothing$  1.13 mm (EN - NF - BS)  
**E042-01N** FINAL NEEDLE  $\varnothing$  1 mm (Standards: ASTM - AASHTO)  
**E055-08** GLASS THERMOMETER -10 to +50 °C.  
**E044-40N** CONICAL PENETRATION NEEDLE  $\varnothing$  8 mm by 50 mm long for gypsum tests. Standards: EN 13279-2 | DIN 1168  
**E055-15** PROBE, total weight of 100 g for tests on gypsum, EN 13279-2 | DIN 1168



Accessories and Spare Parts for **E055N**

### SPARES

- E055-07** Glass base plate  $\varnothing$  120 mm  
**E044-48N** Tang to fix the needle to the probe  
**E042-02N** Consistency plunger  $\varnothing$  10x50 mm

## E058 GILLMORE APPARATUS

STANDARDS: ASTM C91, C141, C266, C1398 | AASHTO T154

Used to determine the setting time of cement. Vertical support shaft has a device to maintain the horizontal arms in alignment. Support assembly is adjustable in position. The two steel weights needles are calibrated to meet Specifications. Needle points are from stainless steel. The initial setting needle has a diameter of 2.12 mm and a weight of 113 g, while the final setting needle has a diameter of 1.06 mm and a weight of 453.6 g.

**Weight:** 3 kg approx.

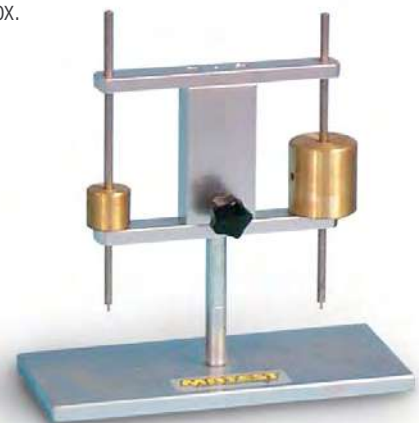

**E058**



**E044N**
**VICATRONIC - THE WORLD'S MOST POPULAR AUTOMATIC VICAT APPARATUS**
**AUTOMATIC COMPUTERISED TROPICALIZED VICAT RECORDING APPARATUS**

STANDARDS: EN 196-3 | EN 480-2 | EN 13279-2 (gypsum) | ASTM C187, C191 | DIN 1168, 1196 | NF P15-414, P15-431 | AASHTO T131

The Vicatronic apparatus, that is designed and manufactured using the most recent and sophisticated technology, is used for the initial and final setting time determination of cements or mortar pastes.

The unit is manufactured with **anticorrosion and tropicalised** components to be used in places with humidity not below 90% and 20°C. controlled temperature as required by EN Specifications.

The entire test is made in a fully automatic way and gives a very precise and repeatable result. The results are printed on the incorporated printer and this eliminates the manual operations of installing and zeroing the paper graph on the drum.

The use of the appliance is extremely simplified by the guiding menu that is available in english, french, spanish, german, polish, italian language.

The Vicatronic is supplied with the standard programs to make automatically, all the tests according to the following Standards:

EN 196-3 | EN 13279-2 gypsum | EN 480-2 | ASTM C191 | DIN 1164 | DIN 1168 gypsum | NF P15/431 | BS 4550 | AASHTO T131

**MAIN FEATURES**

- Large high contrast and high resolution LCD screen.
- Real time graphic display of the test.
- Fully automatic test performance.
- Customizable programs for research tests.
- Suitable to operate through the embedded control unit or a separate PC.

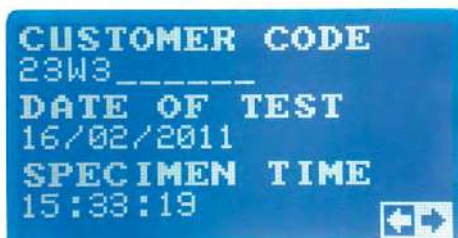
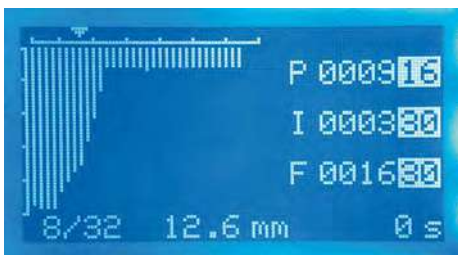
**E044N**

90 penetrations program

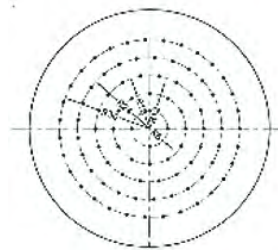

ASTM

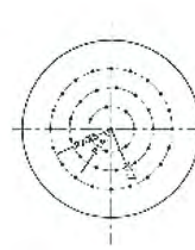

EN

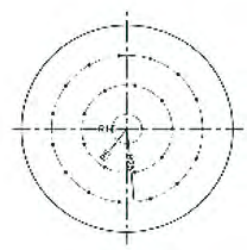

## PROBES

The mobile probe weighs 300 g (1000 g following the EN, NF Standards), the penetration needle has 1.13 mm diameter (1 mm following ASTM Standard) and its fall can be programmed in free fall or in guided fall. Totally flexible as far as the time is concerned, the penetrations time can be selected between 0.5 minutes and 999 minutes (fix interval between two penetrations of a test) or can change during the test up to 5 different phases with different interval time; it can even change automatically during the setting time fixing a penetration depth. The two options described here above can be combined together.

The penetration measure is read by a very accurate encoder having a resolution of 0.1 mm

The Vicatronic also calculates, visualises and prints:

- The time from the moment of the sample preparation (set by the operator).
- The time the test starts.
- The residual time to the next penetration.
- The residual time to the end of the test
- The number of penetrations made and the residual penetrations to be made.

## TIMER 0 – 999 MINUTES

The firmware allows activating a delay on the appliance to the beginning of the test. This program is particularly useful when the approximate setting time of the mortar is known and the operator wants to start the working of the Vicatronic after a certain time in order to concentrate the penetrations with a short interval of time between them and have better measuring values.

## TEST RESULTS

The Vicatronic can memorise all the test parameters and results and keeps a file with a capacity of more than 50 complete tests.

In case of a power cut, even a short one, during the test execution, the test will be invalidated and the appliance will be automatically stop keeping the set data.

At the end of the test the appliance will print automatically by the incorporated printer a report with all data concerning the last test made including a graph tracing each single penetration with its values of time and penetration number (see example printed).

TEST NUMBER :	0996	
KIND OF TEST :	BS4558	
POINTS MOVE [mm]		
17	0.00	
11	10.00	
5	10.00	
1	10.00	
OPERATOR CODE :	F	
CUSTOMER CODE :	23M3	
DATE OF TEST :	15/02/2011	
SPECIMEN TIME :	14:36:16	
START DELAY[mi] :	1	
1ST PEN TIME :		
SPECIMEN TYPE :	X5	
WATER CONT. [x%] :	89.0	
TEMPERATURE [°C] :	22.3	
HUMIDITY [x%] :	69.1	
FALL TYPE :	DRIVEN	
TIME TYPE :	FIXED	
FINAL SETTING :	NO	
TIME [m] :	1/2	
ID PEN. [mm]	P [n.s]	I [n.s]
1D PEN. [mm]		
1	0.0	
2	0.0	
3	0.0	
4	0.0	
5	0.0	
6	0.0	
7	0.1	
8	5.4	
9	6.6	
10	7.9	
11	9.3	
12	11.1	
13	12.6	
14	13.6	
15	14.9	
16	15.8	
17	16.5	
18	19.3	
19	20.3	
20	21.6	
21	23.1	
22	24.8	
23	26.7	
24	28.3	
25	29.6	
26	31.1	
27	35.8	
28	37.2	
29	39.0	
30	40.5	
31	42.6	
32	42.5	
33	42.9	
34	42.9	



Printing Example

```

1ST PENETR TIME
--:--:--
START DELAY [m]
1
SPECIMEN TYPE
X5

```

```

COMBINED
ID      TIME [m]
34 *    1
34      1
34      1

```

```

THRESHOLD
TIME 1 [m] : 1
THRES. [mm]: 48.0
TIME 2 [m] : 1

```

### PC CONNECTION AND NET OPTIONS

Despite the totally independent working of the machine that includes an incorporated printer, the Vicatronic has been designed for a PC connection (RS232) with the possibility to download the test data using a common program (Microsoft Hyper Terminal) that is normally incorporated with the Windows package of the PC. In this case the data processing will have to be made by the operator.

The **Vicat-Win** software (accessory mod. E044-11) allows receiving, managing, processing and completing the test dates; it will trace automatically the graph, personalise and print the test report.

The Vicatronic offers the possibility, buying the kit **Vicat-Net** (accessory mod. E044-12), to connect up to 20 appliances on a net managed by a PC through two pins RJ45 with RS485 protocol. This allows obtaining a complete remote control from the PC of each single Vicatronic.

The details of the performances are following:

- Transfer each single control or function of the Vicatronic on the PC
- Verify in real time each phase of the test being made.

- Automatically download the final results at the end of the test on all the connected Vicatronic.
  - Process and file at the same time all the tests without obliging the operator to move from his working place.
- Additionally the firmware has many other functions detailed in the technical chart that will be transmitted to the user interested to know more about it.

The Vicatronic is supplied complete with the incorporated printer, two hardened needles (one with 1 mm diameter and one with 1.13 mm diameter), two conical moulds EN and ASTM, a glass plate to hold the conical mould.

**Power supply:** 230V 1Ph 50-60Hz 50W

**Dimensions:** 400x200x470 mm

**Weight:** 13 kg approx.

### E044-03 N

VICATRONIC, identical to mod. E044 N, but with possibility of continuous penetrations each 15 seconds.

## ACCESSORIES

**E044-11** SOFTWARE **VICAT-WIN** complete with connection cable of 3 metres that allows by the RS232 port downloading, processing, printing and managing all the data directly from the PC.

**E044-12** **VICAT-NET KIT** to connect up to 20 Vicatronic on a net by means of two connectors RS485 managed by a PC. The kit includes: the software, the RS232/485 converter and the cable for the connection of **one appliance**. For net connection of additional Vicatronics (up to max. 20) see the below accessory mod. E044-13

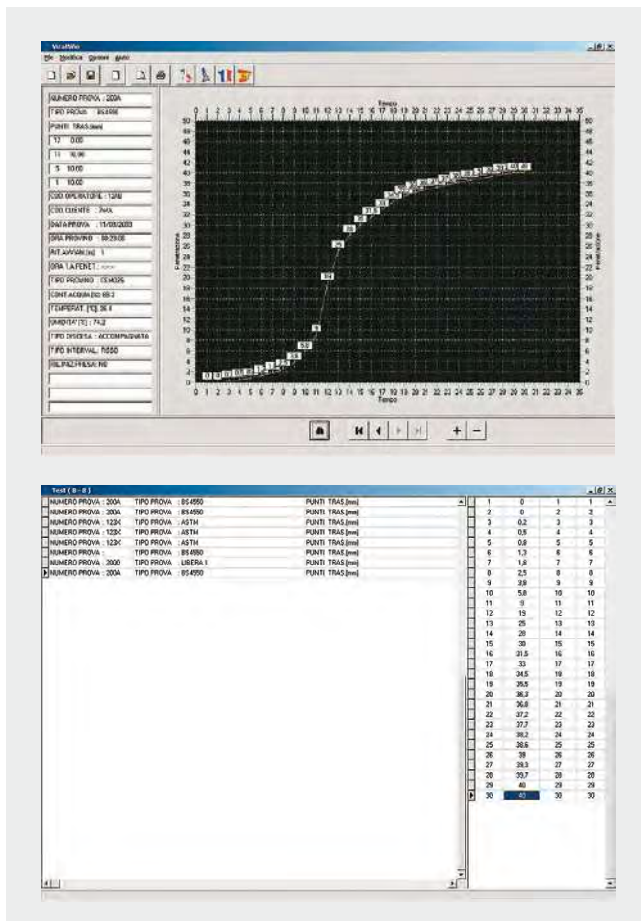

**E044-13** COMPLETE KIT with cable for serial connection RS485, 5 metres long for the connection of one Vicatronic to the PC or to a net (cables with different length are available on demand).

## E044-06 THERMOSTATIC CONTROLLED HEATING/COOLING SYSTEM "TWO" VICATRONIC



The device produces water with suitable heating and cooling elements at controlled temperature of  $20\text{ °C} \pm 0.5\text{ °C}$ . The water is forced into the tank E043 and then back to the bath allowing to perform the test at controlled temperature and humidity as requested by EN196-3 Standard. The system accepts ONE or TWO Vicatronic.



E044-06

### Specifications:

Water capacity: 7.5 litres approx.

Optimized temperature range:  $15\text{ to }25\text{ °C}$

Accuracy:  $\pm 0.5\text{ °C}$

**Power supply:** 230V 1ph 50-60Hz 350W

**Dimensions:** 415x300x420 mm approx.

**Weight:** 20 kg approx.

### ACCESSORY

**B059M-11** TEMPERATURE PROBE, PT100: Measurement of the water temperature in real time. It's connected with the monitor in order to show the temperature during each test, to collect the data at the end of penetration and to include the temperature data in the final reading.



E043

### E043

MOULD TANK to test the specimen immersed in water. The test must be performed in room having a controlled temperature of  $20\text{ °C} \pm 1\text{ °C}$ .

The saturated humidity is obtained by the immersion in water of the specimen as required by the standard EN196-3.

## GYPSUM TEST

STANDARDS: EN 13279-2 | DIN 1168

### E044-40 N

CONICAL PENETRATION NEEDLE, having 8 mm of diameter and 50 mm long, to make gypsum tests following EN, DIN Specifications.

### E044-41 N

PROBE 100 g, to make test on gypsum following EN, DIN Specifications.



E044-40N

### E044-30

NEEDLE CLEANING DEVICE

It removes the residual cement particles from the needle keeping it constantly lubricated.



E044-30



Accessories and Spare Parts for E044N

- E042-02N** CONSISTENCY PLUNGER  $\varnothing 10 \times 50\text{ mm}$
- E042N** NEEDLE for final setting  $\varnothing 1.13\text{ mm}$ , BS, EN 196-3
- E042-01N** NEEDLE for final setting ASTM 1 mm diameter.
- E044-45** ADDITIONAL 700 g WEIGHT (EN, NF)
- E055-04** PLASTIC MOULD  $\varnothing 80/90 \times 40\text{ mm}$  high following UNI
- E055-11** BRASS MOULD  $\varnothing 80/90 \times 40\text{ mm}$  high following BS
- E055-13** PLASTIC MOULD  $\varnothing 65/75 \times 40\text{ mm}$  high following DIN

### SPARES

- E046N**  $\varnothing 1.13\text{ mm}$  hardened needle (EN 196-3)
- E046-01N**  $\varnothing 1\text{ mm}$  hardened needle (ASTM)
- E055-05** Plastic mould  $\varnothing 60/70 \times 40\text{ mm}$  high following ASTM
- E055-07** Glass base plate
- E055-10** Plastic mould  $\varnothing 70/80 \times 40\text{ mm}$ . high following EN, NF
- E042-06N** Probe 300 g to EN 196-3
- E044-48N** Tang to fix the needle to the probe
- C127-11** Thermo-paper roll for printer (pack of 10 rolls)

## WATER PERMEABILITY OF ONE-COAT RENDERING MORTARS WITH SUBSTRATES

**E035-10**

### WATER PERMEABILITY DETERMINATION APPARATUS

STANDARD: EN 1015-21



This apparatus is used to determine the water permeability in one-coat rendering mortars with substrates.

It is composed by a metallic cone having base diameter of 200 mm and a reference mark at 100 mm.

A glass burette 1000 ml capacity with 1 ml graduations is fixed up the cone through a suitable base with rod and clamps.

**Dimensions:** 1400x300x300 mm approx.

**Weight:** 10 kg approx.

**E035-10**

## LOSS-ON-IGNITION OF CEMENT AND BUILDING LIME, AND CONTENT OF CHLORIDE, CARBON DIOXIDE AND ALKALI INTO THE CEMENT

STANDARDS: EN 196-2 | EN 196-21 | EN 459-2

A muffle furnace is used to oxidize the sample in air at  $975 \pm 25$  °C.

Technical details: see mod. A024N, p. 25 section Aggregates.

**A024N**

## WORKABILITY TEST DETERMINATION FOR GROUT OR MORTAR FLOW

**E059**

### FUNNEL GROOVE

#### CONSISTENCY OF GROUTS

STANDARDS: EN 13395-2 | UNI 8997

Used to determine the consistency of the expansion premixed cement mortars for anchorages, mixed with water, classified of super-fluid type. The apparatus consists of a metal groove with a funnel fixed on one end. Supplied complete with graduated rule, spirit level and feet.

**Dimensions:** 960x210x400 mm

**Weight:** 10 kg approx.

**E059**
**E060**

**E060-01**
**E060-03**

DETERMINATION OF THE FREE EXPANSION IN PLASTIC PERIOD, and of the exudation quantity of the mixing water on expansion pre-mixed mortars for anchorages, mixed with water.

STANDARDS: UNI 8996, 8998

The equipment consists of:

**E060** Bridge of dual measure, formed by a steel square straightedge with two adjustable measure screws.

**E060-01** Fix caliper at two steps, having heights of 100 and 107 mm

**E060-03** Metallic container  $\varnothing$  99x120 mm with 3 hermetic covers.

## E061N CALORIMETER

### HEAT OF HYDRATION OF CEMENT

STANDARDS: EN 196-8 / ASTM C186

Used to determine the heat of hydration of low heat Portland and hydraulic cement.

The apparatus consists of a Dewar flask contained in an insulated material and housed in a wooden box which is hinged so that the flask can be easily removed or replaced.

A **second hinged wooden box** contains the first one, granting a better insulation, as expressly requested by the a.m. Standards. The Calorimeter is supplied complete with a constant speed electric stirrer, and filler glass funnel.

The standard supply **does not include**:

- the thermometer (to be selected from digital models; see accessories)
- the propeller (selecting it from the specific Standard; see accessories)

which must be ordered separately.

**Power supply:** 230V 1ph 50Hz 150W

**Dimensions:** 350x250x680 mm

**Weight:** 12 kg approx.

#### NEEDED ACCESSORIES

**E062-04** DIGITAL THERMOMETER. Resolution: 0.01 °C.  
Complete with probe, or:

**E062-04N** DIGITAL THERMOMETER. Resolution: 0.001 °C.  
- Memory for 10000 readings  
- Displays, stores and prints:  
min, max, mean values, delta T  
- Alarm if limit values are exceeded  
- Battery operated

**E061-11** PROPELLER, conforming to  
ASTM C186 Specifications, or:

**E061-12** PROPELLER, conforming to  
EN 196-8 Specifications.

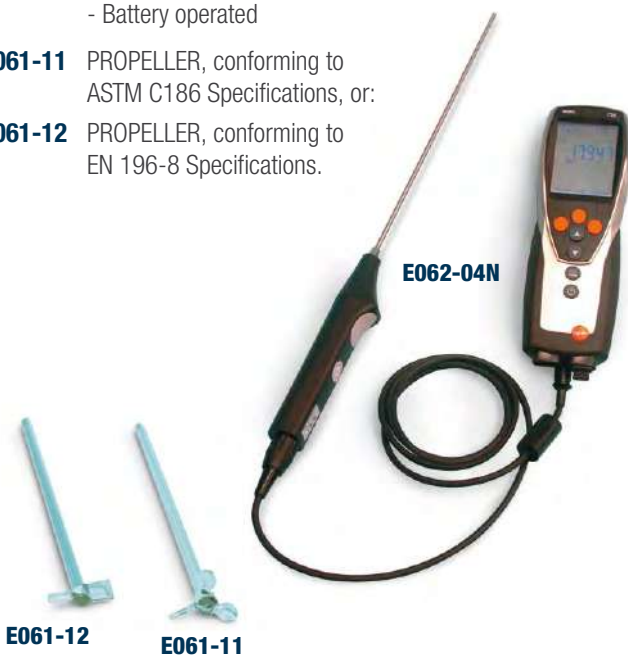

**E061N Open + E062-04**

#### SPARES

**E062-01** Dewar flask

**E062-03** Filler glass funnel

## E062-10 LANGAVANT CALORIMETER

STANDARD: EN 196-9

Used to measure the heat of hydration of cements by means of semi-adiabatic method.

The equipment consists of:

Testing calorimeter, calibrated, Ø 160 by 350 mm

Reference calorimeter (same of the testing one), without certificate.

50 mortar box and 20 sand bags.

Measuring system complete with two temperature probes, modem, software to record temperature, analyze and display data with wireless transmission to modem.

To perform the test a PC is required



**E062-10**

#### ACCESSORY

**V300-19** PARAFFIN WAX with melting point 55 °C to coat the glass parts which are in contact with the hydrofluoric acid.  
Pack of 5000 g.

**E070  
AUTOCLAVE**
**SOUNDNESS (EXPANSION) OF PORTLAND CEMENT**

STANDARDS: Comparable to ASTM C151 | AASHTO T107

It consists of a high pressure boiler made from special alloy steel, inside Ø 154x430 mm high, receiving a holding rack for 10 cement specimens. The heating system is achieved by electric resistances. The separate control panel encloses a **digital thermometer** to visualize the boiler temperature, pressure gauge scale 0 - 600 psi with built in pressure regulator and power switches.

Supplied complete with rack for holding the specimens and safety valve with PED Cat. certificate according to the 97/23/CE Standard. Not sealeable on CE market.

**Power supply:** 230V 1ph 50Hz 3500W 295psi

**Dimensions:** 490x490x980 mm

**Weight:** 150 kg approx.

**E070**

Rack for specimens

**E075**

**E075-01**
**E075 with E075-10**

**E075-10**
**MOULDS FOR SOUNDNESS (EXPANSION) AND SHRINKAGE TESTS** (with length comparators, see next page)

Available models:

**E072**

STANDARD: ASTM C490

TWO GANG PRISM MOULD to produce 25x25x250 mm specimens for expansion tests in autoclave.

Complete with 4 steel inserts. **Weight:** 6 kg approx.

**E073**

STANDARD: BS 1881, 6073

TWO GANG PRISM MOULD to produce 75x75x254 mm specimens.

Complete with 4 steel inserts. **Weight:** 9 kg approx.

**E072-01**

CONTACT POINTS stainless steel, spare for E072 and E073 moulds.

Pack of 10 pieces.

**E073**
**E072**
**E072-01**
**E075**
**THREE GANG PRISM MOULD**
**FOR 40.1x40x160 MM MORTAR SPECIMENS**

STANDARD: EN 12617-4

Comparable to: ASTM C438, NF P15-433

Used for the determination of linear shrinkage of cement mortar.

Manufactured from steel with hardness over 200 HV.

All surfaces are grinded and all parts are marked with an identification number for a correct assembling.

A part-number is engraved on each mould and a Certificate of Conformity is supplied along with.

Complete with 6 steel inserts and fixing screws.

**Weight:** 8.6 kg approx.

**SPARE**

**E075-01** Contact points, stainless steel, complete with fixing screw. Pack of 12

**ACCESSORIES**

**E075-10** STANDARD: EN 12808-4

SPACER, teflon made, dimensions 15x40x160 mm to put into the chamber of the E075 mould, to produce 10x40x160 mm specimens for shrinkage tests as per EN 12808-4 Standard.

Pack of 6 spacers.

**E075-11** INSERTS, for the 10x40x160 mm specimen.

Standard: EN 12808-4

Pack of 12 inserts.

**E107** STANDARDS: NF P15-434 / DIN 1164  
THREE GANG PRISM MOULD to produce 40x40x160 mm specimens. Made from steel 55 HRB. Complete with 6 inserts. **Weight:** 8 kg approx.

**E113** STANDARD: NF P18-427  
THREE GANG PRISM MOULD to produce 70x70x280 mm specimens. Made from steel 55 HRB. Complete with 6 inserts. **Weight:** 17 kg approx.

**E107-01** CONTACT POINTS, spare for E107 and E113 moulds.  
Pack of 12 pieces.



## LENGTH COMPARATOR

STANDARDS: EN 12617-4, 1367-4, 12808-4 | ASTM C151, C490 | NF P15-433, P18-427 | BS 1881:5, 6073 | DIN 1164

Used to measure the length variations of mortar specimens after autoclave soundness tests. The top beam is adjustable to suit the specimen's length.

It also measures the linear shrinkage of specimens having different dimensions like:

40x40x160 mm EN 12617-4, EN 12808-4, ASTM C348, UNI 6687, NF P15-433, DIN 1164

25x25x250 mm ASTM C490

70x70x280 mm NF P18-427

75x75x254 mm BS 1881, 6073

50x50x200 mm EN 1367-04

Supplied **without reference rod** (see accessories)

**Dimensions:** Ø 180x450 mm

**Weight:** 10 kg approx.



## MODELS

### E077 KIT

LENGTH COMPARATOR with Analogic Dial Indicator, 5 mm travel by 0.001 mm divisions, mod. S375

as an alternative:

### E078 KIT

LENGTH COMPARATOR with Digital Gauge 12.7 mm travel by 0.001 mm divisions mod. S382-01, complete with battery and RS232 connection to PC.

## ACCESSORY for mod. E078 KIT

**S382-13** CABLE to connect S382-01 and S383 to PC through USB port for direct visualization and recording of the measurement.

## ACCESSORIES for E077 KIT and E078 KIT

**E078-04** REFERENCE ROD, Invar, for 40x40x160 mm specimens.  
Standards: EN 12617-4, EN 12808-4, NF P15-433

**E078-01** REFERENCE ROD, Invar, for 25x25x250 mm and 75x75x254 mm specimens.  
Standards: ASTM C490, BS 1881, UNI 8520

**E078-03** REFERENCE ROD, Invar, for 70x70x280 mm specimens.  
Standard: NF P18-427

**E078-06** REFERENCE ROD, Invar, for 50x50x200 mm specimens.  
Standard: EN 1367-04

**E078-05** REFERENCE ROD, Invar, 280 mm long.



## SOUNDNESS OF CEMENT AND LIME

STANDARDS: EN 196-3 | EN ISO 9597 | BS 6463 | NF P15-432  
UNE 80102

### E064N

#### LE CHATELIER WATER BATH

Constructed with stainless steel inside chamber and exterior case in painted steel sheet, it can hold up to 12 Le Chatelier moulds (to be ordered separately) in the removable rack, supplied with the bath. The bath reaches the boiling point in approx. 30 minutes. Now an original device keeps the bath temperature at the boiling point, by avoiding the water evaporation and assuring that Le Chatelier moulds remain covered by the water during all the test execution.

**The bath is equipped with security device which cuts the power out in case of overheating of the resistance due to lack of water.**

**Power supply:** 230V 1ph 50-60Hz 1800W

**Dimensions:** 405x265x205 mm

**Weight:** 7 kg approx.



E064N

Rack detail with E065

### E066

#### LE CHATELIER MOULD

Made from a brass spring tensioned split cylinder having internal diameter of 30 by 30 mm high, with two pointers 150 mm long.

**Chromed finishing.**

Used to determine the cement expansion (soundness) either in cold and in boiling water.

**Weight:** 30 g



E066

E065

### E065

#### LE CHATELIER MOULD INDIVIDUALLY TESTED

Similar to mod. E066, but with pointers bigger sized, granting a higher number of test utilisations (about 10 times more) within the tolerances requested by EN Specifications.

**Chromed finishing.**

The moulds are checked one by one with engraved a serial number for an easier identification of each mould, they perfectly meet EN 196-3 Specification.

#### ACCESSORIES

**E066-01** GLASS PLATE 50x50 mm to cover the mould. Pack of 2 pieces.

**E066-02** WEIGHT: 100 g to be placed over the glass plate.

**E066-03** EXTENSIBILITY of mould apparatus to check the elasticity of the split cylinder of the mould. Complete with 300 g weight.

**E066-04** TAMPING ROD 17 mm diameter. Weight: 70 g



### E082

#### PAT TEST

#### SOUNDNESS OF HYDRATED LIME AND GYPSUM PLASTERS

STANDARDS: EN 459-1 | BS 890, 1191

Utilized for the determination of the soundness of hydrated lime, gypsum and building plasters.

Consisting of a brass ring mould, 100 mm diameter by 5 mm deep. The mould has an inside taper of 5°.

Supplied complete with glass base plate.

To perform one test, three moulds are required.



E082

## E081-10 STEAM BATH

### SOUNDNESS OF BUILDING LIME DETERMINATION

STANDARD: EN 459-2

This bath is used for the determination of the soundness of building limes subjected to steam action at atmospheric pressure for 180 minutes time.

The steam bath, all stainless steel made, holds up to 12 Le Chatelier moulds, approx. 50 mm over the water level.

Two heating elements of 1200W and 200W reach the water boiling point in 30 minutes; now a timer disconnects the 1200W element, and the water temperature is maintained by the second element, as requested by the Standard.

The cover has a device avoiding the condensed water to drop on the specimens.

**Power supply:** 230V 1ph 50-60Hz 1400W

**External dimensions:** 455x215x350 mm

**Inner dimensions:** 300x150x260 mm

**Weight:** 9 kg approx.

### ACCESSORIES

**E066** LE CHATELIER MOULD Technical details : see p. 398

**E066-01** GLASS PLATE, 50x50 mm. Pack of 2 pieces.

**E066-02** WEIGHT, 100 g.

**E066-03** EXTENSIBILITY of mould apparatus.

**E066-04** TAMPING ROD, Ø 17 mm x 70 g weight.



E081-10

## E082-11N WATER VAPOUR PERMEABILITY TEST CELL

STANDARD: EN 1015-19

Used to determine the water vapour permeability of hardened rendering and plastering mortars.

Manufactured from PVC material, resistant to corrosion, it has an opening of approx. 0.02 m<sup>2</sup>, on which the test sample is sealed

**Dimensions:** Ø 150 mm by 55 mm

**Weight:** 600 g approx.



Disassembled

E082-11N

Assembled

## POTENTIAL ALKALI REACTIVITY OF CEMENT-AGGREGATE COMBINATIONS

E067-05

### MORTAR BAR CONTAINER

STANDARDS: ASTM C227, C1260, C1567 | UNI 8520-22

This test method covers the determination of the potential alkali reactivity of cement-aggregate combinations (mortar bar method). The device is composed by an acrylic cylinder container with a stainless steel rack.

Dimensions: Ø 170 mm x 450 mm

Weight: 3 kg approx.

 **Note:** Prism moulds, length comparator and accessories: see p. 397

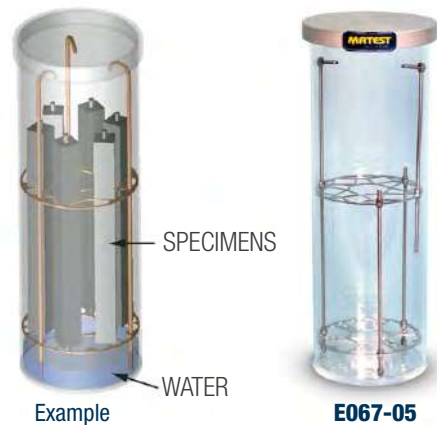

E081

### MORTAR WORKABILITY APPARATUS

STANDARDS: EN 413-2 | NF P18-452

Designed to test concrete mortar for dynamic workability and also to ensure optimum proportioning of mortar constituents (sand, water, cement, as well as cement/sand and water/cement ratios) compatible with given application. Suitable also for checking possible improvement when admixing a plastifier, or for comparing two mortar types. The unit consists of a prismatic receiver divided into two unequal volumes by a removable partition, and by an electric vibrator. The fresh mortar is poured in the large volume place, the separating partition is removed and the vibrator starts automatically. As a result of vibrations, mortar flows from the large volume to the small one, in a time which is a function of the workability of the mortar.

**Power supply:** 230V 1ph 50Hz 110W

**Dimensions:** 400x200x200 mm

**Weight:** 18 kg approx.

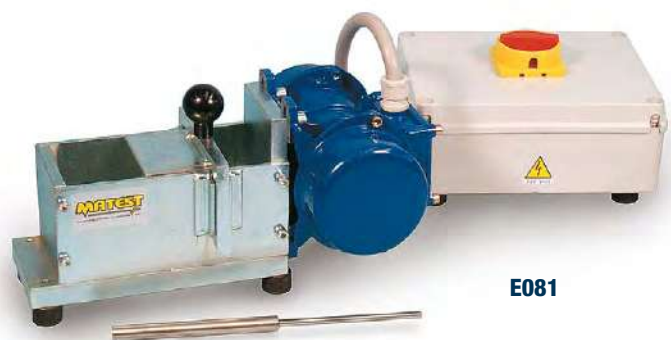

E081

## WORKABLE LIFE AND CORRECTION TIME OF FRESH MORTAR

STANDARD: EN 1015-9 Method A

## PROTECTION AND REPAIR OF CONCRETE STRUCTURES.

### DETERMINATION OF STIFFENING TIME

STANDARD: EN 13294

#### E083-10

**LEVER SUPPORT** (drill-holder type), complete with washer and penetration rod brass made, clamp and locking support. Used for the workable life and correction time of fresh mortar, and for the determination of stiffening

time on products and systems for the protection and repair of concrete structures. Complete with container.

**Dimensions:** 380x300x500 mm

**Weight:** 12 kg approx.

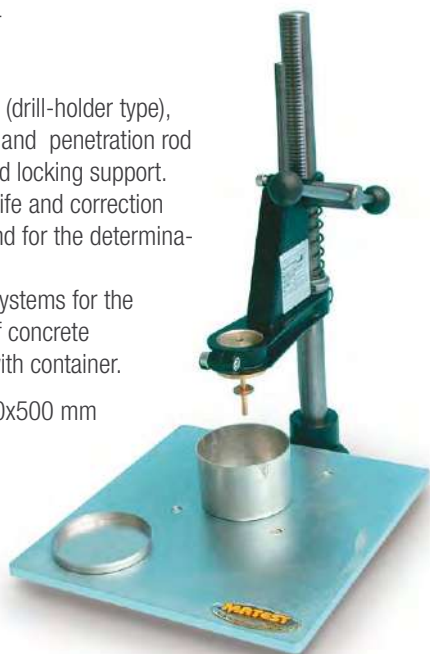

E083-10

#### SPARE

**E083-11** CONTAINER, rigid aluminium made, Ø 90 by height 60 mm, complete with cover.

#### ACCESSORY

**V075-12SP** DIGITAL BALANCE, 16 kg capacity and 0.1 g division, with hold of the breaking load and with tare.

V075-12SP

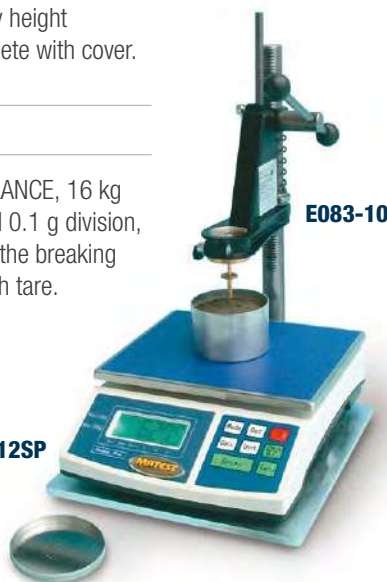

E083-10

#### E067

### CRACKING TEST MOULD

STANDARD: NF P15-434

Used to produce ring-shaped specimens designed for cracking tests on hydraulic binders.

This test consists of measuring the formation time of a crack on the test specimen.

**Weight:** 8 kg



E067

#### E083

### PLUNGER PENETRATION APPARATUS

MASONRY CEMENT, BUILDING LIME CONSISTENCY

STANDARDS: EN 413-2, 459-2, 1015-4

Used to determine the consistency of fresh mortar, lime and masonry cement.

The base is foreseen of a device to locate the test cup.

The height of the drop can be accurately adjusted to 100 mm.

Supplied complete with test cup and tamper, both anodized aluminium made.

**Dimensions:** 200x200x700 mm

**Weight:** 8 kg approx.

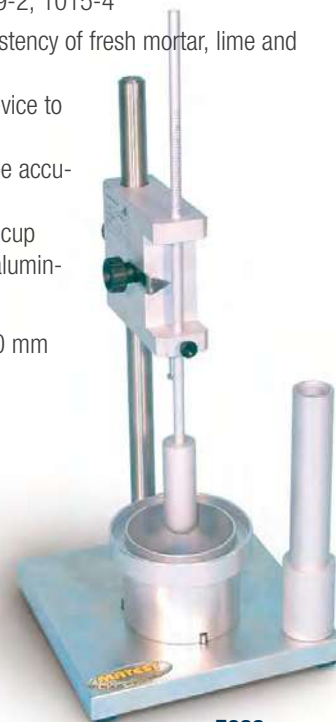

E083

#### E080

### PLASTER EXTENSOMETER

STANDARDS: BS 1191 | UNI 6782

Utilized to measure the linear expansion of a paste of standard consistence. The extensometer comprises an horizontal cradle 100 mm long x 60 mm wide x 25 mm deep closed at one end and open to the other.

The open end is in contact with a dial gauge spindle, so that the lateral expansion of the specimen is measured. The dial gauge has 10 mm travel and 0.01 mm. graduation.

**Dimensions:** 250x80x80 mm

**Weight:** 3 kg



E080

#### A105

### CALCIMETER CARBONATE CONTENT $\text{CaCO}_3$ IN LIMESTONE AND LIME MARL

Specifications: see p. 60

#### E082-01N

### WATER RETENTION

STANDARDS: EN 413-2

Used for determining the water retention of masonry cements.

Made from rigid plastic inside Ø 100 ± 1 mm, inside height 25 ± 1 mm

**Weight:** 300 g approx.



E082-01N



A105

## FLOW TABLES

### FOR FLOW AND WORKABILITY TESTS OF MORTAR AND LIME

STANDARDS: EN 459-2, EN 1015-3, EN 13279-2 | ASTM C230 | \*comparable to BS 4551-1

To perform this test, a specimen contained in a cone mould is placed on a metal surface which is then raised and dropped from a known height, after releasing the specimen from the mould.

The equipment consists of a circular top table with spindle, tripod, bronze flow mould and tamper. The apparatuses to EN Standards are equipped also of a filling hopper. Motorized models foresee an automatic digital drop counter.

The flow tables mod. E090 KIT and E090-01 KIT meet to both the EN 459-2, EN 1015-3 and EN 13279-2 Specifications.

**Power supply (motorized models):** 230V 1ph 50Hz 150W

**Weight:** 25...60 kg approx.



**E090 KIT**



**E090-01 KIT**

## ACCESSORIES

**E087-01** FLOW CALLIPER to ASTM and BS Standards, for measuring the diameter of the sample. Brass made. Weight: 450 g.

**E090-08** FLOW CALLIPER to EN 459-2 and EN 1015-3 Specifications.



**E087-01**



**E090-08**



**E086 KIT**



**E087 KIT**

## SPARE

**E085-07** FILLING HOPPER to the mould. Standard: EN 459-2.

Model	Standard	Operated		Table Ø mm	Drop height mm	Spare mould	Spare tamper
		Hand	Motorized				
<b>E086 KIT</b>	ASTM C230 *(BS4551-1)	▼		254	12.7	<b>E087-05</b>	<b>E087-06</b>
<b>E087 KIT</b>	ASTM C230 *(BS4551-1)		▼	254	12.7	<b>E087-05</b>	<b>E087-06</b>
<b>E090 KIT</b>	EN 459-2 EN 1015-3 EN 13279-2	▼		300	10	<b>E085-05</b>	<b>E085-06</b>
<b>E090-01KIT</b>	EN 459-2 EN 1015-3 EN 13279-2		▼	300	10	<b>E085-05</b>	<b>E085-06</b>

## E092N KIT

## MIXMATIC

## AUTOMATIC PROGRAMMABLE COMPUTERIZED MORTAR MIXER HIGH PERFORMANCE

STANDARDS: EN 196-1, EN 196-3, EN 413-2, EN 459-2, EN 480-1 | DIN 1164-5, DIN 1164-7 | ASTM C305M | AASHTO T162

Mixmatic has an extremely sturdy fabricated frame for an intensive laboratory use. Complete with stainless steel polished beater, mixing bowl and automatic sand dispensers having dimensions and geometry to grant the correct sand insertion, without residual and disaggregation between fine and coarse portions. Dispenser for additives (see accessory mod. E092-05). Dispenser for automatic water addition (see accessory mod. E092-06).



E092N KIT

## MAIN FEATURES

- Rugged design
- Planetary transmission for silent and low maintenance operation.
- Transparent CE-conform protection of the mixing area, to allow the mixture looking during the test.
- Digitally controlled rotation speed..
- Easy and fast bowl insertion and removal.
- Safety system of bowl presence and correct position to avoid dangerous working, with double sensor of removed bowl with load/unload sequential discrimination.
- Emergency stop button.

## Firmware:

- Different automatic programmable mixing cycles conforming to the a.m. Standards.
  - The operator can also program up to 30 automatic personalized mixing cycles, easy to set through Touch Screen.
  - Synchronised acoustic signals with cycle steps.
  - Electronic control unit with touch screen colour display, that runs like a standard PC based on Windows operating system for the management and analysis of the data, test results, graphs. The touch-screen icon interface allows an easy set up of the parameters and immediate execution of the test. Direct connection to Intranet (connection to a LAN network) and Internet to establish a remote communication and receive an immediate diagnostic analysis of the potential problem from Matest technicians, or for updates of the software.
- Hardware technical details: see p. 18
- Unlimited memory storage with: 2 USB ports, 1 SD card slot, RS232/485 serial port.
- Rotational motor feeded through inverter to grant the max. precision of the rotational speed, adjustable by the operator on the display.
  - Possibility of manual mixing cycle.
  - Possibility to select different languages.

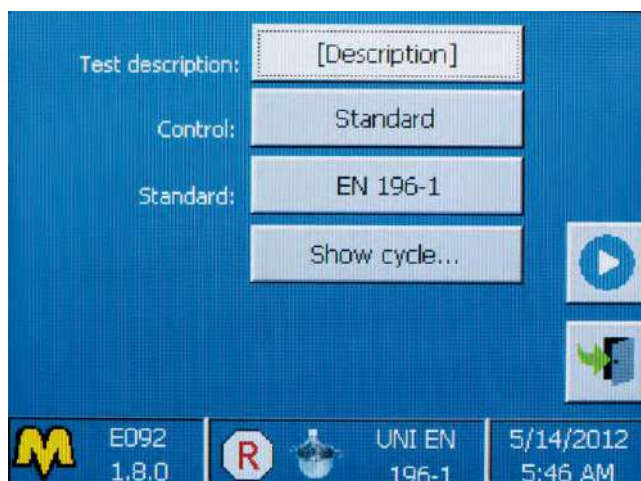

Selection of the Standard

- Detailed indication of all the times (elapsed from the test start, residual to end test, elapsed from and test and bowl removal), state of cycle development with analogue bar, speed, active phase (sand, water), test state (correct execution or test interruption with lost results), type of current test.

**Power supply:** 230V 50-60Hz 1ph

**Dimensions:** 530x620x780 mm

**Weight:** 85 kg approx.

**E092N KIT MIXMATIC**

Test execution

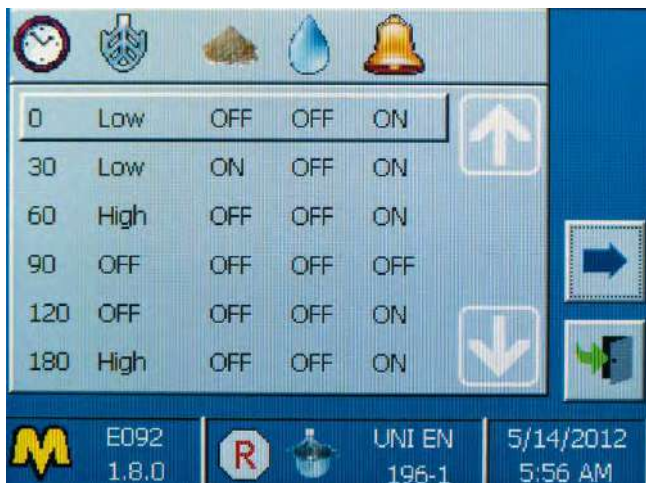

Personalized cycle composition

**ACCESSORIES**

- E092-05** DISPENSER (supplementary) with hopper to ease the manual introduction of additives etc. into the bowl, also during the mixing phase.
- E092-06** DISPENSER (supplementary) with hopper for the automatic introduction (managed by the software) of water into the bowl, also during the mixing phase.
- E092-10** SPARE stainless steel bowl.

- E097-01N** REFERENCE SAND, size from 0.08 to 2 mm to EN 196-1 Standard.  
 Bag of 1350 g. Pack of 16 bags for total of 21.6 kg



- E097-02** GRADED NATURAL SILICA SAND, type Ottawa, to ASTM C109, C778 Standards. Bag of 25 kg



Use examples



## MORTAR MIXERS

STANDARDS: EN 196-1, EN 196-3, EN 413-2, EN 459-2, EN 480-1 | DIN 1164-5 | ASTM C305M | AASHTO T162



**E093 + E095-03**

### MODELS

#### E093 AUTOMATIC MORTAR MIXER

This very robust mixer is expressly designed for the efficient mixing of cement pastes and mortar, with **four** automatic sequences of mixing cycle, in compliance with:

EN 196-1, EN 196-3, EN 480-1, ASTM C305M Specifications.

Bowl capacity is 4.7 litres

Two speeds can be selected:

140 or 285 rpm for the revolving action

62 or 125 rpm for the planetary action

It is possible to select the manual working, or one of the two automatic programs.

By operating automatically on changes of speed, stops and mixing sequences, outlined by acoustic signal, the unit performs the mixing cycle.

The unit is equipped of an automatic sand dispenser which fills the sand into the mixing bowl for a period of 30 seconds (EN 196-1 program). Complete with safety door conforming to CE Safety Directive; if opened it automatically stops the machine.

Supplied complete with stainless steel bowl, bajonet coupling between beater and shaft, but **without beater** which has to be ordered separately (see mod. E095-03 or E095-04).

**Power supply:** 230 V 1ph 50 Hz

**Dimensions:** 340x460x700 mm.

**Weight:** 45 kg approx.



**E094**

#### E094 MORTAR MIXER

Basically similar to mod. E093, but not equipped of automatic program, sand dispenser and safety door.

Two speeds can be selected. Supplied complete with stainless steel bowl, but **without beater** which has to be ordered separately.

This mixer can be supplied only to extra CE markets.

**Dimensions:** 340x460x500 mm

**Weight:** 40 kg approx.



**E094SP**

#### E094SP MORTAR MIXER **NEW**

Same as mod. E094 but equipped also with sand dispenser.

## E095 MORTAR MIXER

Basically similar to mod. E094, but complete with sand dispenser and safety door to CE Safety Directive.

Two speeds can be selected. Supplied complete with stainless steel bowl, but **without beater** which has to be ordered separately.

**Dimensions:** 340x460x500 mm

**Weight:** 44 kg approx.

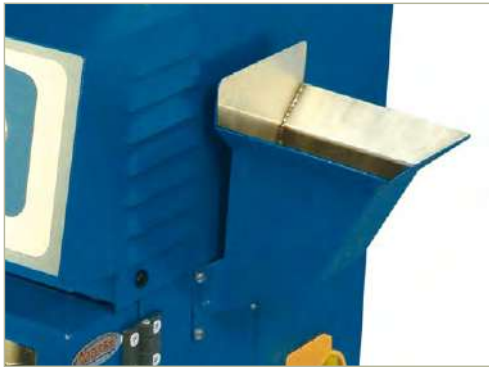

E096-01



E095

### ACCESSORIES FOR E093, E094, E095 MIXERS

**E095-03** STAINLESS STEEL BEATER with bayonet fittings.

**E095-04** STAINLESS STEEL BEATER with bayonet fittings. The beater is accurately polished to eliminate the porosities.

**B028-03** WHISK BEATER, thin wire, stainless steel, for mixing admistured and other materials.

**E096-01** DISPENSER WITH HOPPER, to ease the manual introduction of water, additives etc. into the bowl also during the mixing phase. Accessory to mod. E093 and E095 mixers.

**E097-01N** REFERENCE SAND, size from 0.08 to 2 mm to EN 196-1 Standard.

Bag of 1350 g. Pack of 16 bags for total of 21.6 kg

**E097-02** GRADED NATURAL SILICA SAND, type Ottawa, to ASTM C109, C778 Standards. Bag of 25 kg



B028-03

### SPARE PARTS FOR E093, E094, E095 MIXERS

**E095-01** Stainless steel bowl

**E095-05** Bajonet coupling between beater and shaft



E097-02



E097-01

E095-03

E095-05

E095-01

E095-04



**E142**
**DIGITAL PULL-OFF (BOND) STRENGTH TESTER. CAPACITY: 16 KN**

STANDARDS: EN 1542, EN 1348, EN 1015-12, EN 13687-2, EN 13963, EN 14496 / NF P18-858 / BS 1881:207

This dynamometer measures the adhesive force and the tensile strength of two layers of materials (concrete, facing plasters, mortars, building plasters, lime etc.) and is particularly suitable for applications concerning testing repairs of any structure where the bond strength between two layers is an essential factor.

Compact, light, for use in any location, this Pull-Off Tester is fitted with a load cell and high resolution large digital display unit; it is therefore suitable for measurements from low loads up to 16 kN, granting a wide working range and ideal for a large number of applications and materials. The direct tensile force is applied by rotating the hand wheel.

The three feet of the unit can be fixed in the **large** position (overall dimensions 176 mm diameter, see drawing "A") with very stable bearing, or in the **compact** position (overall dimensions 92.5 mm diameter, see drawing "B"), to perform tests in narrow spaces, or for specimens close one to the other.

## Specifications:

- Load capacity: 16 kN
  - Resolution: 10 N
  - Working range: 0.25 to 16 kN
  - Accuracy and repeatability: better than  $\pm 1\%$
  - Complete with traceable calibration certificate
  - Battery operated
  - Serial port for PC connection
  - Hand wheel rounds: 60 with mechanical round/counter
  - Graphic indication of the applied load rate
  - Seat ball assuring axial/central load application
- Supplied complete with carrying case, but **without** accessories to perform the test, which have to be ordered separately.

To perform the test a common electric drill is required.

**Dimensions:** 410x210x270 mm

**Weight:** 5.5 kg approx.



**E142**  
with feet  
in large position

**E142-01**
**DIGITAL PULL-OFF TESTER CAPACITY: 5 KN**

Identical to mod. E142 but with load cell and digital display range 0-5 kN for more accurate measurements on low strength values



**E142**  
in aluminium case

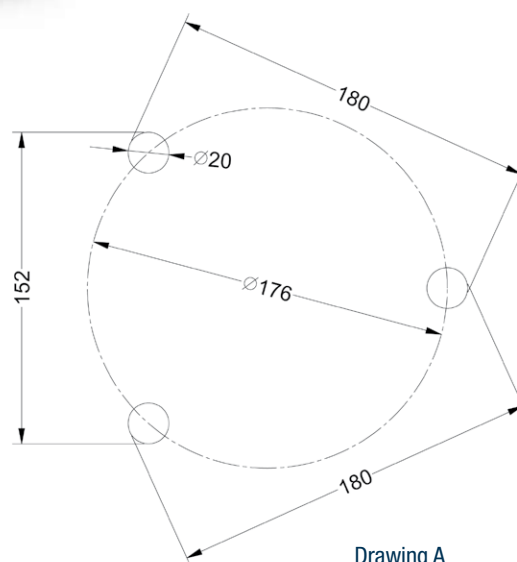

Drawing A

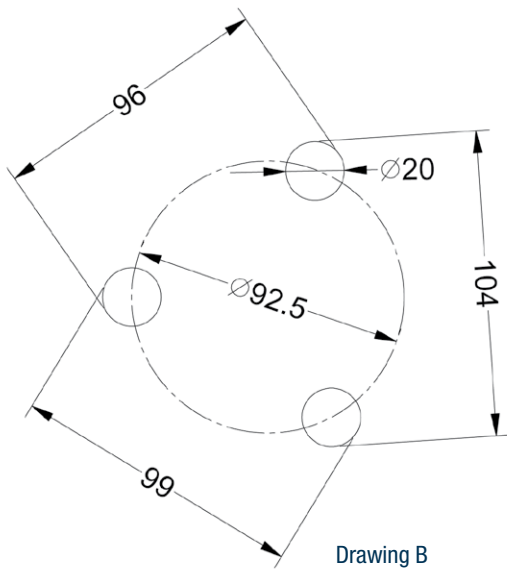

## ACCESSORIES

- E142-10** SOFTWARE complete with connection cable to download test results to the PC
- E143** ADHESION TEST ALUMINIUM DISC 20 mm  $\varnothing$  by 21 mm thick (n° 10 pieces)
- E143-01** ADHESION TEST ALUMINIUM DISC 50 mm  $\varnothing$  by 31 mm thick (n° 10 pieces)
- E143-10** ADHESION TEST STAINLESS STEEL DISC 50 mm  $\varnothing$  by 21 mm thick (n° 10 pieces) It conforms to EN 1015-12 Specification.
- E143-13** ADHESION TEST ALUMINIUM DISC, square, 50x50 mm, 21 mm thick (n° 10 pieces)  
Standard: EN 1348
- E143-11** CYLINDRICAL RING, having truncated cone shape, inside  $\varnothing$  50 mm  
Standard: EN 1015-12
- E143-02** DRILL BIT WITH CENTERING BIT, 20 mm diameter, for the preparation of the test surface.
- E143-03** DRILL BIT WITH CENTERING BIT, 50 mm diameter, for the preparation of the test surface.
- E143-12** ACRYLIC ADHESIVE GLUE, 300 ml. cartridge, complete with small pump and nozzles.



## SPARE

- E143-09** Tie rod with spheric head for Disc/Dynamometer coupling.



**E102**
**THREE GANG MOULD**

FOR 40.1x40x160 MM PRISMS

STANDARDS: EN 196-1 | EN ISO 679

Steel manufactured with **hardness of inside walls over HV 200**, it meets the dimensional tolerances to EN 196/1 Standard. All surfaces are grinded and all parts are marked with an identification number for a correct assembling. A part-number is engraved on each mould and a Certificate of Conformity is supplied along with.

**Weight:** 8560 g.

**E103**
**THREE GANG VERIFIED MOULD**

FOR 40.1x40x160 MM PRISMS

STANDARDS: EN 196-1 | EN ISO 679

Identical in shape to mod. E102, but manufactured from heavy duty steel **with hardness of inside walls over HV 500** (EN196/1 Specifications recommend hardness HV 400). This high hardness value keeps the mould within the tolerances requested by Spec. for many tests, granting very long utilisation life.

All parts are marked with an identification number for a correct assembling. Each mould is individually verified in the dimensional tolerances, hardness, squareness, flatness and roughness with instruments periodically certified by Namas Centre or equivalent. A part-number is engraved on each mould, and a Certificate of Conformity is supplied along with.

**Weight:** 8560 g.

**E105**
**THREE GANG MOULD**

FOR PRISMS 40x40x160 MM

STANDARDS: NF P15-413 | ASTM C348 | DIN 1164, 1060

Made from steel, hardness 55 HRB, it conforms to the above mentioned Specifications.

**Weight:** 8 kg approx.

**ACCESSORIES**

**E106** FEED HOPPER, used to fill the mould E102, E103, E105 when it is mounted on the Jolting machine E130, E131 Made from cast aluminium. Weight: 1 kg

**E102-02** LARGE AND SMALL SCRAPER to EN 196-1

**S200-11** STRAIGHT EDGE 300 mm long.

**E102-03** GLASS PLATE 220x190x6 mm to cover the mould.

**E102**
**E102-11**
**SIX GANG MOULD FOR 40.1x40x80 MM**

STANDARD: EN 12808-5

DETERMINATION OF WATER ABSORPTION on grouts for floor or wall installation of ceramic tiles.

Identical to mod. E102, but equipped with three stainless steel partitions, positioned in the middle of the gangs, to obtain six gangs having dimensions 40.1x40x80 mm approx.

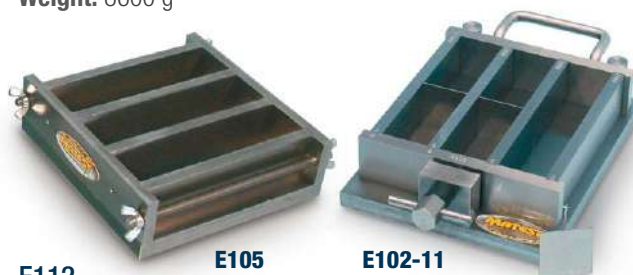
**Weight:** 8600 g

**E105**
**E102-11**
**E112**
**THREE GANG MOULD FOR 70.7x70.7x282.8 MM**

STANDARD: NF P18-401

Made from steel. **Weight:** 17 kg approx.

**E111**
**BRIQUETTE MOULD**

STANDARDS: ASTM C190, C307 | AASHTO T132

Accurately machined it conforms to the above Specifications and is easily collapsible. Complete with base. **Weight:** 3 kg

**E110-01**
**THREE-GANG MOULD FOR CUBE 40 MM**

Ground steel mould for three cubes 40mm sides.

**Dimensions:** 190x100x47 mm approx.

**Weight:** 2 kg approx.

**E112**
**E110-01**
**E110**
**E111**
**E110**
**50 MM THREE GANG CUBE MOULD**

Made from steel, hardness 55 HRB, it can be also used for soil and other materials. **Weight:** 6 kg approx.

## E130 JOLTING APPARATUS

STANDARDS: EN 196-1 | EN ISO 679

Used to compact cement mortar prisms 40x40x160 mm in the three gang mould, as requested by the above Specifications.

The apparatus, consists of a table holding the mould, seated on a rotating cam driven at 60 revolutions per minute. The jolting group is connected to the table by bayonet joints for quick checking of the weights.

The drop height (15 mm) is adjustable to keep it correct also after intensive uses. The apparatus is supplied with separate control panel including main switch, automatic digital drop counter, start/stop push button.

The apparatus accepts moulds Matest made, and also of other manufacturers.

**Power supply:** 230V 1ph 50Hz 500W

**Dimensions:** 1000x380x420 mm

**Weight:** 65 kg approx.

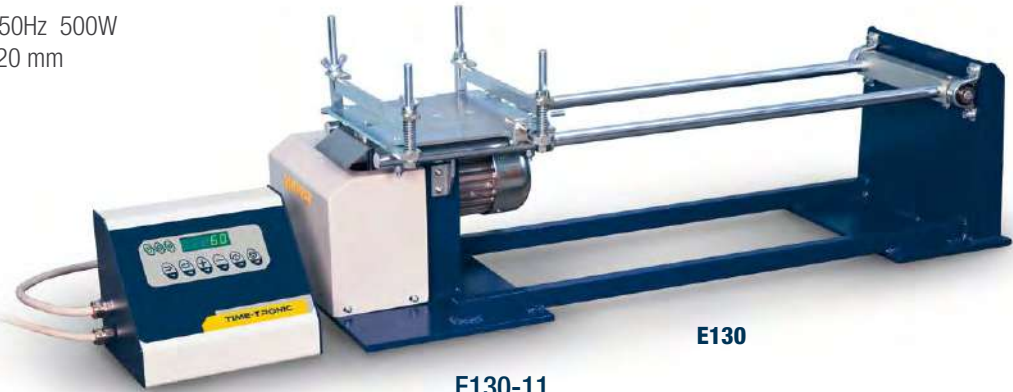

E130



E130-11 + E130

### E130-11 CABINET

Manufactured from sheet steel, internally lined with sound-proofing material for noise reduction, to be used with the Jolting apparatus E130, E131.

Front opening with rear hinges and jacks to facilitate the lifting. Concrete base minimum 1350 x 670 mm is requested.

**Dimensions:** 1300x510x700 mm

**Weight:** 25 kg approx.

## E131N JOLTING APPARATUS HIGH PERFORMANCE

STANDARDS: EN 196-1 | EN ISO 679

Similar to model E130, but manufactured with oversized components, treatments and extremely accurate couplings for intensive use in heavy conditions.

Motor feeded by an inverter to grant the keeping of 60 revolutions per minute in any condition.

**Power supply:** 230V 1ph 50-60Hz 500W

**Weight:** 93 kg approx.



E131N with mould and hopper

## E132 VIBRATING MACHINE FOR 70.7 MM CUBE MOULDS

STANDARD: BS 4550

The mould is mounted on a vibration platform with excentric mechanism. The machine is supplied complete with separate control panel with timer, but **without cube moulds** to be ordered separately.

**Power supply:** 230V 1ph 50Hz 250W

**Weight:** 100 kg approx.



E132 with mould

### E133 CUBE MOULD 70.7 MM

STANDARD: BS 4550

Made from steel with dimensions as specified by above Standard.

Complete with base plate (three moulds required for each test).

**Weight:** 3 kg approx.

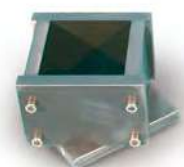

E133

## WATER BATHS FOR CEMENT CURING AND FOR GENERAL LABORATORY PURPOSE

STANDARDS: EN 196-1, 196-8 / ISO 679 / ASTM C109, C511  
Double walled all stainless steel made, with wool insulation and water circulation electric stirrer, the bath ensures an uniform and constant temperature.

Temperature range: from ambient to +60 °C with accuracy of  $\pm 0.4$  °C at 20 °C.

The bath is equipped with digital thermostat and a dual safety thermostat with higher thermic threshold ensuring safe working conditions.

A cooling coil device to be connected to the water net is used when room temperature exceeds the requested one, with possibility to reduce the bath temperature within the room and water net conditions.

The specimens are held by a perforated shelf spaced from the bottom.

### MODELS

#### E136 WATER BATH, 40 LITRES CAPACITY

It can hold over 60 specimens 40.1x40x160 mm

**Internal dimensions:** 510x350x230 mm

**Overall dimensions:** 680x420x420 mm

**Power supply:** 230V 1ph 50-60Hz 1200W

**Weight:** 28 kg approx.

#### E136-01 WATER BATH, 200 LITRES CAPACITY

**Internal dimensions:** 900x600x360 mm

**Overall dimensions:** 1050x680x430 mm

**Power supply:** 230V 1ph 50-60Hz 4000W

**Weight:** 55 kg approx.

#### B052-02 WATER BATH WITH COOLING DEVICE

Similar to mod. E136, but with temperature range: +3 to +95 °C.  
Accuracy of  $\pm 0.4$  °C at 20 °C.

The cooling unit is housed under the water bath.

**Inside dimensions:** 635x360x205 mm

**Outside dimensions:** 800x430x1000 mm

**Power supply:** 230V 1ph 50Hz 1650W

**Weight:** 60 kg approx.



**B052-02**

### ACCESSORY

**E136-10**  
CONTROL THERMOMETER  
range 0-50 °C div. 0.5 °C.



**E136**



**E136-01**

#### E139 CURING CABINET

Both external and internal walls are stainless steel made, and insulated by a 50 mm thick glass wool.

The cabinet has an inner inspection glass door.

Temperature range: from ambient to 60 °C, with digital thermostat.

Humidification achieved through water heating.

A dual safety/thermostat with higher thermic threshold ensures safe working conditions.

**Power supply:** 230V 1ph 50-60 Hz 1000 W

**Inside dimensions:** 620x440x400 mm

**Overall dimensions:** 900x700x800 mm

**Weight:** 60 kg approx.



**E139**

### ACCESSORY

**V165** THERMO-HYGROMETER for humidity and temperature control. Technical details: see p. 592

## E138 LARGE CAPACITY CURING CABINET

STANDARDS: EN 196-1, 196-08 | ISO 679 | ASTM C109, C511

For curing large quantities of mortar, cement and concrete specimens, at controlled humidity and temperature.

Aluminium and polycarbonate made, it is complete with precision digital thermostat and four robust shelves.

The humidity from 90% to saturation is maintained through water nebulizers activated by compressed air, and the temperature by an immersion heater and refrigerator unit (accessory mod. E141)

Temperature range: from ambient to +30 °C, accuracy  $\pm 1$  °C.

The cabinet requires a compressed air source. (see accessory)

**Inside dimensions:** 1090x470x1200 mm

**Overall dimensions:** 1350x570x1600 mm

**Power supply:** 230V 1ph 50-60Hz 2000W

**Weight:** 100 kg approx.



**E138**

### ACCESSORIES for mod. E138

**V206-01** AIR COMPRESSOR, air displacement: 250 litres/min.  
Tank capacity : 100 litres (see p. 598)  
Recommended for standard use.

**V206-02** AIR COMPRESSOR, air displacement: 400 litres/min.  
Tank capacity : 200 litres (see p. 598)  
Recommended for intensive or continuous use .

**E138-11** TUBING AND ACCESSORIES to connect the E138 cabinet to the air compressor

**E134-11** PAN, 240x300x70 mm, polythene made, it accepts up to six 40.1x40x160 mm prisms for curing in water.



**E134-11**

### ACCESSORY for mod. E136, E136-01, E138

## E141 WATER REFRIGERATOR

It cools the water from room temperature up to +10 °C with supply capacity of 2 litre/minute.

Stainless steel made, complete with motor pump, digital thermostat sens. 0.1°C, it is connected to water baths and tanks where a lower temperature than the room one is required.

Complete with tubing and accessories for bath connection.

**Power supply:** 230V 1ph 50Hz 750W

**Dimensions:** 550x500x880 mm

**Weight:** 55 kg approx.



**E141**

## E140 CURING BENCH WITH COOLING HEATING SYSTEM

Suitable for curing large quantities of cement, mortar and concrete specimens at controlled temperature and humidity.

Temperature range: +18 °C to +30 °C with accuracy  $\pm 1$  °C

Humidity range: 95% to saturation

Useful capacity: 540 litres

Fully stainless steel made with insulation panels.

N. 4 access doors with 4 grids, 530x310 mm each, adjustable in height. Thermostatic group including refrigerating unit, compressor, condenser, evaporator, control and safety devices are installed laterally for easy inspections.

The upper side can be used as working bench.

**Power supply:** 230V 1ph 50-60Hz

**Dimensions:** 2250x1010x850 mm

**Weight:** 200 kg approx.



**E140**

## COMPRESSION AND FLEXURAL TESTING MACHINES FOR MORTAR STRENGTH DETERMINATION

In the cement and mortar section we are in the position to supply the widest and most complete range of compression/flexural testing machines today available in the worldwide market, making Matest the leader manufacturer of strength testing machines.

The versatility and flexibility of Matest production range allows the enduser to select a cement compression/flexural frame to be combined with another frame (like for example concrete compression frame) in order to satisfy and to personalize any specific requirement.

The next pages describe:

- Measuring and control systems (p. 413..416)
- Unitronic 50 kN and Unitronic 200 kN universal multipurpose compression/flexural and tensile frames (p. 416)
- Two columns machines with only one measuring range for **compression tests only** and 250kN or 500kN capacity load (p. 418...421)
- Two columns machines with **double measuring range** with the same testing chamber, for **compression and flexural tests**. Ranges: 250kN or 500kN for compression tests, and 15kN for flexural tests (p. 422...425)
- Machines with **double testing chamber** and **two independent measuring ranges**, for **compression** tests in the chamber 250kN or 500kN capacity, and **flexural** test in the chamber 15kN capacity (p. 426)
- Combined groups for compression and flexural tests on mortars, compression/flexural tests on concrete, splitting, block tests; suitable to personalize and satisfy any specific requirement (p. 429)



## C108N DIGITEC | C098N AUTOTEC

**Two-channels computerised graphic display system to control and manage all sorts of automatic (Autotec C098N) and semi-automatic (Digitec C108N) testing machines, for acquisition, display, processing, printing and saving the test data and certificates, with software for remote control from PC.**

SUITABLE TO UPGRADE OR COMPLETE YOUR CONCRETE OR MORTAR COMPRESSION AND FLEXURE TESTING MACHINE  
(also from other manufacturers).

### Specifications Digitec / Autotec:

- 2 analogue-digital channels accepting sensors, transducers or load cells at 2mV/V, allows the connection to two different compression/flexure frames.
- Simple and immediate parameters set up and test execution, menu driven interface.
- Rapid approaching, touching on and breaking of the specimen under direct pump control (Autotec C098N)
- Automatic control of the pace rate (Autotec C098N)
- Continue load display.
- Breaking load detection.
- Automatic elaboration of the specific resistance value.
- Permanent file up to 1000 tests and file of 100 different types of specimens.
- Graphic display with high resolution: 192x64 pixels.
- Selectable measuring force: kN, lb
- Languages: English, French, German, Spanish, Italian, Polish, Czech, Turkish.
- **Class:** 1 accuracy starting from 10% of maximum value, on request from 1% of maximum value.



### APPLICATIONS



Compression and Flexure on Mortars



Compression on concrete



Flexure on concrete



Splitting on concrete cubes and cylinders



## C109N CYBER-PLUS | C104N SERVO-PLUS



**An electronic evolution with 8 analog inputs for compression and flexural testing machines on concrete and mortar.**

Designed with the latest technology, an innovative PC-like Touch Screen system, employed to control and manage all sorts of automatic (Servo-Plus Evolution C104N) and semi-automatic (Cyber-Plus Evolution C109N) testing machines.

To update or complete your compression and flexural testing machine on concrete and mortar (also on Non-Matest brands)



### APPLICATIONS



Compression and Flexure on Mortars



Compression on concrete



Flexure on concrete



Splitting on concrete cubes and cylinders



Tensile on steel

## MAIN FEATURES

- The control unit Cyber/Servo-Plus Evolution runs like a standard PC based on Windows operating system.
- The touch-screen graphical user-friendly interface allows an easy set up of the parameters and an immediate execution of the test.
- High resolution color display, ¼ VGA, offers all the functions of a PC for the management and analysis of data, test results, and graphs.

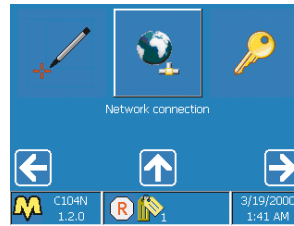

Internet direct connection for remote assistance



Windows operating system



## 3 OPERATING MODES

### 1 Control from user friendly Touch-Screen display

### 2 Large directional arrow-keys for gloved use

### 3 Connection of a keyboard or mouse



Direct connection of the Cyber/Servo Plus Evolution to the Intranet (direct connection to a LAN network) and Internet to establish a remote communication and receive diagnostic analysis of potential problems, the ability to execute the test from distance and provide software updates. Matest technicians will check the unit located abroad to guarantee a prompt and professional assistance.

## MAIN FUNCTIONS

- More intuitive interface which simplifies the use of the machine (test begins after a few simple inputs)
  - Greater calculation ability and data display (on board charts and graphic print-outs)
  - High management capacity for the multilingual framework and international settings (date and time, decimal units, unit of measure).
  - Elastic software which allows the installation of new tests when desired.
  - Profile configuration manager
  - Configuration and calibration supervision of the analog channel
  - Alarms manager
  - Ethernet parameters configuration
  - International settings configuration
  - Hardware diagnosis functions
  - Functions for the software updates and licenses
  - Execution of tests through parameters set up customization
  - Several levels of protection (passwords) to prevent the accessibility to the configuration menus by unauthorized staff.
- Cyber-Plus Evolution C109N and Servo-Plus Evolution C104N** are supplied complete with licenses for the execution of the following tests:
- COMPRESSION on mortar
  - FLEXURAL on mortar
  - COMPRESSION on concrete
  - FLEXURAL on concrete
  - SPLITTING TEST on cylinders and concrete cubes
- In accordance to the following standards: EN, ASTM, BS, NF, DIN etc.
- Technical details, features and accessories: see p. 224**

**S205N**
**UNITRONIC 50 KN**
**UNIVERSAL MULTIPURPOSE TOUCH-SCREEN FRAME**

COMPRESSION/FLEXURAL AND TENSILE FRAME FOR:

- COMPRESSION / FLEXURAL TESTS, 50 kN MAX. CAPACITY LOAD
- TENSILE TESTS, 25 kN MAX. CAPACITY LOAD (see mod. S205-05N)

WITH AUTOMATIC LOAD OR DISPLACEMENT/DEFORMATION CONTROL, for testing:

**Cement / Mortar**

Concrete

Rock and stones

Clay blocks

Metal, plastic, wires, ropes, textiles, papers, adhesives for tiles

Asphalt

Soil

Unitronic technical details and additional specific tests are described at p. 500

**SPECIFIC APPLICATIONS ON CEMENT AND MORTAR:**
**FLEXURAL TEST ON MORTAR PRISMS**
**40x40x160 MM**

STANDARDS: EN 196-1 | ASTM C348

**NEEDED ACCESSORIES**

- S337-32** Strain gauge load cell 10 kN capacity.
- S212-05** Loading piston.
- E172-01** Flexure EN device for 40x40x160 mm specimens.  
(available also to ASTM, see p. 428)
- E164N** Software for flexural tests.

**COMPRESSION TEST ON MORTAR SPECIMENS**

(50kN max. load)

STANDARDS: EN 196-1 | EN 1015-11 | ASTM C109, C349

**NEEDED ACCESSORIES**

- S337-34** Strain gauge load cell 50 kN capacity.
- S212-05** Loading piston.
- E170** Compression device on portion of 40x40x160 mm specimens.  
(devices for different specimens described at p. 428)
- E163N** Software for compression tests.

**NEW**
**S205N**  
with load cell

**TENSILE TEST ON MORTAR BRIQUETTES "8" SHAPED**

STANDARDS: ASTM C190, C307 | AASHTO T132

**NEEDED ACCESSORIES**

- S205-05N** Unitronic Compression / Tensile
- S337-32** Tensile/Compression strain load cell 10 kN capacity
- S205-07** Tensile jaws "8" shaped for mortar briquette
- S205-08N** Software for tensile test
- E111** Briquette mould  
(see p. 408)

**E111**

**S205-05N**  
**UNITRONIC COMPRESSION 50 KN | TENSILE 25 KN**

The Unitronic frame S205N is modified and improved to perform also tensile tests with max. capacity of 25 kN.

**S206N****UNITRONIC 200KN****UNIVERSAL ELECTROMECHANICAL FRAME, 200KN CAPACITY**

COMPRESSION / FLEXURE / TENSILE TESTS OF CONSTRUCTION MATERIALS WITH SERVO-CONTROLLED SYSTEM OF LOAD OR DISPLACEMENT/STRAIN.

Unitronic 200kN is the universal and versatile machine fully satisfying the needs of control, research and university laboratories to carry out tests on:

Cement, Roads (Marshall, Duriez, CBR etc.), Steel, Concrete, Wood, Plastic, etc.

The load is applied by a mechanical jack activated by a **brushless closed-loop motor with optical encoder** controlled by a microprocessor.

The two crossheads foresee couplings to fix the different test devices (see accessories). The stress is measured by an electric load cell; the measurement and the displacement control of the crosshead is achieved by the electronic device incorporated into the machine.

Stroke electric end excursion switches of the upper mobile crosshead are foreseen to save the machine from accidental handlings.

**Specifications of the Firmware:** see p. 18

**Specifications of the Frame:** see p. 508

The Unitronic 200kN is **supplied complete with:**

Electric load cell 200kN capacity, crosshead displacement device, upper with seat ball and lower compression platens.

**Are not included:** accessories and software for specific tests that must be ordered separately (see accessories).

**Note:** The machine can be equipped with intermediate load cells to the max. capacity of the machine, to satisfy specific test requirements.

**Power supply:** 230V 1ph 50-60Hz 850W

**Dimensions:** 950x56x2400 mm

**Weight:** 820 kg approx.

**S206N****NEEDED ACCESSORIES****COMPRESSION TEST ON MORTAR SPECIMENS**

STANDARDS: EN 196-1 | EN 1015-11 | ASTM C109, C349

**E170** Compression device on portions of 40x40x160 mm specimens (devices for different specimens described at p. 428)

**E163N** Software for the compression test (p. 18)

**FLEXURAL TEST ON MORTAR PRISMS  
40x40x160 MM**

STANDARDS: EN 196-1 | ASTM C348

**E172-01** Flexure device for 40x40x160mm specimens (available also ASTM, see p. 428)

**S337-32** Strain gauge load cell  
10 kN capacity

**S206-32** Flange/connector of the load  
cell S337-32

**S164N** Software for the flexural  
test (p. 18)

**E172-01****E170****E111****TENSILE TEST ON MORTAR  
BRIQUETTES "8" SHAPED**

STANDARDS: ASTM C190, C307  
AASHTO T132

**S205-07** Tensile jaws "8" shaped for  
mortar briquette

**E111** Briquette mould (p. 408)

**S337-32** Strain gauge load cell  
Tensile/Compression  
10kN capacity

**S206-32** Flange/connector of the load  
cell S337-32

**S205-08N** Software for tensile tests

**S337-32****S205-07**

Additional specific accessories for tests on: Concrete, Asphalt, Soil, Steel, see p. 508

## MACHINES FOR ONLY COMPRESSION TESTS

TO TEST CEMENT AND MORTAR SPECIMENS, BRICKS, ROCKS, REFRACTORIES ETC.

STANDARDS: EN 196-1 | EN 1015-11 | ISO 679 | ASTM C109, C349, C1194 | DIN 1164 | BS 4550 | GOST 26798-1

Designed to perform compression tests on portions of prism 40.1x40x160 mm, cubes side 40, 50, 70, 100 mm and 2"; cores with max. height of 180 mm, by using the suitable compression devices described in next pages (accessories mod. E170 - E171-01)

Equipped with an electric microswitch to stop the piston after the specimen breakage, in order to avoid damages to the compression or flexure device.

### DIAL GAUGES MODELS

- Gauge Ø 200 mm, range 0-300kN, subdiv. 2.5kN

### MAIN FEATURES FOR ALL MODELS

- Two columns high stiffness frame.
- Max. vertical daylight between platens: 185 mm
- Horizontal daylight between columns: 175 mm
- Platens diameter: 153 mm
- Ram travel: 45 mm approx.
- Accuracy: Grade 1 starting from 10% of the scale
- Supplied complete with lower compression platen and coupling piece to easily fix the compression device.
- Power supply (motorized models): 230V 1ph 50Hz 750W
- Weight: 300 - 330 kg



E159D + C127N + E170



E161A + C127N + E170

### COMPRESSION

### LOAD MEASURING SYSTEM

MODEL	Max load kN	Manual	Motorized	Gauge	Digitec mod. C108N (p. 219)	Autotec mod. C098N (p. 219)
<b>E151</b>	300	▼		▼		
<b>E155</b>	300		▼	▼		
<b>E159D</b>	500		▼		▼	
<b>E159-01D</b>	250		▼		▼	
<b>E161A *</b>	250		▼			▼
<b>E161-02A *</b>	500		▼			▼

## MACHINES FOR ONLY COMPRESSION TESTS

TO TEST CEMENT AND MORTAR SPECIMENS, BRICKS, ROCKS, REFRACTORIES ETC.

STANDARDS: EN 196-1 | EN 1015-11 | ISO 679 | ASTM C109, C349, C1194 | DIN 1164 | BS 4550 | GOST 26798-1



**CYBER-PLUS OR SERVO-PLUS EVOLUTION** DIGITAL DISPLAY

**INVERTER**

For a further improvement of energy efficiency and silent operation, (optional device code C099N).  
Technical details, p. 223

**NEW**

**BARCODE**

Scanner for specimen file/identification, (optional device code C099-01).  
Details, p. 223

**NEW**



E159N + C127N + E170



E161N + C127 + E170

COMPRESSION

LOAD MEASURING SYSTEM

MODEL	Max load kN	Motorized	Cyber-Plus Evolution mod. C109N (p. 224)	Servo-Plus Evolution mod. C104N (p. 224)
<b>E159N</b>	500	▼	▼	
<b>E159-01N</b>	250	▼	▼	
<b>E161N *</b>	250	▼		▼
<b>E161-02N *</b>	500	▼		▼

\* Servo-Plus/Autotec models feature fully automatic power pack - electrovalve operated test start (no manual lever).

**ACCESSORIES FOR COMPRESSION MACHINES**

**E170** COMPRESSION DEVICE for portions of prism 40.1x40x160 mm broken in flexure. EN 196, EN/ISO 679, ASTM C349. See p. 428

**E170-01** COMPRESSION DEVICE for portions of 40.1x40x160mm prism broken in flexure. DIN 1164. See p. 428

**E170****E170-01**

**E171** COMPRESSION DEVICE for cubes 50 mm and 2" side. ASTM C109, C1194. See p. 428

**E170-01GO** COMPRESSION DEVICE for portions of 20x20x100 mm prism broken in flexure GOST 26798.1. See p. 428

**E171****E170-01GO**

**E171-01** COMPRESSION DEVICE for cubes 70.7 mm side. BS 4550. See p. 428

**E171-01**

**E161-05** DISTANCE PIECE, 50 mm high

**E161-06** DISTANCE PIECE, 25 mm high

 **Note:** the compression devices do not require any distance piece.

**C127N** GRAPHIC PRINTER on thermo-paper on board

**C127-11** THERMO-PAPER roll for printer (pack of 10 rolls)

**E161-12** SAFETY GUARDS, polycarbonate made, to CE Safety Directive, complete with hinges and lock

**C121-51** STOP SWITCH on safety guards. See p. 317

**C097-05** CLASS 1, starting from 1% of the full range. With a special calibration procedure it is possible to grant Class 1 practically on the full range of the compression machine.

**E161-11** BENCH, to hold the compression frame.

**E161-11**

**C115-01** TWO WAY HYDRAULIC VALVE, to activate a second frame. Technical details: see p. 318

**C115-01**

**C106-10** FLEXURAL DEVICE FOR CONCRETE BEAMS 100x100x400 mm and 150x150x600 mm

**C106-10**

**H009-01** PERSONAL COMPUTER, LCD 22" monitor, keyboard, mouse, cables. The supply of the PC includes the installation of the software

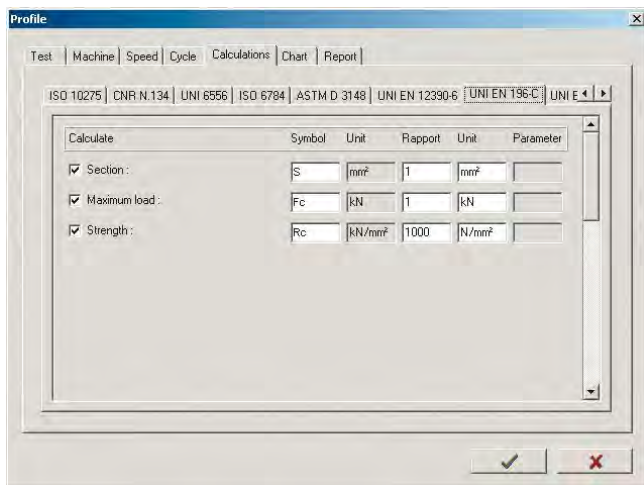
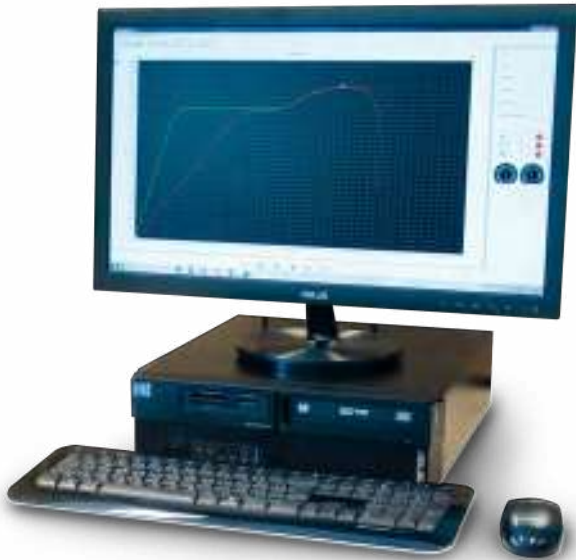

**E163N**

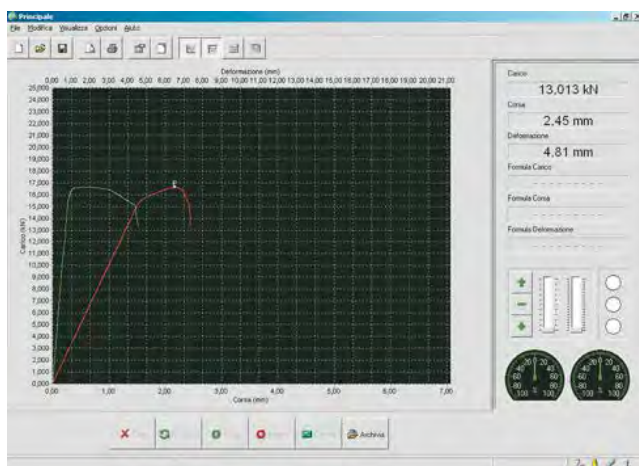

**C123N**

**C104-04** CONSOLE HOUSING THE SERVO-PLUS EVOLUTION  
The pump assembly "lined" with sound proofing material for noise reduction and the digital system are encased to enhance the design and look of the machine. Technical details: see p. 312



**C104-04**

**C099N** INVERTER DEVICE granting a lot of improvements.  
**NEW** Applicable only on Cyber-Plus and Servo-Plus Evolution machines.  
Technical details: see p. 223



**C099N**

SOFTWARE for DIGITEC / AUTOTEC  
or CYBER / SERVO PLUS models

**C123 (N)\*** SOFTWARE **Servonet** for remote control through PC

**E163 (N)\*** SOFTWARE for compression tests

Technical detail: see p. 18

**(N)\*** for Cyber - Servo Plus models.



## COMPRESSION/FLEXURAL TESTING MACHINES WITH DUAL MEASURING RANGE

TO TEST CEMENT AND MORTAR SPECIMENS, BRICKS, ROCKS, REFRACTORIES ETC.

STANDARDS: EN 196-1, EN 13286-41, EN 933-5, EN 1015-11 | ISO 679 | ASTM C109, C348, C349, C1194 | DIN 1164 | BS 4550 | GOST 26798-1

These testing machines foresee a **dual measuring range in the same testing chamber**. The two ranges can be used alternatively and are suitable to perform:

- Flexural tests on cement prisms 40.1x40x160 mm (selecting the low capacity range)
- Compression tests on portions of prism 40.1x40x160 mm broken in flexure, cubes side 40, 50, 70, 100 mm 2", cores with max. height of 180 mm (selecting the nominal range).

The measuring range 0 - 15kN can be also used for compression tests on specimens with expected low strength values.

Equipped with an electric microswitch to stop the piston after the specimen breakage, in order to avoid damages to the compression or flexure device.

### MAIN FEATURES FOR ALL MODELS

- Two columns high stiffness frame.
- Max. vertical daylight between platens: 185 mm
- Horizontal daylight between columns: 175 mm
- Platens diameter: 153 mm
- Ram travel: 45 mm approx.
- Two pressure transducers granting the Class 1 starting from 10% of the scale for both the ranges.
- Supplied complete with lower compression platen and coupling piece to easily fix the compression devices.
- Power supply (motorized models): 230V 1ph 50Hz 750W
- Weight: 310 - 340 kg



E160D + E170



E161-01A + E172-01

#### COMPRESSION | FLEXURAL

#### LOAD MEASURING SYSTEM

MODEL	Dual range kN	Manual	Motorized	Gauge	Digitec mod. C108N (p. 219)	Autotec mod. C098N (p. 219)
<b>E152</b>	300/50	▼		▼		
<b>E156</b>	300/50		▼	▼		
<b>E160D</b>	500/15		▼		▼	
<b>E160-01D</b>	250/15		▼		▼	
<b>E161-01A *</b>	250/15		▼			▼
<b>E161-03A *</b>	500/15		▼			▼

## COMPRESSION/FLEXURAL TESTING MACHINES WITH DUAL MEASURING RANGE TO TEST CEMENT AND MORTAR SPECIMENS, BRICKS, ROCKS, REFRACTORIES ETC.



STANDARDS: EN 196-1, EN 13286-41, EN 933-5, EN 1015-11 | ISO 679 | ASTM C109, C348, C349, C1194 | DIN 1164 | BS 4550 | GOST 26798-1



**CYBER-PLUS OR SERVO-PLUS EVOLUTION** DIGITAL DISPLAY

### INVERTER

For a further improvement of energy efficiency and silent operation, (optional device code C099N).  
Technical details, p. 223



### BARCODE

Scanner for specimen file/identification, (optional device code C099-01).  
Details, p. 223



E160N + E170



E161-01N + C104-04 + C127N + E172-01

### COMPRESSION | FLEXURAL

### LOAD MEASURING SYSTEM

MODEL	Dual range kN	Motorized	Cyber-Plus Evolution mod. C109N (p. 224)	Servo-Plus Evolution mod. C104N (p. 224)
<b>E160N</b>	500/15	▼	▼	
<b>E160-01N</b>	250/15	▼	▼	
<b>E161-01N *</b>	250/15	▼		▼
<b>E161-03N *</b>	500/15	▼		▼

\* Servo-Plus/Autotec models feature fully automatic power pack - electrovalve operated test start (no manual lever).

**ACCESSORIES FOR FLEXURE | COMPRESSION MACHINES**

**E172-01** FLEXURE DEVICE for 40.1x40x160 mm mortar specimens. EN 1015-11, EN 196-1, EN/ISO 679 See p. 428



**E172-01**

**E172-02** FLEXURE DEVICE for 40x40x160 mm mortar specimens. ASTM C348. See p. 428

**E170** COMPRESSION DEVICE for portions of prism 40.1x40x160 mm broken in flexure. EN 196, EN/ISO 679, ASTM C349. See p. 428



**E170**



**E171**

**E171** COMPRESSION DEVICE for cubes 50 mm and 2" side. ASTM C109, C1194. See p. 428

**E171-01** COMPRESSION DEVICE for cubes 70.7 mm side. BS 4550. See p. 428



**E171-01**

 **Note:** other models of flexure and compression devices with accessories are listed at p. 428

**E161-05** DISTANCE PIECE, 50 mm high

**E161-06** DISTANCE PIECE, 25 mm high

 **Note:** the compression devices do not require any distance piece.

**C127N** GRAPHIC PRINTER on thermo-paper on board

**C127-11** THERMO-PAPER roll for printer (pack of 10 rolls)

**E161-12** SAFETY GUARDS, polycarbonate made, to CE Safety Directive, complete with hinges and lock

**C121-51** STOP SWITCH on safety guards. See p. 317

**C097-05** CLASS 1, starting from 1% of the full range. With a special calibration procedure it is possible to grant Class 1 practically on the full range of the compression machine.

**E161-11** BENCH, to hold the compression frame.



**E161-11**

**C115-01** TWO WAY HYDRAULIC VALVE, to activate a second frame. Technical details: see p. 318



**C115-01**

**C106-10** FLEXURAL DEVICE FOR CONCRETE BEAMS 100x100x400 mm and 150x150x600 mm



**C106-10**

**H009-01** PERSONAL COMPUTER, LCD 22" monitor, keyboard, mouse, cables. The supply of the PC includes the installation of the software

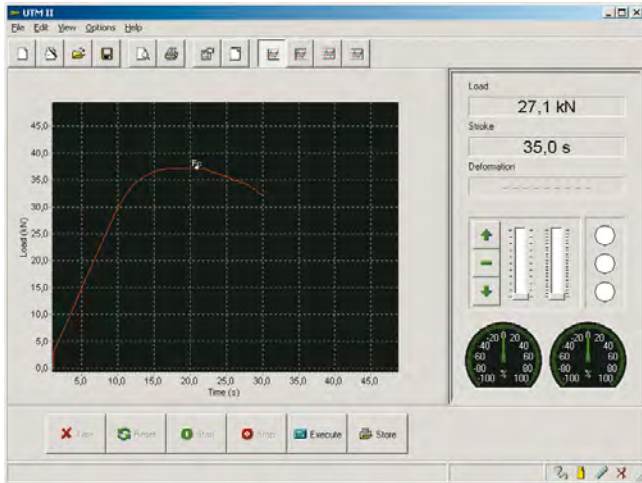

E163

The screenshot shows the Data (190 - 190) software interface. It features a table with columns for #, n°, Name, Symbol, Value, and Unit. Below the table are navigation buttons.

#	n°	Name	Symbol	Value	Unit
1	1	Width:	b	40	mm
1	2	Height:	h	40	mm
1	3	Distance:	l	100	mm
1	4	Maximum load:	Fr	8300	N
1	5	Strength:	Rf	19,453	N/mm <sup>2</sup>

E164

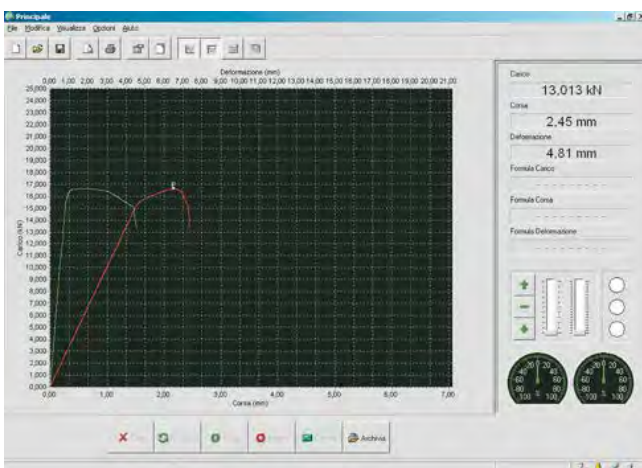

C123N

**C104-04** CONSOLE HOUSING THE SERVO-PLUS EVOLUTION  
The pump assembly "lined" with sound proofing material for noise reduction and the digital system are encased to enhance the design and look of the machine. Technical details: see p. 312



C104-04

**C099N** INVERTER DEVICE granting a lot of improvements.  
**NEW** Applicable only on Cyber-Plus and Servo-Plus Evolution machines.  
Technical details: see p. 223



C099N

SOFTWARE for DIGITEC / AUTOTEC  
or CYBER / SERVO PLUS models

**C123 (N)\*** SOFTWARE **Servonet** for remote control through PC

**E163 (N)\*** SOFTWARE for compression tests

**E164 (N)\*** SOFTWARE for flexural tests

Technical detail: see p. 18

**(N)\*** for Cyber - Servo Plus models.

## COMPRESSION AND FLEXURAL TESTING MACHINE HIGH PERFORMANCE WITH DUAL TESTING CHAMBER AND TWO INDEPENDENT MEASURING RANGES 300 kN AND 15 kN WITH LOAD CELLS

STANDARDS: EN 196-1, EN 13286-41, EN 933-5, EN 1015-11 | ISO 679 | ASTM C109, C348, C349, C1194 | DIN 1164 | BS 4550 | GOST 26798-1

**INVERTER**

For a further improvement of energy efficiency and silent operation, (optional device code C099N).  
Technical details, p. 223



This testing machine of high performance, advanced solutions and top quality components is equipped with two load chambers with two independent measuring ranges. It is suitable to perform:

- Flexural tests on cement prisms 40.1x40x160 mm (with the range 0 - 15 kN)
- Compression tests on portions of prism 40.1x40x160 mm broken in flexure, cubes side 40, 50, 70, 100 mm 2", cores with max. height of 180 mm (with the range 0 - 300 kN) by using the suitable compression devices described in next pages (accessories E170 - E172-02)

The applied load is measured by two strain gage load cells (15kN and 300 kN) at high accuracy.

This solution eliminates the weights of the piston and lower compression platen, packing set frictions etc., granting very high accuracy (max. error within  $\pm 0,5\%$ ). The load chamber 0 - 15 kN permits very accurate tests on specimens having low strength (both in compression and in flexure).

Equipped with an electric microswitch to stop the piston after the specimen breakage, in order to avoid damages to the compression or flexure device.

**MAIN FEATURES FOR ALL MODELS**

- Max. vertical daylight between platens: 189 mm
- Horizontal daylight between columns: 210 mm
- Platens diameter: 165 mm
- Ram travel: 35 mm approx.
- Accuracy: Class 1 starting from 10% of the scale for both the ranges.
- Safety guards to CE Directive, polycarbonate made, with hinges.
- Supplied complete with lower compression platens and coupling pieces to easily fix the compression devices (see accessories).
- Dimensions of the frame: 1300x400xh1500 mm approx.
- Power supply: 230V 1ph 50Hz 750W
- Weight: 400 kg

**Note:** range 0-15 kN can be increased on request up to 25 kN.



Scanner for specimen file/identification, (optional device code C099-01).  
Details, p. 223



E183N + C127N with compression devices

**COMPRESSION / FLEXURAL**
**LOAD MEASURIG SYSTEM**

MODEL	Dual range kN	Cyber-Plus Evolution mod. C109N (p. 224)	Servo-Plus Evolution mod. C104N (p. 224)
<b>E181N</b>	300/15	▼	
<b>E183N</b>	300/15		▼

## ACCESSORIES FOR DUAL CHAMBER MACHINES

- E172-01** FLEXURE DEVICE for 40.1x40x160 mm mortar specimens. EN 1015-11, EN 196-1, EN/ISO 679 See p. 428



**E172-01**

- E172-02** FLEXURE DEVICE for 40x40x160 mm mortar specimens. ASTM C348. See p. 428

- E170** COMPRESSION DEVICE for portions of prism 40.1x 40x160 mm broken in flexure. EN 196, EN/ISO 679, ASTM C349. See p. 428



**E170**

- E171** COMPRESSION DEVICE for cubes 50 mm and 2" side. ASTM C109, C1194. See p. 428



**E171**

- E171-01** COMPRESSION DEVICE for cubes 70.7 mm side. BS 4550. See p. 428



**E171-01**

- Note:** other models of flexure and compression devices with accessories are listed at p. 428

- E161-05** DISTANCE PIECE, 50 mm high

- E161-06** DISTANCE PIECE, 25 mm high

- Note:** the compression devices do not require any distance piece.

- C127N** GRAPHIC PRINTER on thermo-paper on board.

- C127-11** THERMO-PAPER roll for printer (pack of 10 rolls)

- E183-10** SAFETY GUARDS complete with stop switch.

- C097-05** CLASS 1, starting from 1% of the full range. With a special calibration procedure it is possible to grant Class 1 practically on the full range of the machine.

- H009-01** PERSONAL COMPUTER, LCD 22" monitor, keyboard, mouse, cables. The supply of the PC includes the installation of the software

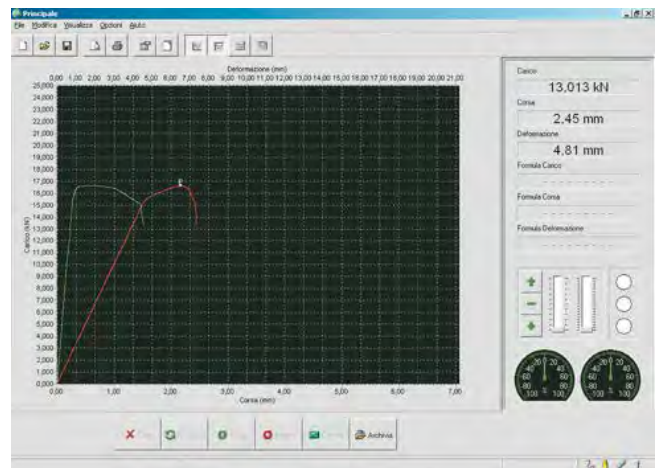

**C123N**

- C099N** INVERTER DEVICE granting a lot of improvements. **NEW** Applicable only on Cyber-Plus and Servo-Plus Evolution machines. Technical details: see p. 223



**C099N**

## SOFTWARE

- C123N** SOFTWARE **Servonet** for remote control through PC only for Servo-Plus

- E163N** SOFTWARE for compression tests

- E164N** SOFTWARE for flexural tests

Technical detail: see p. 18

**COMPRESSION DEVICES**

To be positioned between the compression platens of the machine; they fit perfectly without removing anything and without adding any distance piece.

**Dimensions:** 153x153x185 mm

**MODELS**
**E170  
COMPRESSION DEVICE FOR PORTIONS OF  
40.1x40x160 MM PRISM BROKEN IN FLEXURE**

STANDARDS: EN 196-1 | ASTM C349 | ISO 679

The compression platens have hardness 60 HRC and upper platen is seat ball assembled. The centering plug is distant 10 mm from the compression platen, as requested by the EN 196-1 Specification. Cadmium plated for rust protection.

**Weight:** 12 kg approx.

**E170****ACCESSORY FOR MOD. E170**
**E170-11 CENTERING PLUG  
STANDARD: EN 1015-11**

Fixed on the E170 device in replacement of the standard centering plug, it modifies the distance from the compression platen to 16 mm, as requested by EN 1015-11 Specification.

**E170-01  
COMPRESSION DEVICE FOR PORTIONS OF  
40.1x40x160 MM PRISM BROKEN IN FLEXURE**

STANDARD: DIN 1164

Identical to mod. E170 but with compression platens having 40x62.5 mm size, as requested by DIN Standards.

**Weight:** 12 kg approx.

**E170-01**
**E170-01G0  
COMPRESSION DEVICE FOR  
PORTIONS OF 20x20x100 MM PRISM BROKEN IN  
FLEXURE**

STANDARD: GOST 26798.1

Identical to mod. E170 but with compression platens as requested by Russian Standard.

**E172-01G0****E170-01G0**
**E171  
COMPRESSION DEVICE FOR CUBE 50 MM AND  
2" SIDE**

STANDARD: ASTM C109, C1194

Platens diameter: 72 mm and upper platen is seat ball assembled. This device can be used also to test cores max. 50 mm height.

**Dimensions:** 153x153x185 mm

**Weight:** 12 kg approx.

**E171**
**E171-01  
COMPRESSION DEVICE FOR CUBE 70.7 MM SIDE**

STANDARD: BS 4550

It can be used also to test cores max. 70 mm height

**Dimensions:** 150x130x185

**Weight:** 9 kg approx.

**E171-01**
**E172-01  
FLEXURE DEVICE FOR 40.1x40x160 MM PRISMS**

STANDARDS: EN 196-1 | EN 1015-11 | DIN 1164 | ISO 679

Upper bearer is seat ball assembled.

The distance between lower bearers is 100 mm and one of them has a spherical seat. Cadmium plated for rust protection.

**Dimensions:** 160x153x185 mm

**Weight:** 11 kg approx.

**E172-01**
**E172-01G0  
FLEXURE DEVICE FOR 20x20x100 MM PRISMS**

STANDARD: GOST 26798.1

Identical to mod. E172-01 but with bearers as requested by Russian Standard.

**E172-02  
FLEXURE DEVICE FOR 40x40x160 MM PRISMS**

STANDARD: ASTM C348

Identical to mod. E172-01 but lower bearers have distance of 119 mm as requested by ASTM Standard.

**Weight:** 11 kg approx.

## COMBINED TWO FRAMES GROUP

UPGRADING OPTION:

- COMPRESSION AND FLEXURAL TEST ON MORTAR SPECIMENS
- COMPRESSION TESTS ON CONCRETE CUBE, CYLINDER AND BLOCKS SPECIMENS, BY CHOOSING THE STANDARD COMPRESSION MACHINE AMONG OUR DIFFERENT AVAILABLE MODELS FROM 1300 kN TO 5000 kN CAPACITY (see section Concrete from p. 230...280)

The composition of the combined group is obtained by:

### C092-05 COMPRESSION FRAME ON MORTAR SPECIMENS

250 kN or 500 kN capacity, (mod. E159D, E159-01D, E159N, E159-01N, E161A, E161-02A, E161N, E161-02N; technical details and specific accessories at p. 418...421) complete with pressure transducer used in conjunction with a concrete digital compression machine (Digitec, Autotec, Cyber-Plus / Servo-Plus Evolution, see p. 230...280).



C055 example

C092-05

### C092-06 COMPRESSION/FLEXURAL FRAME ON MORTAR SPECIMENS, DUAL RANGE:

0-250 kN (or 500 kN) for compression tests 0-15 kN for flexure tests (mod. E160N, E160-01N, E161-01N, E161-03N; technical details and specific accessories at p. 422...425) complete with two pressure transducers used in conjunction with a concrete digital compression machine (Cyber-Plus / Servo-Plus Evolution model only, see p. 230...280).



C056 example

C092-06

### C092-07 DUAL TESTING CHAMBER FRAME

(E181N, E183N technical details at p. 426) 300 kN and 15 kN, complete with load cells, used in conjunction with a concrete digital compression machine / Cyber and Servo-Plus Evolution models only. See p. 230...280



C055 example

C092-07

In addition to the proposed groups, it is possible to compose many other alternative testing groups, with digital display measuring system; like for ex:

- Group formed by one concrete flexural frame and one mortar compression frame.



Group example



**E190N****DETERMINATION OF MODULUS OF ELASTICITY IN COMPRESSION OF PRODUCTS AND SYSTEMS FOR THE PROTECTION AND REPAIR OF CONCRETE STRUCTURES (MORTARS).**

AUTOMATIC WITH PACE RATE CONTROL ALSO WHEN RELEASING THE LOAD

STANDARD: EN 13412



It can be used with a MATEST testing machine to be selected among the Servo-Plus Evolution models (ref. C104N, see p. 224).

The appliance includes:

#### ■ HYDRAULIC SYSTEM

It is an hydraulic installation and has a high performance valve directly controlled by the digital unit that grants the automatic control of the pace rate increasing the load, keeps a certain load and than controls the pace rate decreasing the load.

The setting of the pace rate is made by a very sensitive valve controlled by a step by step motor and it allows a micrometric action on the pace rate granting excellent results.

A laser position detector allows a rapid positioning of the piston. This grants a touching sensitivity of test starting of about 0.1 per thousand of the maximum capacity.

#### ■ ELECTRONIC MEASURING SYSTEM

The high performance control and data processing unit controlled by a 32 bit microprocessor, can manage up to 8 high resolution channels for the control of load cells or transducers with strain gages bridge.

The unit contains two Analogical/Digital last generation converters with 24 bits resolution. The system processes the signals coming from the load cells and from the extensometers giving all the results required for a further processing following the most updated International Standards for this application.

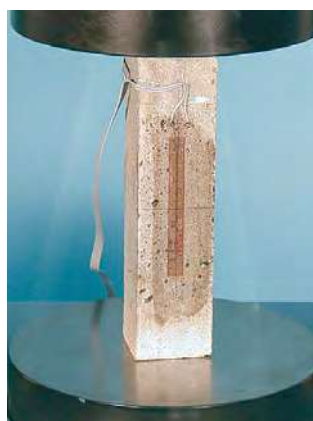

C125-13



C134

#### ■ DATA ACQUISITION AND PROCESSING SOFTWARE UTM2 LICENSE FOR ELASTIC MODULUS TO EN 13412

The software has been developed on the working line of the already known software UTM-2 (windows menu). It contains the profiles of the main Standards used, but the user can modify as he likes and personalise the test profile, that will be effected in a completely automatic way by the testing machine.

The user can introduce a list of dates concerning the specimen that will be tested and the kind of test that he wants to make: shape of the specimen, dimensions, age of the specimen, average expected breaking value, etc... The appliance allows verifying the proper reading of the extensometers and, if everything is within the expected tolerances, it manages the average deformation value read by the transducers and processed by the digital unit, than it transmits by means of the serial communication port RJ (Network Connection) to a Personal Computer, that can be already by the end user or supplied separately (not included with the Software), all the dates of the test. These dates will be processed by the software and transformed in a graph load/deformation and load/time, following the International Standards.

The software gives the possibility to print on a standard printer a test certificate reporting all the dates concerning the test and the specimen and the graph of the test. The Software includes the license "Servonet" mod. C123N while the extensometers (two models are proposed: A and B) are not included in the standard supply, and must be ordered separately (see accessories).

**Note:** The Elastic Modulus on Mortars mod. E190N can be used together with:

A) EXTENSOMETERS (STRAIN GAGES), SINGLE USE, ELECTRIC, available in different sizes, mod. C125-10 to C125-13 (see accessories).

or:

B) EXTENSOMETERS /COMPRESSOMETERS, electronic, universal, mechanical frame, mod. C134 (see accessories)

AS AN ALTERNATIVE:

B) **C134**  
EXTENSOMETER / COMPRESSOMETER, ELECTRONIC, UNIVERSAL, MECHANICAL FRAME.  
It can be used only with samples having minimum height of 130 mm  
Technical details: see p. 286

**C134-10**  
TEMPLATE, to regulate and calibrate the base length of the C134 extensometer.



**C134**

## ACCESSORIES

A) EXTENSOMETERS (STRAIN GAGES), SINGLE USE, ELECTRIC  
Pack of 10 pieces

Available models:

- C125-10** Base length 10 mm
- C125-11** Base length 20 mm
- C125-12** Base length 30 mm
- C125-13** Base length 60 mm
- C125-14** Base length 120 mm

### C125-15

KIT for the application of single use extensometers composed by: glue, welder, solder, cleaning liquid, accessories, the whole in carrying case.

### C125-09

INTERFACE MODULE, **needed accessory** to connect up to 4 electric single use extensometers. This module allows also the automatic calibration of the zero and of the measuring range after a special thermal compensation. This grants a five times better accuracy than the one requested by the Standards.



**C125-09**

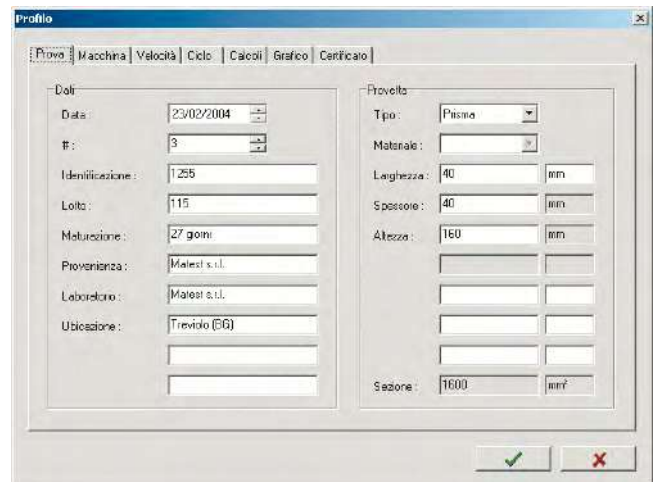

Personalisation of the test certificate.

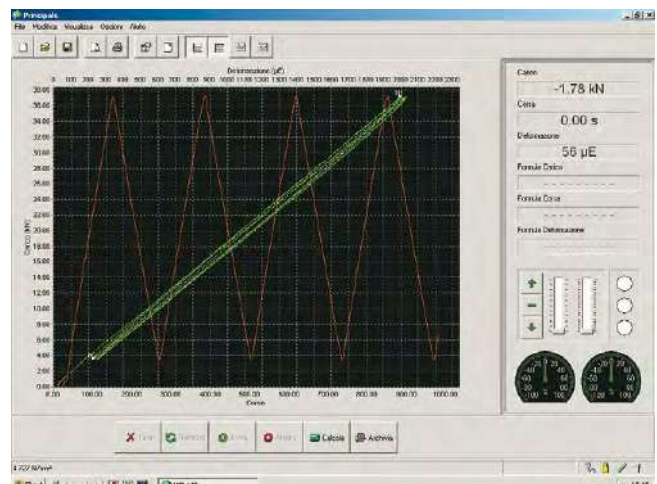

Screen during a test and marker indicating any change.



**MATEST**  
INNOVATIVE. GLOBAL. MANUFACTURER.

# SECTION H

## STEEL



In this section Matest proposes a wide range of universal electromechanical and hydraulic machines to perform tensile, elongation, flexural, bending, resilience tests on metallic materials, with the possibility to extend these test applications on plastics, rubber, composed materials, wires, ropes, paper, textiles etc.

This range of machines satisfies both control tests on steel bars for reinforced concrete, and quality tests in the iron metallurgy, metals, plastics etc.



## UNIVERSAL AUTOMATIC TENSILE TESTING MACHINES: 600 kN, 1000 kN, 1500 kN, 2000 kN CAPACITY

STANDARDS: EN ISO 6892-1, EN 7500-1 | EN 10002, EN 10080, EN 50081-1, EN 15630-1, EN 15630-3 | ASTM A370, ASTM E8  
 UNI 7676 (Wire Strands)



The machine is designed to meet requirements of works, laboratories and universities for quality control and research purposes. This system is suitable to test metallic round and flat rebars, to determine tension, compression, bending shear strength and to determine compression and flexure strength on concrete.



### LOAD FRAME FEATURES

- Models: 600 kN, 1000 kN, 1500 kN, 2000 kN Capacity. Other load capacities (700 kN and 1200 kN) available on request. (see next pages)
- Hydraulic servo-controlled system regulating the load rate
- Four thick columns and two lead screws grant high structural stiffness
- Two different work spaces, the upper one for tension and the lower one for compression, bending and shearing, for a comfortable test execution
- High precision load cell, class 1 according to ISO 376 standard, grants accurate force measurement
- Hydraulic jaws, for stronger clamping of specimens
- Possibility to fit accessories for tensile tests on nut bolts, headed and shouldered specimens, wire ropes
- Integrated displacement photoelectric encoder
- Movable lower crosshead with button panel for an easy machine operation and specimens positioning
- Compression platens included for an easy machine calibration
- Machine CLASS: 1

Load frame H001BS (1000 kN) is specially designed (improved tension space and power pack) to also perform tensile tests on wire strands (UNI 7676).

A **second frame** (accessory) can be easily connected to perform a compression test on concrete specimens, including configurations for Elastic Modulus and Poisson ratio determination.

The most common combination is with C092-09, 2000 kN compression frame useful for testing cubes up to 150 mm side and cylinders up to 160x320 mm also with **capping retainers** (ASTM C1231).

### HYDRAULIC JAWS CLOSURE NEEDED FOR SAFETY REASONS



H001BS with accessories

## FIRMWARE

- Fully automatic test cycle with closed-loop digital feedback
- Electronic control unit "Servo-plus Evolution" with Touch-Screen colour display, that runs like a standard PC based on Windows operating system for management and analysis of data, test results, graphs.
- The Touch-Screen icon interface allows an easy set-up of parameters and an immediate test execution.
- The machine can also be connected to a PC for a remote test execution through suitable Software.
- Direct connection to Intranet (connection to a LAN network) and Internet to establish a remote communication and receive an immediate diagnostic analysis from Matest technicians, or for any software updates.
- Unlimited memory storage with: 2 USB ports, 1 SD card slot, 1 RS232/485 serial port.
- Possibility to select different languages.
- Hardware technical details: see p. 18

The machine is supplied complete with loading frame, control unit, compression platens and hydraulic power pack for jaws closing, while PC, software, grips, printer and extensometers (see next pages) **are optional and must be ordered separately** according to the user needs.

## DIFFERENT FRAMES, DIFFERENT NEEDS



**CONTROL SYSTEM**

Button panel, to control the lower crosshead movement for specimen positioning before testing.

**HYDRAULIC JAWS POWER PACKS**

Standard model, low clamping pressure only (3 buttons)

Strands model, possibility to switch between high (strands) and low (round and flat rebars) clamping pressure (4 buttons)

**TECHNICAL SPECIFICATIONS**

MODEL	H001A	H001B	H001BS*	H001C	H001D
<b>Load capacity (kN)</b> both tension and compression	<b>600</b>	<b>1000</b>	<b>1000</b>	<b>1500</b>	<b>2000</b>
Load accuracy (%)	± 1	± 1	± 1	± 1	± 1
Test speed (mm/min):					
Max	85	35	35	17	17
Min	0.5	0.5	0.5	0.5	0.5
Deformation accuracy (%)	± 1	± 1	± 1	± 1	± 1
Max crosshead moving speed (mm/min)	200	200	200	200	200
Piston stroke (mm)	250	250	250	250	250
Horizontal columns distance	480	580	590	700	840
Max tension space (mm)	750	750	1000	1000	1000
Columns diameter	75	80	100	110	110
Length of the grips for standard samples	90	110	110	160	160
Length of the insert for strands and special samples			225		250
Max compression space (mm)	590	570	680	750	780
Dimension of platens** (mm)	Ø128x30	Ø148x40	Ø148x40	Ø200x60	Ø200x60
Span of bending attachment (mm)	30-500	50-500	50-500	50-500	50-720
Roller length (mm)	120	160	160	160	160
Roller diameter (mm)	30	50	50	50	50
Bending depth (mm)	100	180	180	180	180
Load frame dimensions (mm)					
Height (including piston stroke)	2450	2665	3115	3500	3500
Width	770	900	980	1120	1340
Depth	600	650	670	850	1000
Frame weight (kg)	2700	3100	3900	5000	9000
Power supply	380V, 3ph, 50-60Hz				
Absorbed power (kW)	3.5	3.5	3.5	3.5	6.2

\* Wire Strands can be tested with this model only. Other models for wire strands testing are available on request.

\*\* Compression platens are already included in the supplied machine

## ACCESSORIES FOR

MACHINE MODEL (load capacity*)	H001A 600 kN	H001B 1000 kN	H001BS 1000 kN	H001C 1500 kN	H001D 2000 kN
Grips for round specimens $\varnothing$ 6...14 mm	H001A-11	H001B-11	H001B-11		
Grips for round specimens $\varnothing$ 13...27 mm	H001A-12				
Grips for round specimens $\varnothing$ 28...40 mm	H001A-13				
Grips for round specimens $\varnothing$ 9...21 mm		H001B-12	H001B-12		
Grips for round specimens $\varnothing$ 22...41 mm		H001B-13	H001B-13		
Grips for round specimens $\varnothing$ 42...60 mm		H001B-14	H001B-14		
Grips for round specimens $\varnothing$ 8...20 mm					H001D-11
Grips for round specimens $\varnothing$ 16...32 mm					H001D-12
Grips for round specimens $\varnothing$ 33...47 mm					H001D-13
Grips for round specimens $\varnothing$ 48...61 mm					H001D-14
Grips for round specimens $\varnothing$ 62...80 mm					H001D-15
Grips for round specimens $\varnothing$ 13...31 mm				H001C-11	
Grips for round specimens $\varnothing$ 32...60 mm				H001C-12	
Grips for flat specimens 0...16 mm	H001A-21				
Grips for flat specimens 17...30 mm	H001A-22				
Grips for flat specimens 0...30 mm		H001B-21	H001B-21		
Grips for flat specimens 10...41 mm		H001B-22	H001B-22	H001C-21	H001D-21
Grips for flat specimens 42...70 mm				H001C-22	H001D-22
Grips for strands $\varnothing$ 9.5 mm			H001BS-31		
Grips for strands $\varnothing$ 12.7 mm			H001BS-32		
Grips for strands $\varnothing$ 15.2 mm			H001BS-33		
Aluminium and carborundum insert, 4 pieces			H001-30		
Bending accessory (ISO 5173)	H001A-40	H001B-40	H001B-40	H001C-40	H001D-40
Bend-Rebend device (ISO 15630-1 and ISO 15630-3) Mandrels (Needed Accessories) When ordering specify diameter and strength.	H001B-41 H001B-42	H001B-41 H001B-42	H001B-41 H001B-42	H001D-41 H001D-42	H001D-41 H001D-42
Shearing accessory for specimens $\varnothing$ 10 mm	H001-45	H001-45	H001-45	H001-45	H001-45
Accessories for threaded and shouldered head samples from M3 to M39 (or more on request), composed by: 					
Grips	H001B-43	H001B-43	H001B-43	H001D-43	H001D-43
Tensile bowl and ring. When ordering specify diameter and thread type.	H001B-44	H001B-44	H001B-44	H001D-44	H001D-44
OR tensile bowl and ring with self-alignment. When ordering specify diameter and thread type.	H001B-45	H001B-45	H001B-45	H001D-45	H001D-45

\* Models with 700 kN and 1200 kN capacities available on request.





H001BS with accessories

C092-09

## ADDITIONAL ACCESSORIES

### C092-09

COMPRESSION FRAME, 2000 kN capacity, connected to the same control unit. Vertical daylight: 376 mm with a distance piece of 40 mm high. Useful to test concrete cubes up to 150 mm side and cylinders up to 160x320 mm also with capping retainers. Technical details: see p. 238

#### Note:

It is possible to connect different types of compression frames and other frames (up to 2) for many other tests: flexure, splitting, cement, etc. Ask our technicians for more details.

#### Note:

Electronic extensometers and software are listed at p. 439, 449.



Grips for flat specimens

### H009-01

PERSONAL COMPUTER for remote test execution with a pre-installed software. Complete with LCD, monitor 22", keyboard, mouse, connection cable.

#### Note:

The PC is recommended, but not necessary: the machine can in any case perform tests without any external PC.



Grips for round specimens

### H009N

SOFTWARE for tensile tests on steel (Load/Deformation, graphic, test certificate etc.)

## H014 ELECTRONIC EXTENSOMETER

Measuring base 50 mm, Deformation range +1 mm / -0.2 mm  
Maximum percent measurable deformation: +2%  
It gives the possibility to take the longitudinal deformations of the specimen during the tensile test. A graph load/deformation is obtained and from this graph the coefficient of elasticity together with the loads RP0.1 - RP0.2 - Rt1 can be identified even on materials that are not presenting a yield point that can be clearly identified. The appliance is delivered complete with connection cables.

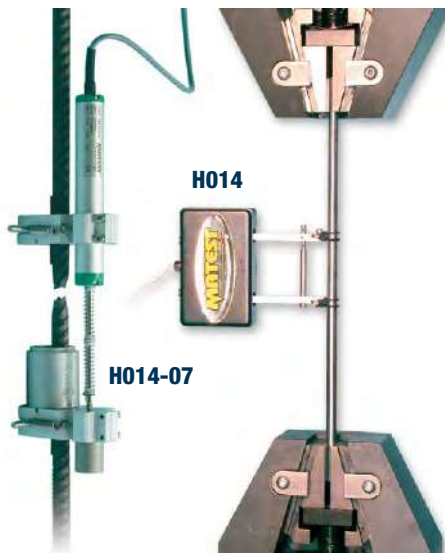

## ELECTRONIC EXTENSOMETER FOR TENSILE DEFORMATION STRENGTH TESTS UNTIL BREAKAGE

### MODELS

- H014-06** Extensometer for round specimens from 4.5 to 11 mm diameter. Transducer stroke: 25 mm
- H014-07** Extensometer for round specimens from 10 to 19 mm diameter. Transducer stroke: 50 mm
- H014-08** Extensometer for round specimens from 18 to 25 mm diameter. Transducer stroke: 50 mm
- H014-09** Extensometer for round specimens from 26 to 36 mm diameter. Transducer stroke: 50 mm
- H014-10** Extensometer for flat specimens, width max. 25 mm; thickness max. 10 mm. Transducer stroke: 50 mm  
Measuring base: 25 – 50 – 60 – 70 mm
- H014-11** Extensometer for round specimens from 35 to 49 mm diameter. Transducer stroke: 50 mm
- H014-12** Extensometer for round specimens from 48 to 61 mm diameter. Transducer stroke: 50 mm

## H003-18 WIRE STRANDS EXTENSOMETER

STANDARD: UNI 7676

The instrument is directly applied on the sample through two coaxial telescopic hardened tubes by measuring the deformation/elongation of the strand up to failure.

Supplied complete with electronic precision transducer 50 mm stroke by 0,005 mm sensitivity.

Measuring base: 600 mm

The H003-18 extensometer can be utilized only with the machine mod. H001BS

Dimensions: 105 x 630 mm

Weight: 1000 g

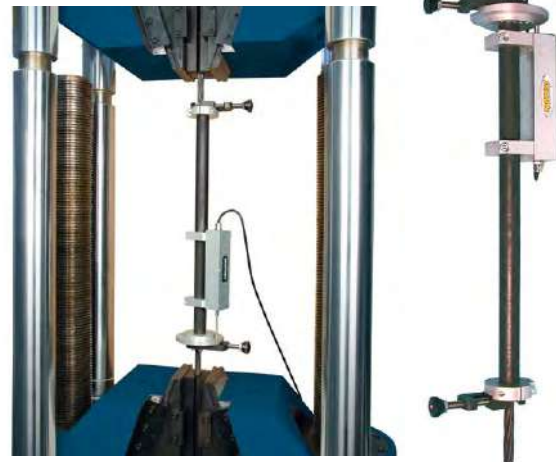

**H003-18** Detail of the wire strands extensometer

Alternative compression platens, complete with upper seat ball.



**H001C-50** Detail of the standard compression platens

MACHINE MODEL	Model	Ø mm	Max specimen dimensions
H001A	H001A-50	165X30	Cubes up to 100 mm side and cylinders up to Ø 110x220 mm
H001B and H001BS	H001B-50	216X30	Cubes up to 150 mm side and cylinders up to Ø 160x320 mm
H001C and H001D	H001C-50	287x51	Cubes up to 200 mm side and cylinders up to Ø 160x320 mm

## H003N UNIVERSAL HYDRAULIC SERVO-CONTROLLED MACHINE 600 KN CAPACITY TO PERFORM STATIC TENSILE TESTS ON METALLIC MATERIALS.



STANDARDS: EN 10002, EN 10080, EN 15630-1, EN 15630-3 | EN ISO 6892-1, 7500-1 | ASTM A370, ASTM E8

It basically consists of:

- Strong loading frame with a reading cell built into the piston
- Hydraulic Servo-Plus Evolution Touch-Screen system (technical details: see p. 224; firmware details: see p. 18), for the data acquisition, control and processing. The whole is built in a console.

The frame is designed to carry out tensile tests using the grips placed in the clamping heads. In the upper part, between the head and traverse, it is possible to carry out flexion, compression, bending, hardness, dishing tests, according to the International Standards by using the suitable (see accessories) devices. The hydraulic servocontrolled unit regulates the load rate by the Computer. An emergency device stops the machine in any moment as per the International Safety Standards.

A control pedal situated on the frame governs the movement of the lower tensile head (excursion 0 to 580 mm with electric end of stroke switches) for an easier positioning of the specimen according to its length. The machine is supplied complete with loading frame, control console, while the software (mod. H009), extensometers (mod. H014 to H014-10) grips and the printer **are options and must be ordered separately** according to the needs of the user.

### TECHNICAL SPECIFICATIONS

Capacity	600 kN
Max. crosshead stroke	200 mm
Max. distance between the jaws	465 mm
Width flexion joke	190 mm
Max. flexion knives distance	1000 mm
Compression plates light	235 mm
Load reading	Sensing by loading cell. Resolution 0.01% U.V.
Accuracy	Class 1 EN 10002-2 Only reading scale 1:1-1:20 U.V.
Stroke reading	Sensing by linear transducer Resolution 0,01 mm
Deformation reading	Sensing by electronic extensometer (accessory) Resolution 0.001 mm
Accuracy	Class B 2 (B 1 for base up to 50 mm) ASTM E83
Needed height	4050 mm
Frame weight	2600 kg approx.
Rack dimensions	610x630x1600 mm
Power supply	230V 1ph 50Hz 2kW



H003N with accessories

### H003-99 KIT FOR MACHINE DELIVERY

The kit is composed by different mechanical devices to flatwise the machine allowing its transport.

The amount of this kit is fully reimbursed to the customer if the kit is returned to Matest after the delivery.

## ACCESSORIES FOR H003N

ROUND AND FLAT GRIPS. One set consists of two double pairs that must be placed into the upper and lower tensile heads.

**H003-03** Set of Grips for Flat specimens from 2 to 18 mm and Round specimens  $\varnothing$  5...12 mm

**H003-04** Set of Grips for Flat specimens 18...36 mm

**H003-07** Set of Grips for Round specimens from  $\varnothing$  12...24 mm

**H003-08** Set of Grips for Round specimens from  $\varnothing$  25...40 mm

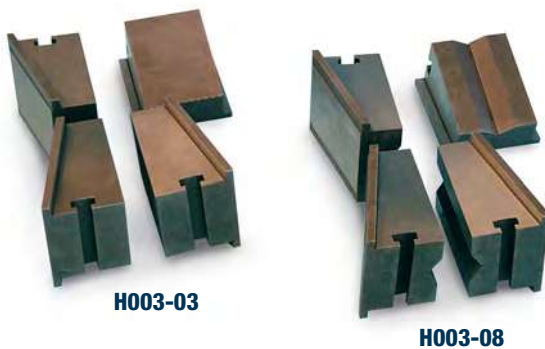

**Note:** The software (H009N) is listed at p. 449  
The extensometers (H014 to H014-10) are listed at p. 445

## ACCESSORIES FOR TESTS ON METALS

### H003-11 FLEXURE TEST

STANDARD: UNI 559

The equipment is composed by a couple of lower bearers with adjustable supports and an upper blade.

Maximum load: 200 kN

Maximum distance between the lower bearers: 1000 mm

Width of the bearers: 120 mm

Diameter of the bearers: 50 mm

**Weight:** 70 kg approx.



### H003-12 BENDING TEST

STANDARDS: UNI 564 | ASTM E290

The equipment is composed by a couple of lower bearers with adjustable supports and an upper blade.

Maximum load: 200 kN

Maximum distance between the lower bearers: 1000 mm

Width of the bearers: 120 mm

Diameter of the bearers: 50 mm

**Weight:** 70 kg approx.

**Note:** bearers with different diameters are available on request.

### H003-13 COMPRESSION TEST

STANDARD: UNI 558

The equipment is composed by an upper plate with seat ball assembly and by a lower plate.

Maximum load: 600 kN

Diameter of the compression plates: 90 mm

**Weight:** 25 kg approx.

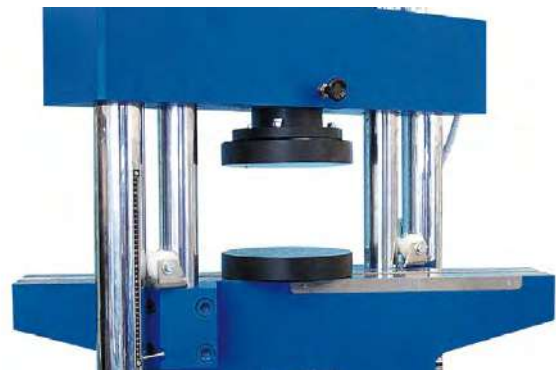

### H003-14 TEST ON ELECTRO WELDED WIRE NETS

Device for the seizing of electro welded wire nets; this equipment must be used with the grips for flat specimens.

**Weight:** 5 kg approx.

## ACCESSORIES FOR TESTS ON CONCRETE

### H003-21 COMPRESSION TEST on concrete cube specimens, max 150 mm side.

The appliance is composed of:

An upper compression plate 287 mm diameter complete with seat ball assembly. A lower compression plate 287 mm diameter

Maximum distance between the compression plates: 185 mm.

**Weight:** 60 kg approx.

### H003-22 FLEXURE TEST on concrete beams with dimensions 100x100x400/500 mm and 150x150x600/750 mm

STANDARDS: EN 12390-5 / ASTM C78, C293

Composed by two lower and one upper bearers

Maximum load: 200 kN

Maximum distance between the lower bearers: 1000 mm.

Width of the bearers: 160 mm.

**Weight:** 40 kg approx.

## SERVO-CONTROLLED ELECTROMECHANICAL UNIVERSAL TESTING MACHINE

STANDARDS: EN 12390-4 | EN ISO 6892, 7500-1 | ASTM E4

The machine is suitable to make tensile and elongation tests in Laboratories for Quality Control and research on different materials, such as Metals, Plastics, Composed Materials, Wires, Ropes, Paper, Textiles etc.

For each testing purpose, suitable machine range, seizing grips and accessories must be selected.



### MAIN FEATURES

- Strong base containing the transmission components and the Hardware control instruments.
- Two big diameter and high resistance steel columns with ground hard chrome surfacing granting a high lateral rigidity.
- Possibility to execute tests in both directions.
- Two re-circulating spheres screws with pre-loaded female screws that grant no clearance to the cross-bar movement.
- Big section cross-bar granting high stiffness (see UNI ISO 5893 Standards).
- Sintered bushes with low friction coefficient cross-bar movement.

The Load Cell is made in stainless steel and reads both tensile and compression loads with a very high precision.

Accuracy class	1
Repeatability error	$\leq \pm 0.145\%$
Interpolation error	$\leq \pm 0.090\%$
Error on zero	$\leq \pm 0.03\%$ F.S.
Reversibility error	$\leq \pm 0.240\%$
Linearity error	$\leq \pm 0.005\%$ F.S.
Hysteresis	$\leq \pm 0.05\%$ F.S.
Maximum overload capacity	150%

In order to follow the specific needs of each single application, different load cells with different capacities within the nominal capacity of the machine can be installed on the frame.

Different connections for the installation of the seizing devices are on the mobile cross-bar and on the base (see accessories at following pages).

The machine is delivered with different safety devices limiting the maximum travel of the cross-bar. There is also an adjustable device that allows setting a personalized upper and lower travel limit following the used appliances.



H007N + H014-07 + H009N + H007-11 + H007-21 + H009-01

**Firmware:**

- Electronic control unit “Cyber-plus Evolution” **with Touch-Screen colour display**, that runs like a standard PC based on Windows operating system for the management and analysis of the data, test results, graphs.
- The Touch-Screen icon interface allows an easy set up of the parameters and immediate execution of the test.
- The machine can be connected to a PC for remote test execution through suitable Software; the machine can in any case perform the tests without any external PC, because of the “Cyber-Plus” grants performances like a PC.
- Direct connection to Intranet (connection to a LAN network) and Internet to establish a remote communication and receive an immediate diagnostic analysis from Matest technicians, or for updates of the software.
- Unlimited memory storage with: 2 USB ports, 1 SD card slot, RS232/485 serial port.
- Possibility to select different languages.
- Hardware technical details: see p. 18

**H005N**

The frames protecting the columns and the screws are made of painted steel sheets, the internal sides are closed with anti-dust bellows and all the outside and internal parts are properly treated against the corrosion.

Following equipments are not delivered with the machine and have consequently to be ordered separately (see following pages):

- Personal computer model H009-01
- Standard UTM 2 software model H009N
- Special personalised programs (following the customer demand).
- Accessories for the seizing of the specimens.
- Printer model C128
- Extensometers model H014 to H014-10 (p. 445)
- Other accessories

- The voltage must not have peaks of tension, over-tensions and transitory over-currents or drops of voltage higher than 10% of the nominal voltage.

- Working temperature from +5 °C up to +45 °C.

- Humidity range from +10% up to +90%, without condensation.

**AVAILABLE MODELS**

MODEL	H004N	H005N	H006N	H007N	H008N
LOAD					
CAPACITY kN	10	50	100	200	600
TEST SPEED mm/min					
Minimum	0.01	0.01	0.01	0.01	0.01
Maximum	500	500	500	480	300
POSITIONING SPEED mm/min.	500	500	500	480	250
CROSS BAR TRAVEL (* mm)	1130	1130	1180	1150	1500
OPENING OF THE TESTING CHAMBER					
Vertical mm (**)	1253	1251	1310	1280	1510
Horizontal mm	421	421	600	600	713
MAXIMUM DISTANCE BETWEEN THE TENSILE HEADS mm (***)	630	612	510	480	550
DIMENSIONS mm					
height	1708	1845	2340	2340	3000
width	550	810	1370	1370	1465
depth	683	670	700	700	930
WEIGHT kg	250	370	1000	1150	2600
POWER SUPPLY	230V 1ph 50Hz	230V 1ph 50Hz	400V 3ph 50Hz	400V 3ph 50Hz	400V 3ph 50Hz
ABSORBED POWER W	1000	1200	2000	3000	3000

(\*) The cross bar travel is referred to the distance between the upper surface of the base and the lower surface of the cross bar and it doesn't include the load cell, the seizing devices, the different equipments etc.

(\*\*) The vertical opening of the testing chamber is the distance between the upper surface of the base and the lower surface of the crossbar, without load cells, seizing devices and other devices.

(\*\*\*) The maximum distance between the tensile heads is the distance between the grips when the crossbar is at its upper dead point (load cell is installed). Practically it is the free length of the specimen between the tensile heads.

**ACCESSORIES FOR:**

MACHINE CODE CAPACITY	H004N 10 kN	H005N 50 kN	H006N 100 kN	H007N 200 kN	H008N 600 kN
Couplings for installation of the tensile heads or the devices	<b>H005-40</b>	<b>H005-40</b>	<b>H007-40</b>	<b>H007-40</b>	
Tensile heads	<b>H005-11</b>	<b>H005-11</b>	<b>H007-11</b>	<b>H007-11</b>	<b>H008-11</b>
Flat seizing grips for specimens as follows: Flat spec. thickness 0...10 mm Width max 25 mm Round specimens Ø 3...5 mm	<b>H005-21</b>	<b>H005-21</b>			
Flat spec. thickness 0...10 mm Width max 50 mm Round specimens Ø 3...10 mm				<b>H007-21</b>	
Flat spec. thickness 11...22 mm Width max 50 mm			<b>H007-22</b>	<b>H007-22</b>	
Flat spec. thickness 0...12 mm Width max 70 mm Round specimens Ø 3...10 mm					<b>H008-21</b>
Flat spec. thickness 12...24 mm Width max 70 mm					<b>H008-22</b>
Flat spec. thickness 24...36 mm Width max 70 mm					<b>H008-23</b>
"V" shape seizing grips for round specimens: Ø 5...12 mm	<b>H005-31</b>	<b>H005-31</b>			
Ø 11...18 mm			<b>H007-31</b>	<b>H007-31</b>	
Ø 18...25 mm			<b>H007-32</b>	<b>H007-32</b>	
Ø 25...32 mm			<b>H007-33</b>	<b>H007-33</b>	
Ø 11...22 mm					<b>H008-31</b>
Ø 23...34 mm					<b>H008-32</b>
Ø 35...45 mm					<b>H008-33</b>
Ø 45...55 mm					<b>H008-34</b>
Compression device	<b>H005-41</b>	<b>H005-41</b>	<b>H007-41</b>	<b>H007-41</b>	<b>H008-41</b>
Knurled roller clamping device	<b>H005-42</b>	<b>H005-42</b>			
Device for test on wire and ropes	<b>H005-43</b>	<b>H005-43</b>			
Flexural and bending device in three spots	<b>H005-44</b>	<b>H005-44</b>	<b>H007-44</b>	<b>H007-44</b>	<b>H008-44</b>
Device to centre the specimens		<b>H005-51</b>	<b>H005-51</b>	<b>H005-51</b>	

**H005-11 - H007-11 - H008-11**

COUPLE OF TENSILE HEADS with different capacities. They are made of treated steel carefully worked and have a shape, which is granting an auto-tightening of the seizing grips on the specimen.

A screw device allows the right operation of the seizing grips and grants a right blocking of the specimen starting from the lowest loads and reducing at the top the moving of the crossbar during the penetration of the knurling on the specimens.

Each couple of tensile Heads is delivered complete with:

- Spanner for the assembling and the disassembling of the seizing Grips.
- Pack of special grease for lubrication.

**H005-21**

FLAT GRIPS - Thickness 0...10 mm  
Width max 25 mm and Round Grips Ø 3...5 mm  
One set consist of a double pair of grips.

**H005-31**

ROUND GRIPS with Section "V"  
Ø 5...12 mm  
One set consists of a double pair of grips.

**H005-41**

COMPRESSION DEVICE  
Consisting of an articulated upper plate and a lower fixed one.

**H005-42**

KNURLED ROLLER CLAMPING DEVICE  
Consisting of a pair of grips with max. capacity 20kN suitable for test on plastic films with a considerable thickness and hardness and similar materials.

**H005-43**

DEVICE FOR TESTS ON WIRES AND ROPES  
Consisting of a pair of self-aligned rollers for tensile tests on wires and ropes of thin section with max. load capacity of 20 kN.

**H005-44**

FLEXURAL AND BENDING TEST DEVICE IN THREE SPOTS  
Suitable for flexural and bending tests on round and flat specimens.

**H005-51**

DEVICE TO CENTRE THE SPECIMENS  
This device is composed by a pair of rollers installed on settable supports screwed on the tensile heads.  
By setting the supports in relation with the dimensions of the specimen, the user will obtain a stop that allows a rapid and right positioning of the specimen in the flat grips.  
This accessory can be used only on machine with 50 kN, 100 kN and 200 kN capacity (models H005N, H006N, H007N).

**H005-44**

## ACCESSORIES FOR MOD. H001A TO H001D, H003N AND MOD. H004N TO H008N

### H014

#### ELECTRONIC EXTENSOMETER

Measuring base 50 mm, Deformation range +1 mm / -0.2 mm

Maximum percent measurable deformation: +2%

It gives the possibility to take the longitudinal specimen deformation during the tensile test.

A load/deformation graph is obtained and the coefficient of elasticity together with the loads RPO.1 - RPO.2 - Rt1 can be identified even on materials that are not presenting a yield point that can be clearly identified.

The appliance is delivered complete with connection cables.

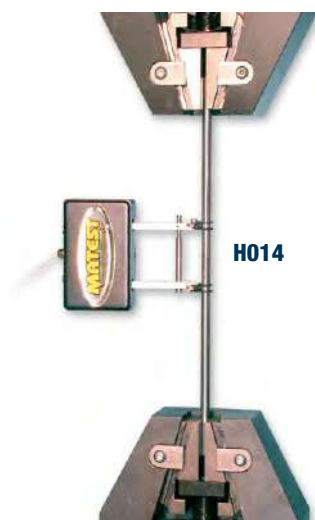

H014

### H003-18

#### WIRE STRANDS EXTENSOMETER

STANDARD: UNI 7676

The instrument is directly applied on the sample through two coaxial telescopic hardened tubes and measures the deformation/elongation of the strand up to failure.

Supplied complete with electronic precision transducer, 50 mm stroke by 0.005 mm sensitivity.

Measuring base: 600 mm

The H003-18 extensometer can be used **only** with model mod. H001BS

**Dimensions:** 105x630 mm

**Weight:** 1000 g



H003-18



## ELECTRONIC EXTENSOMETER FOR TENSILE DEFORMATION STRENGTH TESTS UNTIL BREAKAGE

This electronic coaxial extensometer is used to measure the specimen deformation during tensile test until breakage.

The extensometer is directly fixed to the test specimen and it remains connected until breakage, by measuring the deformation both in the elastic and in the plastic phases.

Measuring base for round specimens: 5 x specimen diameter.

Supplied complete with 4 spacers for the intermediate sample diameters of the specific measuring range, connection cable, accessories, carrying case.



H014-07



### MODELS

- H014-06** Extensometer for round specimens from 4.5 to 11 mm diameter. Transducer stroke: 25 mm
- H014-07** Extensometer for round specimens from 10 to 19 mm diameter. Transducer stroke: 50 mm
- H014-08** Extensometer for round specimens from 18 to 27 mm diameter. Transducer stroke: 50 mm
- H014-09** Extensometer for round specimens from 26 to 36 mm diameter. Transducer stroke: 50 mm
- H014-11** Extensometer for round specimens from 35 to 49 mm diameter. Transducer stroke: 50 mm
- H014-12** Extensometer for round specimens from 48 to 61 mm diameter. Transducer stroke: 50 mm
- H014-10** Extensometer for flat specimens, width max. 25 mm; thickness max. 10 mm  
Measuring base: 25 – 50 – 60 – 70 mm. Transducer stroke: 50 mm



H014-06  
with accessories



## UNIVERSAL TENSILE/COMPRESSION MACHINE



■ TENSILE TESTS ON STEEL REINFORCED BARS, UP TO 500 KN MAX. CAPACITY LOAD.

■ COMPRESSION TESTS ON CONCRETE CUBES / CYLINDERS 1500 KN MAX. CAPACITY LOAD.

STANDARDS: EN 10002 | EN ISO 6892-1, 7500-1, 15630-1 | ASTM C39, E4 | BS 1610 | NF P18-411 | DIN 51220 | AASHTO T22

This machine of compact design, is utilized to carry out tensile tests on steel reinforced bars from diameter 4 to 26 mm and flat max. 25x15 mm. Horizontal and vertical daylightes are now increased for easier specimen handling. It can also carry out compression tests on concrete cube specimens max. side 150 mm and cylinders max. diameter 160x320 mm.

The new and sturdier four columns loading frame is overdimensioned to assure high rigidity and stability. The loading piston, double action, is rectified and lapped. The piston is foreseen of an hydraulic maximum and minimum piston stroke's security device, by avoiding any damage risk due to wrong manipulations of the unit. An hydraulic selector allows to select the tensile or the compression test. The heads holding the jaws are obtained from only one block of high resistance steel. The "V" autoclamping form allows a quick and practical churking of the specimen and the grips locking system ensures safe bar handling after failure. The machine is supplied complete with pair of jaw-holders, but **without** hardened jaws and accessories for tensile and compression tests, which must be ordered separately (see accessories). Hardware technical details see page 18.

### TECHNICAL SPECIFICATIONS

- Maximum tensile load: 500 kN
- Maximum compression load: 1500 kN
- Distance between the jaws:  
min. 345 mm - max. 445 mm
- Distance between the compression platens: 337 mm
- Distance between the columns: 310 mm
- Piston's stroke: 120 mm
- Precision and repeatability:  $\pm 1\%$  of read value
- Power supply: 230V 1ph 50Hz 750W
- Dimensions: 830x530x2000 mm
- Weight: 1150...1200 kg



H010-01N with accessories



H010-02N with accessories

MODEL	Motorized	Gauge	Cyber-Plus Evolution mod. C109N (p. 224)	Servo-Plus Evolution mod. C104N (p. 224)
H010N	▼	▼		
H010-01N	▼		▼	
H010-02N	▼			▼



**H010-02N** with accessories and **C092-09**

### **C092-09**

COMPRESSION FRAME, 2000 kN capacity, connected to the same control unit.

Vertical daylight: 376 mm with a distance piece of 40 mm high, useful to test concrete cubes up to 150 mm side and cylinders up to 160x320 mm with capping retainers.

Technical details: see p. 239

### **Note:**

It is possible to connect different types of compression frames and other frames (up to 2) for many other tests: flexure, splitting, cement, etc.

Ask our technicians for more details.

### **SERVO STRAIN FOR PISTON CONTROL**

#### **C104-10N**

SERVO-STRAIN allowing piston travel control.

#### **H010-31SP**

SUPPORTING DEVICE with displacement transducer, able to grant precise piston travel control.

#### **H009-01**

PERSONAL COMPUTER for remote test execution with a pre-installed software. Complete with LCD, monitor 22", keyboard, mouse, connection cable.

### **Note:**

The PC is recommended, but not necessary: the machine can in any case perform tests without any external PC.



**H010-31SP**

**ACCESSORIES FOR TENSILE TESTS ON ROUND AND FLAT STEEL SPECIMENS**

**H010-10N** SET OF 4 JAWS, upper and lower, for round steel specimens from  $\varnothing$  4 to 15 mm, and flat specimens from 6 to 15 mm thickness (max. width 25 mm).

**H010-11N** SET OF 4 JAWS upper and lower for round specimens from  $\varnothing$  15 to 26 mm

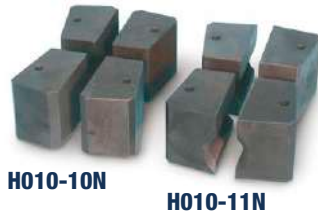

H010-10N

H010-11N

**FOR COMPRESSION TESTS ON CONCRETE CUBE AND CYLINDER SPECIMENS**

**H010-13N** UPPER COMPRESSION PLATEN foreseen of seat ball, fixing device, lower compression platen and distance pieces test cylinders max diameter 160x320 mm and cubes 150 mm max side.

The platens have  $\varnothing$  216 mm and are hardened and rectified as requested by Standards.

**H010-15N** SAFETY GUARDS to CE Directive, polycarbonate made, complete with hinges and lock.



H010-13N

**ACCESSORIES (only for mod. H011N and H011-01N)**

**C127N** GRAPHIC PRINTER on thermal paper

**H009N** SOFTWARE for tensile tests on steel (Load/Deformation, graphics, test certificate etc.).  
Technical details: see p. 18

**C109-10N** SOFTWARE for compression tests on concrete for Cyber-Plus Evolution model H011N

**C123-01N** SOFTWARE "Servonet" for tensile test on steel and compression tests on concrete for Servo-Plus Evolution model H011-01N

**CALIBRATION EQUIPMENT**

**C140-10** LOAD CELL, 500kN Capacity, for tensile calibration test on the Universal Machines H010 to H011-01N  
The load cell has to be connected to the digital tester mod. C138N.  
Technical details: see p. 326

**H011-15** DEVICE to be connected to the Load Cell for Tensile Calibration test.

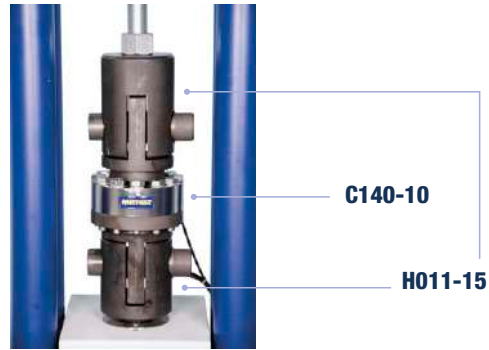

C140-10

H011-15

**H014 ELECTRONIC EXTENSOMETER**

Measuring base 50 mm, Deformation range +1 mm / -0.2 mm  
Maximum percent measurable deformation: +2%

It gives the possibility to take the longitudinal deformations of the specimen during the tensile test. A graph load/deformation is obtained and from this graph the coefficient of elasticity together with the loads RPO.1 - RPO.2 - Rt1 can be identified even on materials that are not presenting a yield point that can be clearly identified. The appliance is delivered complete with connection cables.



H014

**ELECTRONIC EXTENSOMETER FOR TENSILE DEFORMATION STRENGTH TESTS UNTIL BREAKAGE**

This electronic coaxial extensometer is used to measure the deformation of a specimen under tensile test until breakage.

The extensometer is directly fixed to the test specimen and it remains connected until breakage, by measuring the deformation both in the elastic and in the plastic phases. Measuring base for round specimens: 5 x specimen diameter. Supplied complete with 4 spacers for the intermediate sample diameters of the specific measuring range, connection cable, accessories, carrying case.

**MODELS**

**H014-06** Extensometer for round specimens from 4 to 11 mm diameter.  
Transducer stroke: 25 mm

**H014-07** Extensometer for round specimens from 10 to 19 mm diameter.  
Transducer stroke: 50 mm

**H014-08** Extensometer for round specimens from 18 to 27 mm diameter.  
Transducer stroke: 50 mm

**H014-10** Extensometer for flat specimens, width max. 25 mm; thickness max. 10 mm.  
Transducer stroke: 50 mm  
Measuring base: 25 - 50 - 60 - 70 mm



H014-07

## ACCESSORIES FOR MOD. H001A TO H001D, H003N, MOD. H004N TO H008N, MOD. H011N AND MOD. H011-01N

### H009N UTM2 SOFTWARE

STANDARDS: EN 10002-1 | ISO 527, 178, 604, 898-1, 3506-1,  
10113, 12275 | ASTM A370

This Software has been developed on the base of Microsoft Windows operating system.

This interactive software is the ideal solution for an effective and complete management of the material testing.

It is composed by many test procedures in conformity with the International Standards for metal, plastic, cement, wood and composed materials.

This software supports a wide range of calculation and profiles for tensile, compression and flexural tests.

The user can create new personalised test profiles: definition of the test data such as test date, certificate number, lot of material delivered, specimen origin, test temperature, etc. and definition of the specific dates of the specimen as type, dimensions measuring unit, etc.

The user can select and set the calculation corresponding to the activated standard. As an example for the Standard EN 10002-1 he can select the initial length, the initial section of the specimen, the calculation of the maximum load, the unit load, the elastic limits (ReH, ReL, Rp%), the restriction, the Young's Modulus, etc.

For some calculations the end user may set test execution parameters for the corresponding calculation algorithms, for example the percentage (%) for the standard deviation of the Rp proportionality.

The software allows a speedy and easy management of all the machine parameters such as the management of the load acquisition by means of a load cell, the specimen deformations by means of an extensometer and the crossbar displacement. For each one of the analogical channels, the user can set the calibration and visualisation measuring unit, the limits of use: alarm, start limit of the test calculation, etc.

The test process is divided in different phases or speed charts, where the user can set the required type of control (pace rate, load/time, deformation/time), the tare and the zero option, the limits and the phase or speed changes.

The end of the test mode or the breaking limit can also be selected. The software allows user to personalise and set the displayed parameters of the test graph as the colour, the title of the Cartesian axis, the colours of the load/deformation limits and the certificate parameters such as titles, margins etc.

At the end of the test, the user can decide if the selected calculations must be performed or filed. In any moment all the tests made are available to make an analysis of the results or to print their certificate.

Graphic analysis of the test can be made by means of the zoom function.

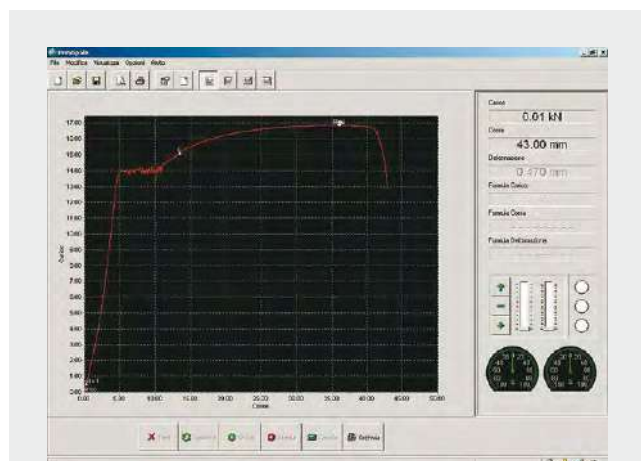

Tensile test on a steel specimen without extensometer; it displays the yield point with the possibility of increasing the dimensions of the graph area by means of the zoom function.

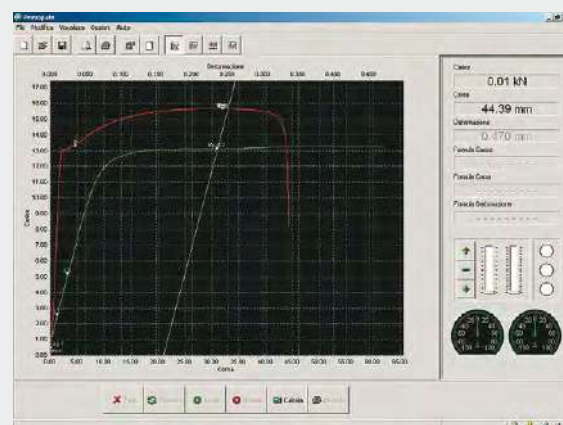

Tensile test on a steel specimen using an extensometer; showing the symbols of the considered dimensions and the relative tracing in different colours selected by the user.

TENSILE TEST			
Date		Specimen	
Date	10/11/2008	Type	Round
Test n°	1032185	Diameter	12 mm
Laboratory	MATEST	Section	118,987 mm²
Temperature	26 °C		
<b>Speed</b>			
Test	0	(N/mm²)	
Taux	0	(N/mm²)	
<b>Results</b>			
Initial length	La	500	mm
Final length	Ld	445	mm
Measuring base length	Lc	09	mm
Initial section	S0	118,987	mm²
Breakage at breakage	A	8,2	%
Maximum load	Fm	12,535	kN
Tensile strength	Rm	641,278	N/mm²
Unit load at elastic limit	Rp 0,1	642,772	N/mm²
Unit load at elastic limit	Rp 0,2	642,754	N/mm²
Young's modulus	E	200,824	N/mm²

Example of the certificate



### C128

LASER PRINTER, bench model,  
for graphics and certificates with  
direct connection via USB.

## H017 UNIVERSAL EDUCATIONAL TESTING MACHINE CAPACITY 20 KN



The machine has been designed to measure strength of metallic materials and study the various reactions they undergo when subject to different stresses, verifying the same with the following tests:

- Tensile test
- Shear test
- Compression test
- Flexural test
- Brinell hardness

This machine is primarily for educational purposes and intended for the use in higher educational institutes or universities and allows students of material science to have a hands-on approach to applications so far studied at a theoretic level only.

Components of the machine:

- 30 kN (160 bar) manometer
- 50 mm full scale analog dial indicator
- 250 bar pressure transducer
- 50 mm travel displacement transducer
- 8-channel digital indicator

**Power supply:** 230V 1ph 50-60Hz 70W

**Dimensions:** 600x600x850 mm

**Weight:** 60 kg



H017

### ACCESSORIES THAT CAN BE USED IN THE UPPER CHAMBER OF THE MACHINE

#### H017-05

##### TENSILE TEST

The equipment allows to perform tensile tests on steel samples up to failure and serves to evaluate stress-strain diagrams of the material comprising the sample and mainly to evaluate the following parameters:

- Yield strength
- Proportionality limit
- Failure strength
- Elastic modulus
- Ultimate strength

The accessory includes: tensile heads for round samples and tensile heads for flat samples.

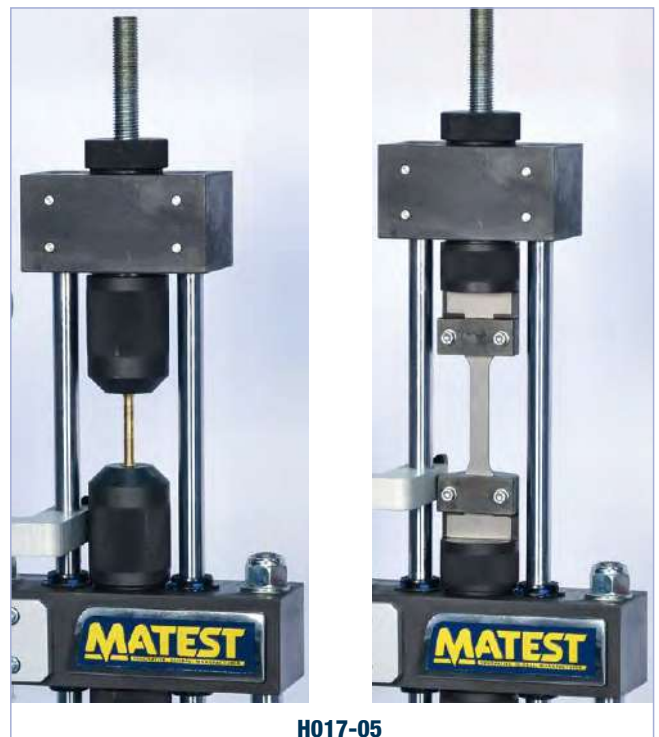

H017-05

**H017-10****SHEAR TEST**

The equipment allows to perform shear tests on 6 mm diameter samples so as to determine strength:

$$T = F/S$$

F = value of measured force

S = value of sectional area

The shear strength of the sample may be compared to its tensile strength.

The accessory includes: shear heads and connecting rod.

**H017-10****H017-20****FLEXURE TEST**

The equipment is used to determine material strength and maximum deflection.

- F = applied force

- L = the distance between supporting bearers

The accessory includes:

two lower rollers, one upper loading roller and lower transverse.

**H017-20****ACCESSORIES THAT CAN BE USED IN THE LOWER CHAMBER OF THE MACHINE****H017-15****COMPRESSION TEST**

The equipment allows to determine the mechanical properties of various materials, using a spring as sample with the constant factor K, given by the ratio between the force applied and measured via the manometer and the displacement measured on the dial gauge, or using anisotropic material to define the compressive strength.

The accessory includes: two compression platens and a distance piece.

**H017-15****H017-25****HARDNESS TEST**

The equipment is used to determine the capacity of a material to resist when engraved, indented or impressed and is useful for studying materials subject to wear. It is performed following the Brinell method: the diameter of the sphere used may be 10, 5, 2 or 1 mm. The accessory includes: upper hardness head and lower compression platen.

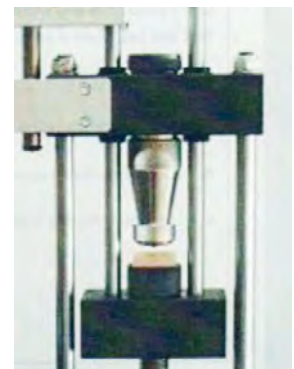
**H017-25****SAMPLE SPECIMENS FOR THE DIFFERENT TESTS**

CODE	DESCRIPTION
<b>TENSILE TEST</b>	
<b>H017-30</b>	Round bar test specimens $\varnothing$ 6 mm made in stainless steel AISI 303, set of 14 pieces.
<b>H017-31</b>	Round bar test specimens $\varnothing$ 6 mm made in brass, set of 14 pieces.
<b>H017-32</b>	Round bar test specimens $\varnothing$ 6 mm made in bronze, set of 14 pieces.
<b>H017-33</b>	Round bar test specimens $\varnothing$ 6 mm made in copper, set of 14 pieces.
<b>H017-34</b>	Round bar test specimens $\varnothing$ 6 mm made in aluminium, set of 14 pieces.
<b>H017-40</b>	Flat bar test specimens, different materials, set of 14 pieces.
<b>SHEAR TEST</b>	
<b>H017-50</b>	Round copper bar specimens $\varnothing$ 6 mm, set of 14 pieces.
<b>FLEXURAL TEST</b>	
<b>H017-60</b>	Flat bar specimen, set of 14 pieces.



The machine is manually controlled, while readings are both analog, through the manometer and the dial indicator, and digital, through the pressure transducer and the displacement transducer connected to the digital indicator.

**H009N****UTM2 SOFTWARE**

The software allows to see graphs created in real time during the test, and to elaborate a test report.

For further details refer to p. 449

## S205-05N UNITRONIC 50 KN

UNIVERSAL MULTIPURPOSE TOUCH-SCREEN FRAME FOR:

- TENSILE TESTS, 25 kN MAX. CAPACITY LOAD
- COMPRESSION/FLEXURAL TESTS, 50 kN MAX. CAPACITY LOAD

WITH AUTOMATIC LOAD OR DISPLACEMENT/DEFORMATION CONTROL.

The load is applied by a mechanical jack that is driven by a motor brushless with closed loop through optic encoder and controlled by a microprocessor. Stroke electric end switches are applied to the load piston to save the machine from accidental handlings. The control panel is placed frontally and it is provided with a membrane having 6 multifunctional interactive pushbuttons driven by menu, a large graphic display and RS232 port for connection to PC.

### TENSILE TESTS ON METALS, PLASTICS, WIRES, TEXTILES ETC.

Test development with load control

#### NEEDED ACCESSORIES for metal flat and round specimens

- S337-36** TENSILE STRAIN load cell 25kN capacity
- H005-11** TENSILE HEADS (upper and lower)
- S205-09** DEVICES to fix the tensile heads to the frame
- H005-21** FLAT SEIZING GRIPS for flat specimens 1 - 10 mm thickness by 25 mm max. width and round specimens  $\varnothing$  1 - 5 mm
- H005-31** "V" SHAPE SEIZING GRIPS for round specimens  $\varnothing$  5 - 12 mm

#### OPTIONAL ACCESSORIES

- H014-06 - H014-10** EXTENSOMETER, electronic, for tensile deformation strength tests.
- H009N** SOFTWARE for visualisation in real time of load/deformation, graphic, test certificate etc.

#### Various materials:

By using suitable devices, Unitronic tester, within the limits of its max. 50 kN capacity for compression/flexural performs compression, flexural, splitting tensile and direct tensile tests on: Concrete, Cement, Rocks, Bituminous Materials, Soil etc., with automatic load or displacement/deformation control.

Unitronic technical details and additional specific tests: see p. 500

## S206N UNITRONIC 200 KN

UNIVERSAL MULTIPURPOSE TOUCH-SCREEN FRAME FOR:

- TENSILE TESTS, 50 kN MAX. CAPACITY LOAD
- COMPRESSION/FLEXURAL TESTS, 200 kN MAX. CAPACITY LOAD

WITH AUTOMATIC LOAD OR DISPLACEMENT/DEFORMATION CONTROL.

Unitronic technical details and additional specific tests: see p. 508



S205-05N with load cell



S205-05N + accessories for tensile test



S206N

## H020 MARKING-OFF MACHINE

### AUTOMATIC MOTORISED

STANDARD: UNI 556

Used to mark off specimens with round, square shape and with improved bond for the measurement of the percentage elongation after their breaking, in accordance with the Standards.

The machine can mark specimens as follows:

- Round from 4 mm up to 50 mm diameter.
- Flat from 4 mm up to 50 mm thickness.
- Square from 4 mm to 45 mm side.

Useful marking length 500 mm

Max. specimen length 900 mm

Marking steps: 5 or 10 mm selectable with lateral graduation.

Marking speed: 60 marks per minute.

**Power supply:** 400V 3ph 50Hz

**Dimensions:** 530x480x445 mm

**Weight:** 58 kg approx.



H020

## H021 MARKING-OFF MACHINE

Same as mod. H020, but hand operated by rotating the handle.

Max. specimen length 1200 mm



H021

## H050 DRY-ICE MAKER

This device instantaneously produces the quantity of dry ice (solid CO<sub>2</sub>) required to reach temperatures down to -80 °C.

The dry-ice maker must be connected to a liquid CO<sub>2</sub> bottle with connecting pipe and it produces 100 g dry-ice tablets, having mm 75 diameter and mm 25 thickness.

**Weight:** 3 kg



H050

## H052 COOLING BATH FOR RESILIENCE TESTS

This apparatus is meant for Charpy tests to be carried out at low temperatures.

It is made from double chambered stainless steel with isolating cavity wall from foamed polyurethan, 65 mm thick.

Complete with double chambered cover and specimen rack.

**Internal dimensions:** 125x125x180 mm

**Weight:** 12 kg



H052

H054

## H054 PLIERS

Special-shaped, to take cooled specimens from the bath and place them directly into the Charpy Pendulum.

## H057N BROACHING MACHINE, MOTORIZED

STANDARDS: ASTM A370 | ISO 148

Used to make notchings on impact test bars for resilience tests.

The notch on the specimen is obtained by only one tooling with very high dimensional accuracy.

Broach length: 350 mm

Speed notch: adjustable from 0.5 to 4 mm/sec

Drive: hydraulic, semi-automatic.

Suitable for KV, KU, KCU, DVM broach

**Power supply:** 400V 3ph 50-60Hz 400W

**Dimensions:** 460x610x1600 mm

**Weight:** 100 kg approx.



H057N

## ACCESSORIES

**H057-10N** BROACH for "V" notchings on specimens with square section 10x10 mm

**H057-11N** BROACH for "U" notchings on specimens with square section 10x10 mm

## C351 SPECIMEN CUTTING MACHINE

It accepts blades up to Ø 350 mm

Shear capacity: 120 mm

Complete with cutting blade for metals Ø 350 mm

**Power supply:** 230V 1F 50 Hz 2000W

**Dimensions:** 560x460x390 mm

**Weight:** 20 kg



C351



## H065N COLD BEND TESTING MACHINE

STANDARDS: EN ISO 7438, EN ISO 15630-1 | ASTM A615, ASTM A615M | D.M. 14/1/1988

This equipment has been studied and designed to perform bending tests on steel bars for reinforced concrete.



### SPECIFICATIONS:

- Max. piston load: 160 kN
- Max. piston stroke: 550 mm
- Piston speed adjustable from 0 to 6 mm/s
- Power supply: 230V 1ph 50 Hz 1500W
- Dimensions: 1540x800x1300 mm
- Weight: 350 kg approx.

The machine can perform two types of test:

- bending the specimen through 180° only with mandrels up to max. 96 mm included.
- bending the specimen through 90° and then straightening it again up to a minimum of 20° only with mandrels over 96 mm diameter.

This bending machine is composed of a rugged frame supporting a beam having a cylinder with relevant load piston fixed on it, being activated by an hydraulic cell complete with speed adjuster for the piston, direction control valve, max. pressure valve, control gauge. The whole is cased to protect every single component from the dust, and the operator from any possible danger. A small bowl has been fitted under the beam, where the steel bar is bent.

Two contrasting rollers are fitted on the beam. They may easily be adjusted in distance to be in accordance with the Standards concerning bars having diameter between 5 and 40 mm.

Fixing and changing the mandrels on top of the thrust cylinder is easy and practical and grants the operator a perfect interchangeability of the same. A device prevents the unlocking of the bar under test from the relevant rollers and the contrasting mandrel both during the bending and the straightening operation.

The machine accepts bars up to  $\varnothing$  40 mm and is supplied complete with two series of rollers, having respectively  $\varnothing$  mm 50 and 100.

The mandrels, the mandrel-holders and the brackets are not included in the standard supply and have to be ordered separately. (see table).

### ACCESSORY

**H065-01** SAFETY GUARDS to CE Safety Directives.



TABLE OF THE AVAILABLE MANDRELS AND BRACKETS FROM Ø 5 TO Ø 40 ACCORDING TO: EN, ASTM, D.M.

Mandrel Model	Mandrel Ø mm	Rebar Ø mm EN ISO 15630-1	Rebar Ø mm ASTM A615-A615M	Rebar Ø mm D.M. 14-01-08	Mandrel-Holder Model	Bracket Model	Bracket Distances mm
H066-07	24	4 e 6	-	6	H067-03	H068-12	80, 170, 226
H066-10	32	7	9,5	8	H067-03	H068-17	98, 196
H066-12	40	8	-	10	H067-03	H068-17	98, 196
H066-14	44	-	12.7	-	H067-03	H068-13	85, 172, 298
H066-15	48	-	-	12	H067-03	H068-11	75, 160, 262
H066-18	56	10	15.9	-	H067-04	H068-20	110, 244
H066-19	60	-	-	12	H067-04	H068-13	85, 172, 298
H066-20	64	12	-	-	H067-04	H068-13	85, 172, 298
H066-61	70	-	-	14	H067-04	H068-19	106, 226
H066-62	80	-	-	16	H067-04	H068-20	110, 224
H066-24	96	14	19	-	H067-04	H068-12	80, 170, 226
H066-28	112	16	22.2	-	* No	H068-21	120, 254
H066-30	128	18	25.4	-	* No	H068-13	85, 172, 298
H066-31	132	20	-	-	* No	H068-01	200, 260, 412
H066-32	140	22	-	-	* No	H068-05	232, 342, 516
H066-33	144	-	-	18	* No	H068-13	85, 172, 298
H066-35	160	-	-	20	* No	H068-09	230, 320, 490
H066-36	176	-	-	22	* No	H068-05	232, 342, 516
H066-37	180	24 e 26	-	-	* No	H068-07	244, 364, 550
H066-49	192	-	-	24	* No	H068-07	244, 364, 550
H066-38	200	28	28.7	25	* No	H068-08	250, 375, 580
H066-40	224	30 e 32	32.2	-	* No	H068-05	232, 342, 516
H066-41	250	-	35.8	-	* No	H068-05	232, 342, 516
H066-53	260	-	-	26	* No	H068-03	220, 280, 438
H066-43	280	-	-	28	* No	H068-04	225, 292, 464
H066-45	320	34 e 38	-	32	* No	H068-22	122, 542, 594
H066-46	336	40	-	-	* No	H068-23	134, 568, 620
H066-58	340	-	-	34	* No	H068-22	122, 542, 594
H066-60	400	-	-	40	* No	H068-23	134, 568, 620

TABLE OF OTHER AVAILABLE MANDRELS AND BRACKETS

Mandrel Mod.	Ø mm Mandrel	Mandrel-Holder Mod.
H066-01	10	H067-01
H066-02	12	H067-01
H066-03	15	H067-02
H066-04	16	H067-02
H066-05	18	H067-02
H066-06	20	H067-02
H066-08	28	H067-03
H066-09	30	H067-03
H066-11	36	H067-03
H066-13	42	H067-03
H066-16	50	H067-03
H066-51	52	H067-04
H066-17	54	H067-04
H066-21	66	H067-04

Mandrel Mod.	Ø mm Mandrel	Mandrel-Holder Mod.
H066-48	72	H067-04
H066-22	75	H067-04
H066-52	78	H067-04
H066-23	84	H067-04
H066-55	90	H067-04
H066-26	108	* No
H066-63	114	* No
H066-39	220	* No
H066-50	240	* No
H066-56	300	* No
H066-54	312	* No
H066-57	360	* No
H066-59	380	* No
H066-47	384	* No

Bracket Model	Bracket Distances mm
H068-02	210, 268, 425
H068-06	240, 360, 520
H068-10	256, 386
H068-14	86, 180

Bracket Model	Bracket Distances mm
H068-15	90, 184
H068-16	92, 190
H068-18	100, 208

 **\*Note:** From Ø 100 to 400 mm the mandrel is directly fitted to the piston without using a mandrel-holder.

All mandrels have been produced from quality steel and cadmium plated for rust protection, and from Ø 10 mm up to Ø 96 mm included have been hardened to make them wearproof.

## PENDULUM IMPACT CHARPY TESTERS FOR RESILIENCE TESTS

STANDARDS: EN 10045-1 | EN ISO 148-1 | ASTM E23 | BS 131

### AVAILABLE MODELS

#### H060N PENDULUM IMPACT CHARPY TESTER HAND OPERATED

The tester is equipped with a falling pendulum hammer, able to break, with a single blow, a sample carved in the middle and positioned on two supports.

The test is carried out on a CHARPY sample in order to check the energy absorbed during the impact, which is measured in JOULE. The value stands for the impact strength of the material (resilience).

- Cast iron frame
- Pendulum with hardened knife
- Brake device to stop the pendulum
- Impact energy 300J with 2J graduation
- Falling angle: 140°, Pendulum mass kg. 21.300
- Impact speed: 5.187 m/s

Supplied complete with knife-edge to perform the test as per ASTM Standard

It cannot be sold in CE markets

**Dimensions:** 500x1000x1820 mm **Weight:** 400 kg approx.

#### H062 PENDULUM IMPACT CHARPY TESTER, MOTORIZED

Semi-automatic working and high energy capacity.

Motorized pendulum with immediate arm repositioning.

Mechanical safety with automatic insertion to the arm hooking.

Simple and fast utilization, ideal for routine tests.

Supplied complete with protection cage to CE Safety Directive.

Impact energy: 300J with 0.25J resolution.

Supplied complete with knife-edge to perform the test as per ASTM Standard.

**Power supply:** 230V 1ph 50Hz 180W

**Dimensions:** 800x578x1400 mm **Weight:** 450 kg approx.



**H062**

### ACCESSORY

KNIFE-EDGE to perform resilience tests according to EN 10045-1, EN ISO 148-1 and BS 131 Standards

**H060-03** KNIFE-EDGE for H060N tester.

**H062-03** KNIFE-EDGE for H062 and H062-01 testers.



**H060N**

#### H062-01 PENDULUM IMPACT CHARPY TESTER, MOTORIZED, DIGITAL, HIGH PERFORMANCE

Fully automatic working with immediate arm repositioning.

Machine for resilience tests with high impact energy.

Suitable for steels and alloys with high resilience values.

Data acquisition to PC through Software.

Safety cage aluminium and plexiglass made, with mechanical safety and microswitch blocking the door when the arm is inserted.

Impact energy: 500J with 0.1J resolution.

Supplied complete with knife-edge to perform the test as per ASTM Standard.

**Power supply:** 380V 3ph 50Hz 400W

**Dimensions:** 2200x800x2300 mm

**Weight:** 750 kg approx.



**H062-01**

OUR **CLIENTS** ARE OUR BEST  
ADVERTISEMENT.

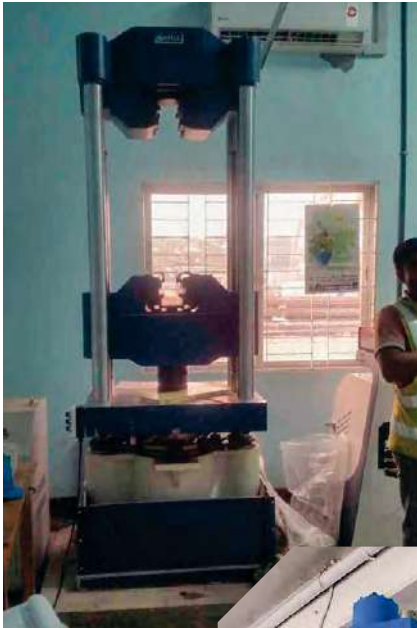



SHEARLAB

SHEARLAB

MATEST

TOUCH

CE

CE

CE

MATEST

# SECTION S

## SOIL



For the implementation of civil engineering structures, the engineers must base their calculations according to the soil properties.

This section analyses a soil sample to evaluate its characteristics, by providing a complete range of testing equipment for: sampling, preparation, classification, consolidation, shear strength, triaxial, compaction, penetration, bearing capacity, permeability, density, geotechnical and chemical tests, in compliance with the EN, ASTM, BS and the most known International Standards.

### **TECNOTEST**

#### **MATERIAL TESTING EQUIPMENT**

In early 2017 Matest has acquired Tecnotest.

The famous elephant has always been appreciated from the construction material industry for the quality and the stiffness of its products, with a special focus on the geotechnical range. We are happy to have Tecnotest now part of our group.



## S050 LIGHTWEIGHT DYNAMIC PENETROMETER

STANDARD: DIN 4094

Used to establish the thickness of different strata, when testing compaction works and to determine the relative density of fills and naturally deposited non-cohesive soils.

In general if the ground is not too compact, penetration tests can be carried out about 8 to 12 metres.

The penetrometer set, housed in carrying case, consists of:

- 10 kg drop rammer, 500 mm fall and anvil,
- 11 sounding rod  $\varnothing$  22 mm x 1 m length complete with threaded collar and guiding rod
- Grooved rod to extract samples
- 2 drive point 90°, 5 cm<sup>2</sup> and 10 cm<sup>2</sup> surface
- Lifting device for sounding rod, accessories

**Dimensions:** 1080x360x220 mm

**Weight:** 72 kg approx



S050

## S051 DYNAMIC CONE PENETROMETER (DCP)

TRL = TRANSPORT RESEARCH LABORATORY, UK.

STANDARD: ASTM D 6951-03

This portable hand operated equipment is designed to obtain a direct and rapid in-situ evaluation of the structural strength of road pavement layers constructed with unbound materials.

The DPC Penetrometer results can be compared with CBR (California Bearing Ratio) as per experimental Kleyn 1982 studies. The test is performed with continuous penetrations at approx. 800 mm depth with max. depth of 2 m by using extension rods.

The equipment housed in carrying case, consists of:

- Drop sliding hammer 8 kg weight, falling height of 575 mm
- Impact anvil with driving rod
- Penetration rod with conical 60° point and  $\varnothing$  20 mm
- Bar wrench, spanners, accessories.

**Dimensions:** 1210x340x190 mm

**Weight:** 29 kg approx

### ACCESSORIES | SPARE

**S051-10** Drop Sliding Hammer 4.6 kg weight.

**S051-12** Extension rod, 400 mm long

**S051-11** Spare Penetration conical point 60°

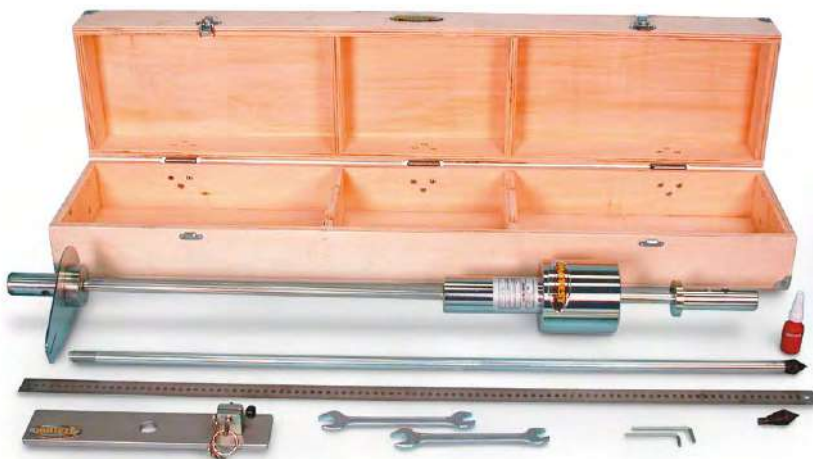

S051

## S057 FIELD INSPECTION POCKET VANE TESTER

STANDARD: ASTM D 2573

Used to determine the shear strength of undrained (CU) cohesive soft soils, to firm non-fissured soils on site.

The instrument consists of a T-handle cylindrical body where a torsional spring is housed, and three interchangeable vanes of different sizes, used depending to the expected strength of the soil to be tested.

The vane is inserted into the soil for 60 mm approx., and the max. torque value is measured on a collar attached to the shaft.

Measuring range: 0 - 240 kPa

The unit, all stainless steel made, is supplied **calibrated with calibration certificate and conversion table** and complete with three vanes dimensions (diameter x height) 16x32, 20x40, 25.4x50.8 mm, extension rod 500 mm long, tools, carrying case.

**Dimensions:** 500x300x100 mm

**Weight:** 4 kg approx.

### ACCESSORY | SPARE

**S057-01** Extension rod, 500 mm long



S057



S051-01

### S052KIT SOIL PROSPECTING KIT

STANDARDS: ASTM D420, D1452 | AASHTO T86

This equipment, manufactured by Matest, comprises different augers, sampler and tools for soil investigations; the whole housed in a wooden carrying case.

The kit consists of:

- S092-01** Auger head Ø 80 mm
- S093-01** Auger head Ø 100 mm
- S094-01** Auger head Ø 150 mm
- S052-01** Dutch soil auger head, Edelman type, Ø 150 mm
- S052-02** Gravel auger head Ø 50 mm
- S092ASTA** Extension rod 1 m long with "T" handle
- S095** n° 5 extension rods, 1 m long
- S053** Soil sampler Ø 38 mm complete with stainless steel sample tube Ø 38x230 mm, jarring link, "T" handle.
- S053-04** n° 5 Stainless steel sample tubes Ø 38x230mm
- S052-03** Plastic cap ends for sample tubes Ø 38x230mm (12 pieces)
- S054** Hand extruder for sample tube Ø 38x230 mm
- S052-04** Stillson wrenches (2 pieces)
- S052-05** Wooden carrying case.

**Dimensions:** 1140x490x360 mm

**Total weight:** 50 kg approx.

### S051-01 MACKINTOSH PROSPECTING KIT

This equipment, manufactured by Matest, is particularly useful for initial site investigation work in remote areas. The kit is capable boring to a depth 10 - 12 mtrs depending on ground conditions. The use of specially designed extension rod couplers reduces bore-hole friction to a minimum, permitting easy operation to considerable depth.

Equipment consists of:

- 12 boring rods 1 mtr long with 12 couplers
- 2 pipe wrench and 1 tap wrench
- Core tube adaptor and clay core tube
- Driving head and clearing rod
- Long and short driving point
- Auger tool and standard core tube
- Lifting/driving tool and hammer
- Die nut and hand tap

All equipment supplied in a strong wooden box

**Dimensions:** 1050x260x120 mm

**Weight:** 35 kg approx.



S052 KIT



## HAND AUGERS

STANDARDS: ASTM D 420, D 1452 | AASHTO T86, T202

Designed for soil investigations and explorations, and to obtain representative samples.

Complete with "T" handle, and rod 1 m long.

Made of special galvanized steel.



Models	Description	Weight kg
<b>S092 KIT</b>	Hand Auger, Ø 80 mm x 1 m long	4
<b>S093 KIT</b>	Hand Auger, Ø 100 mm x 1 m long	5
<b>S094 KIT</b>	Hand Auger, Ø 150 mm x 1 m long	6
<b>S095</b>	Extension rod for above 1 m long complete with coupling device	2

## AUGER POWER HEAD TO OBTAIN DISTURBED SOIL SAMPLES.

Supplied **without** augers, to be ordered separately (see accessories).

### MODELS

#### S096 AUGER POWER HEAD

Motor capacity 3 HP, two strokes, without speed inverter. Fitted with two handwheels, to be used just by one operator. Drilling holes up to Ø 200 mm and max. depth of 1000 mm. It does not accept extension rods. Supplied without augers (see accessories)

**Weight:** 10 kg approx.

### ACCESSORIES

- S096-03** AUGER Ø 100 mm x 1 m long
- S096-04** AUGER Ø 150 mm x 1 m long
- S096-05** AUGER Ø 200 mm x 1 m long
- S096-06** EXTENSION ROD 1 m long



**S096**



**S097**

#### S097 AUGER POWER HEAD

Motor capacity 6 HP, two strokes, equipped **with speed inverter** to facilitate the extraction of the augers. Fitted with two handwheels, to be used by two operators. Supplied without augers (see accessories)

**Weight:** 30 kg approx.

### ACCESSORIES

- S097-03** AUGER Ø 100 mm x 1 m long
- S097-04** AUGER Ø 150 mm x 1 m long
- S097-05** AUGER Ø 200 mm x 1 m long
- S097-06** EXTENSION ROD 1 m long

## SURFACE SOIL SAMPLERS

Used to take field standard core samples of compacted fill or undisturbed soils and to evaluate density of compaction samples as the ground surface.

The set consists of a drop hammer sliding on the drive rod and falling on the drive head where the sampling tube is hold. Steel made, galvanized against corrosion.

### MODELS

#### S084 KIT

#### SURFACE SOIL SAMPLER 73 MM ID

STANDARDS: ASTM D2937 | CNR no. 22

Sampling tube is 73 mm inside diameter by 66 mm high.

Drop hammer is 5 kg

**Total weight:** 10 kg approx.

### SPARE

**S084-01** Sampling tube 73 mm diameter by 66 mm high.

#### S083 KIT

#### SURFACE SOIL SAMPLER 100 MM ID

STANDARD: BS 1377:9

The sampling tube (core cutter) is driven into the soil by using the rammer dropping on the driving dolly.

The sampled specimen is trimmed weighed and dried; the density and the moisture content % is calculated. Manufactured of plated steel.

The S083KIT includes:

**S083-01** Driving rammer for Ø 100 mm core cutter.  
Weight 7.5 kg

**S083-02** Driving dolly for Ø 100 mm core cutter.  
Weight 1 kg

**S083-03** Core cutter (sampling tube) Ø 100 mm by 130 mm length. Weight: 1 kg

**Total weight:** 9.5 kg approx.

## WATER LEVEL INDICATORS

Utilized to measure the water level in boreholes, wells and any open underground structures. A light and audible signal are activated when the probe touches water.

Battery operated, the cable is marked at cm. intervals, drum mounted and the stainless steel tip has diameter of 10 mm

**Weight:** 6 kg approx.



**S061**

Models	Cable length
<b>S061</b>	50 m
<b>S061-01</b>	100 m
<b>S061-02</b>	200 m



**S053-04**

**S053**

**S054**

**S084 KIT**

**S083 KIT**

#### S053

#### SOIL SAMPLER Ø 38 MM

Used to obtain indisturbed soil samples of Ø 1½" (38 mm)

The sampler is formed by:

T handle with extension rod, 900 mm long

Jarring link ¾"

Stainless sample tube Ø 1½" x 9" (38x230 mm).

Weight: 7 kg

### ACCESSORY

**S054** HAND EXTRUDER used to extrude the soil specimens Ø 1½" from the sample tube.

### SPARE

**S053-04** Stainless sample tube Ø 1½" x 9"

## POCKET PENETROMETERS AND SHEAR VANE DEVICES

STANDARDS: ASTM D 2573-94 | AASHTO T202



### MODELS

#### S065

##### DIAL POCKET PENETROMETER

For the classification of cohesive soft soils in terms of consistency, shear strength and approximate unconfined compression strength. Direct value read in  $\text{kgf/cm}^2$  on the graduated dial.

Range 0 - 6  $\text{kgf/cm}^2$  (0-588 kPa). Peak hold feature; zero setting by push button. Plunger  $\varnothing$  6.35 mm

**Weight:** 300 g

#### S066

##### DIAL POCKET PENETROMETER

Identical to mod. S065 but with dial range 1-14  $\text{kg f/cm}^2$  (0-1373 kPa), suitable for medium and hard soil. Plunger  $\varnothing$  6.35 mm

#### S068

##### GEOPOCKET DIAL PENETROMETER

Designed for a quick determination of the foundation soils, from clay to sandy soils.

It indicates:

- The angle of internal friction (sandy soils)
- The cohesion "c" (clay soils) and the approx. Unconfined Compressive Strength.

Peak hold feature; zero setting by push button.

Dual scale: 0-6  $\text{kgf/cm}^2$  (0-588 kPa)  
0-11  $\text{kgf/cm}^2$  (0-1079 kPa)

Complete with 5 plungers  $\varnothing$  6.4 - 10 - 15 - 20 - 25 mm

**Weight:** 400 g

#### S070

##### STANDARD POCKET PENETROMETER

Designed for the rapid determination of soil consistency, shear strength and approximate Unconfined Compression Strength. Scale range 0-4.5  $\text{kgf/cm}^2$  with direct reading strength values.

Plunger  $\varnothing$  6.35 mm

**Weight:** 300 g

#### S071

##### POCKET PENETROMETER

Identical to mod. S070, but having a range of 0 - 16  $\text{kgf/cm}^2$ . Suitable for very compacted soils.

**Weight:** 800 g.

#### S075

##### POCKET SHEAR VANE DEVICE RANGE: 0-1 $\text{KG/CM}^2$

Designed for the rapid determination in the field or in the laboratory of shear strength of cohesive soils. The dial indicates directly the shearing strength in  $\text{kg/cm}^2$ .

Complete with interchangeable stainless steel vane, 10x20 mm ( $\varnothing$  x height)

**Weight:** 300 g.

#### S076

##### POCKET SHEAR VANE DEVICE RANGE: 0-2 $\text{KG/CM}^2$

Identical to mod. S075 but dial range 0-2  $\text{kg/cm}^2$ .

### SPARE

**S076-01** Stainless steel vane 10x20 mm ( $\varnothing$  by height) for S075 and S076 devices.

#### A106

MELTING POT, to melt wax and to cover soil samples keeping them to the original humidity. See section "A" p. 28



**A106**

## S086 LOAD RING PENETROMETER

Used to determine the bearing strength, compaction degree of subgrades, and also for determining the static penetration resistance of soil.

Supplied complete with "T" handle, proving ring 100 kgf (1 kN) with maximum load pointer and calibration chart, extension rod 500 mm long graduated every 100 mm, removable cone point 30° with 1 sq. in. top area.

Cadmium plated against corrosion.

**Weight:** 5 kg approx.



S086

## S088 PROCTOR PENETROMETER

STANDARD: ASTM D 1558

Used to determine in field the moisture-penetration resistance relationship of fine grained soils.

Spring load scale 0-40 kg, subdiv. 1 kg, with direct max. value reading in kg on the sliding rod.

Complete with 9 interchangeable stainless steel needles diameter: 4.52 - 5.23 - 6.40 - 9.07 - 12.83 - 16.54 - 20.22 - 24.79 - 28.55 mm, accessories, carrying case.

Chromed finishing.

**Weight:** 5 kg approx.



S088

## S088-10 MOISTURE CONDITION VALUE (MCV) AND CHALK CRUSHING VALUE (CCV)

STANDARDS: EN 13286-46 | BS 1377:4 (TRL approved)

This apparatus is used to measure the minimum comparative effort required to produce near full compaction of a soil, and the rate at which a sample of chalk lumps are crushed.

The unit can be used to classify chalk as a fill material with saturated moisture content.

The apparatus comprises a robust frame where a rammer falls, mould, scale, counter, accessories.

**Weight:** 60 kg approx.



S088-10

## LABORATORY SAMPLE MIXERS

Suitable to mix granular materials like soils and bituminous mixtures, by using a whisk beater, as prescribed by EN, BS Spec.

### MODELS

**E095+B028-03** MIXER, 5 LITRE CAPACITY, complete with whisk beater

**B027+B027-03** MIXER, 20 LITRE CAPACITY, complete with whisk beater

Technical details:  
see p. 90



E095 + B028-03

**S058**
**NUCLEAR MOISTURE DENSITY GAUGE**

STANDARDS: ASTM D6938, D2950, C1040 | AASHTO T310

This product is used to measure moisture density of the construction material from surface to 300 mm of depth. This device can measure and display wet density and dry density, percent moisture, moisture content and other necessary engineering parameters related to density and moisture content of materials.

Software features include self-test, special calibration, asphalt thinlayer mode and built in diagnostics tests to help users identify problems and solve them in the field.

Specifications:

- Density measurement range: 1120 to 2720 kg/m<sup>3</sup>
- Moisture measurement range: 0 to 640 kg/m<sup>3</sup>
- Precision at 2000 kg/m<sup>3</sup>, 150 mm - Depth:  $\pm 3.5$  kg/m<sup>3</sup>
- Moisture precision at 240 kg/m<sup>3</sup>:  $\pm 4.42$  kg/m<sup>3</sup>

**Gauge dimensions:** 580x310x220 mm

**Weight:** 14 kg approx.

**ACCESSORIES for S058**
**S058-11**

NUCLEAR GAUGE VALIDATOR AND CALIBRATION DEVICE

STANDARDS: ASTM D6938, D2950 | AASHTO T310

This lightweight block may be used in the field to check the calibration accuracy of the gauge and re-calibrate all model gauges, if necessary. The software for determination of calibration constant is user friendly and communicates directly with the gauge for download of constants. The block is constructed for the rugged construction industry with 1/8" Aluminum exterior with powder coat paint and it is internally lined with shielding and composite compound in secured enclosure.

For calibration, the user requires a PC with Windows® operating system.

**Dimensions:** 480x460x300 mm

**Weight:** 38 kg approx.

**S058-12** SOFTWARE to be used with the validator for calibrations.

**S058-11**

**S058**
**S060**
**NUCLEAR MOISTURE DENSITY GAUGE**

STANDARDS: ASTM D6938, D2950, C1040 | AASHTO T310

It provides a rapid method of on-site determination of moisture density content of soils, aggregates and asphaltic concrete. The microprocessor displays all functions directly.

Wet and dry density, moisture percent, moisture content, percent compaction for both soils and asphaltic concrete, void ratio and percent air voids.

Surce is 300 mm with index rods for direct transmission depths in 50 mm increments. Stores up to 320 field tests, transferable to PC or printer.

**Gage dimensions:** 400x220x140 mm

**Shipping weight:** 14 kg approx.

**S060**

## S059-10 ELECTRICAL DENSITY GAUGE

STANDARD: ASTM D7698

This Electrical Density Moisture Gauge is a “nuclear-free” alternative for determining the moisture and density of compacted soils used in road beds and foundations. This portable, battery powered unit is capable of being used anywhere without the concerns and regulations associated with nuclear safety. Its user-friendly step-by-step menu guides the user through each step of the testing procedure to established curves for the material being tested.

Easy-to-use the Gauge can be used as a construction aid to monitor day-to-day compaction operations by providing performance and measurement results highly comparable to those achieved with traditional methods, including the nuclear gauge and/or sand-cone and oven moisture test combination.

When conducting a test, the instrument measures and displays the results for wet and dry density, gravimetric moisture content and percent compaction.

Advantages:

- It does not require a highly-trained technician.
- It does not require special handling for shipping or the regulatory compliance for hazardous materials.
- It is easy-to-learn and easy-to-use with its step-by-step menu.
- Lightweight and easily transportable.
- It is accurate and repeatable with results that mirror known testing methods.
- Dry density accuracy: within 3% of standard tests.
- Moisture density accuracy: within 2% of standard tests.

The Gauge includes: Console/Case, 4-tapered 6” darts, hammer, soil sensor and cables, dart template, temperature probe, battery charger, field verifier, safety glasses.

**Dimensions:** 533x432x203 mm

**Shipping Weight:** 16 kg approx.



**S059-10**



## S059 GEOGAUGE-NON NUCLEAR GAUGE FOR SITE SOIL COMPACTION CONTROL

YOUNG MODULUS

STANDARD: ASTM D6758

**Technical features:**

Stiffness	3 to 70 MN/m
Young's Modulus	26 to 610 Mpa
Measure Depth	from 230 to 310 mm.
Measure Duration	75 seconds
Power	Six D-Cell Batteries (500 to 1500 measurements)

**Dimensions with case**

**Weight**

470x420x330 mm

15 kg



**S059**

This is the only hand portable gauge available to provide the required simplicity, quickness and precision to directly measure and monitor the in-place engineering properties and do so at construction speed. The device applies a constant load vibrating force to the soil's surface and measures the resulting displacement.

This dynamic technology simulates actual in-use conditions.

One instrument to link design specifications with compaction in 75 seconds for enhanced QC/QA.

Applications include subgrade, subbase, base monitoring the strength gain of lime, cement, fly-ash and polymer stabilised materials, monitoring the re-compacting of asphalt and cold in-place recycling to peak properties to prevent wasted effort and damaging over-compaction. The device compliments and provides alternative to resilient modulus, Falling Weight Deflectometer, field California Bearing Ratio, plate load test, dynamic cone penetrometer and other measures of strength, stiffness, modulus and deflection.

### ACCESSORIES

**S059-01** INFRARED INTERFACE AND SERIAL PORT ADAPTER with Software Template (PC only).

**S059-02** VERIFIER MASS (verifies the non nuclear gauge operation).

## S077N EARTH RESISTIVITY METER

STANDARDS: ASTM G57 | BS 1377:3

Used for ground water researches even to great depths, gravel deposit evaluation, geological surveys for the construction of roads, pipelines etc., study and prevention of landslides.

The system consists of:

- 1 earth resistivity meter with software (requires external pc, not included)
- 2 cable reels with 300 m cable
- 2 cable reels with 100 m cable
- 2 stainless steel electrodes
- 2 copper electrodes
- 2 1.25 kg mallet

**Dimensions:** 270x246x123 mm

**Weight:** 2.9 kg approx.



### ACCESSORY

#### S078-01N ENERGIZER, TWO PIECES

Energy source for geoelectrical surveys (in alternative to dry batteries or generators).

**Dimensions:** 27x24x10.5 cm (each piece)

**Weight:** 2.7 kg approx. (each piece)

## S079N SEISMOGRAPH, 24 CHANNELS

This new type of seismograph is a compact-sized and it has 24 channels, with a 24 bit data acquisition board and USB interface for external PC. Suitable for so many applications, this system is a really affordable solution for all professional uses.

Applications:

- Refraction
- Shallow reflection
- Surface waves (MASW, Re.Mi., Vs30, MAAM, ESAC, etc.)
- HVSr / Vibrations
- Downhole (with 3D borehole geophone)
- Crosshole (with 3D borehole geophone and cross-hole energizer for P/S waves Mod.CHE)

**Dimensions:** 24x19.5x11 cm

**Weight:** 2 kg approx.

### MAIN FEATURES

- 24 channels + trigger (AUX) – 2 units can be serialized for a total of 48 chs.
- 24 real bits, Sigma-Delta ADC
- To be connected to any portable PC/tablet PC/ Toughbook (not included)
- Power supply from USB (no external battery!)
- Standard NK2721C seismic cable connectors
- Compatible with analog geophones of any resonance frequency
- Free upgrades of data acquisition software
- PELI Case (IP67 when closed)



S079N



## S132N COLOR STANDARD GLASS SCALE

### ORGANIC IMPURITIES IN SOILS

STANDARDS: ASTM C40-11 method D | AASHTO T21

For the determination of the Organic impurities in soils and fine aggregates.

The chart has 5 glass reference scales.



**S132-01** GRADUATED IMPURITIES TEST BOTTLE, stoppered, pyrex glass, 500 ml - ASTM C40

**S132-02** GRADUATED IMPURITIES TEST BOTTLE, stoppered, pyrex glass, 500 ml, marked at 130 and 200 ml - UNI 8020-14

**S132-03** GRADUATED IMPURITIES TEST BOTTLE, stoppered, pyrex glass, 1000 ml - ASTM C40

**V300-24** SODIUM HYDROXIDE, pack of 1000 g

## S133N MUNSELL SOIL COLOUR CHART

Colour matching charts for soil identification.

The set consists of 7 constant hue charts with 196 colours, plus two tropical soil colour charts.



S133N

**S135** ACIDITY TEST KIT OF WATER to evaluate the potential corrosive. The set comprises different graduated containers, reagents, syringe, pipette, instructions.

**S136** CHLORIDE TEST KIT OF WATER. The set comprises different reagents, graduated containers, pipette, syringe, instructions.

**S137** HARDNESS TEST KIT OF WATER, for calcium and magnesium percentage determination. The set comprises different reagents and graduated containers, syringe, pipette, instructions.

**S137-01** ALKALINITY TEST KIT to determine the total alkalinity of water.

**S138** COMPACT LABORATORY FOR SOIL ANALYSIS Compact laboratory for the determination of nitrate-, nitrite-, and ammonium-nitrogen as well as pH in soils. Formed by different bottles, reagents and accessories to perform about 50 tests for each soil factor.



S137-01



S138



S135



S136



S137



## UNIVERSAL SAMPLE EXTRUDERS

STANDARDS: EN 13286-2, 13286-47 | ASTM D698, D1587, D1883 | BS 598, 1377:4, 1924:2

### S111 MOTORISED HYDRAULIC EXTRUDER

Used for a smooth and rapid extrusion of soil samples from tubes also of thin walls with minimum disturbance. The unit extrudes samples from Ø 35 up to 150 mm (external diameter 160 mm) with max. stroke of 900 mm.

The hydraulic piston is equipped of speed adjuster and can be stopped in any excursion's position.

Max. load: 70 kN (7000 kg)

The extruded sample is held in place by a receiving table adjustable in height and easily lowered along side the machine to save space.

Complete with adaptors (ring + tamper) to extrude samples having diameter 38.1 (1½"), 83, 100 mm.

**Power supply:** 230V 1ph 50Hz 1300W

**Dimensions (working position):** 2741x635x1200 mm

**Weight:** 160 kg approx.



S111

### S114 UNIVERSAL EXTRUDER

Used to extrude samples having diameter 4", 6", 100 mm, 150 mm. It can therefore extrude CBR, Marshall and Proctor specimens.

The extruder is actuated by a 50 kN hydraulic jack, having ram travel of 190 mm + 170 mm screw.

Supplied complete with adaptors

**Dimensions:** Ø 300x500 mm

**Weight:** 32 kg approx.



S114

### S114BT HAND-OPERATED HYDRAULIC EXTRUDER

Hand-operated hydraulic jack, 3 t capacity. Suitable for the extrusion of 4" and 100 mm diameter specimens from the mould.

**Dimensions:** 200x200x400 (h) mm.

**Weight:** 20 kg approx.



S114BT

### S112 SCREW EXTRUDER - HAND OPERATED

The unit extrudes samples from Ø 35 to 101.6 mm with max. stroke of 650 mm. Supplied complete with adaptors to extrude samples having diameter 38.1 (1½"), 83, 100 mm, supporting bench, sample receiving table both adjustable in height and lowerable.

**Dimensions:** 1700x700x1200 mm

**Weight:** 90 kg approx.



S112

ADAPTORS (ring and tamper) for S111 and S112 Extruders:

Code	Diameter
S113-10	38.1 mm ( 1 ½") (spare)
S113-11	50.8 mm (2")
S113-12	76.2 mm (3")
S113-13	101.6 mm (4")
S113-14	83 mm (spare)
S113-15	100 mm (spare)
S113-16	35 mm
S113-17	150 mm (only for mod. S111)

## S118 SOIL DIE CUTTER | SAMPLER

Used to compress loose soils to prepare samples, and to hollow punch (cut) and extrude soil specimens for consolidation, shear, triaxial, unconfined tests.

The sampler is used with the hollow punches S122 to S122-20 and tampers S123 to S123-16. Upper plate diameter is 120 mm and max. vertical daylight is 470 mm.

**Dimensions:** 500x300x900 mm

**Weight:** 30 kg approx.

## HOLLOW PUNCHES AND TAMPERS

Used to prepare soil samples and to fit them into the relevant cells to perform triaxial, consolidation, shear, unconfined tests.

The punch has thin walls with cutting rim, and the tamper expels the specimen from the hollow punch by inserting it directly into the cell without disturbing the same.

Cell	Dimensions	Height	Hollow Punch	Tamper
Consolidation	Ø 50.47	20 mm	<b>S122</b>	<b>S123</b>
Consolidation	Ø 63.50	20 mm	<b>S122-19</b>	<b>S123-05</b>
Consolidation	Ø 71.40	20 mm	<b>S122-01</b>	<b>S123-01</b>
Consolidation	Ø 75.00	20 mm	<b>S122-17</b>	<b>S123-04</b>
Consolidation	Ø 79.80	20 mm	<b>S122-02</b>	<b>S123-02</b>
Consolidation	Ø 112.80	25 mm	<b>S122-03</b>	<b>S123-03</b>
Consolid. Permeab.	Ø 50.47	20 mm	<b>S122-04</b>	<b>S123</b>
Consolid. Permeab.	Ø 63.50	20 mm	<b>S122-20</b>	<b>S123-05</b>
Consolid. Permeab.	Ø 71.40	20 mm	<b>S122-05</b>	<b>S123-01</b>
Consolid. Permeab.	Ø 75.00	20 mm	<b>S122-18</b>	<b>S123-04</b>
Consolid. Permeab.	Ø 79.80	20 mm	<b>S122-06</b>	<b>S123-02</b>
Consolid. Permeab.	Ø 112.80	25 mm	<b>S122-07</b>	<b>S123-03</b>
Shear	Ø 50	23 mm	<b>S122-08</b>	<b>S123-08</b>
Shear	Ø 60	23 mm	<b>S122-09</b>	<b>S123-09</b>
Shear	Ø 63.5	23 mm	<b>S122-21</b>	<b>S123-17</b>
Shear	Ø 100	23 mm	<b>S122-10</b>	<b>S123-10</b>
Shear	∇ 60x60	23 mm	<b>S122-11</b>	<b>S123-11</b>
Shear	∇ 100x100	23 mm	<b>S122-12</b>	<b>S123-12</b>
Triaxial + Unconf.	Ø 38	76 mm	<b>S122-13</b>	<b>S123-13</b>
Triaxial	Ø 50	100 mm	<b>S122-14</b>	<b>S123-14</b>
Triaxial	Ø 70	140 mm	<b>S122-15</b>	<b>S123-15</b>
Triaxial	Ø 100	200 mm	<b>S122-16</b>	<b>S123-16</b>



**V113**

**V112-01** PORCELAIN MORTAR Ø 125 by 65 mm complete with porcelain pestle.

**V113** PESTLE, rubber headed.

**S124** WIRE SAW for trimming soil specimens. Complete with six blades.

**S125** TRIMMING KNIFE to prepare samples.



**S124**

**S125**



**S118** with punches and tampers

## S120 SOIL LATHE

Designed to reduce by trimming the diameter of a soil sample until reaching the desired diameter size by using a wire saw. The lathe is hand-operated, the height is adjustable up to 230 mm, and it accepts samples from Ø 38 to 110 mm.

Supplied complete with three sets of platens for samples Ø 38-50, 47-60 mm, wire saw and 6 blades.

**Dimensions:** Ø 460x720 mm

**Weight:** 20 kg approx.



**S120**

## ACCESSORY

**S120-01** UPPER TRIMMING PLATEN available from Ø 38 to 110 mm. When ordering please specify required diameter.

**S140**  
**ION EXCHANGE DEVICE**
**SULPHATE CONTENT DETERMINATION**  
 STANDARD: BS 1377:3

This device is used to know the sulphate content of ground water and water soil extracts.

Consisting of a ion exchange glass tube 400 mm long, connector and bottom flask 500 ml capacity. The unit is assembled on a stand.

**Dimensions:** 190x110x600 mm  
**Weight:** 5 kg approx.



S140

V300-30

**ACCESSORY**
**V300-30** Ion exchange resin, 500 g

**CHLORIDE CONTENT, RAPID METHOD**

STANDARDS: BS 812:117 | BS 1377:3

Used to estimate the chloride content of aqueous solutions in sand and fine aggregates.

**A019-01** QUANTAB Chloride Titrator Strips, type 1175, range 0.005% to 0.1% (30 to 600 ppm) Na Cl. Pack fo 40 strips.

**A019-02** QUANTAB Chloride Titrator Strips, type 1176, range 0+05% to 1% (300 to 6000 ppm) Na Cl. Pack of 40 strips.

**SULPHATE CONTENT, RAPID METHOD**

STANDARD: BS 1377:3

Used to determine the sulphate ions in aqueous solutions of sand and fine aggregates.

**A019-03** SULPHATE TEST STRIPS, detection range 200 to 1600 mg/l. Pack of 100 strips.



A019-01

A019-02

A019-03

**B073-01**  
**MAGNETIC STIRRER/HEATER**

For titration and stirring of liquid and semi-solid materials. Plate Ø 150 mm.

Variable speed and temperature by electronic regulators.

Supplied complete with magnetic teflon coated follower.

**Power supply:**  
 230V 1ph 50-60Hz 700W



B073-01

**pH METERS, DIGITAL**

STANDARDS: ASTM D1067 | BS 1377:3

**V215**  
**pH METER, POCKET**

Battery operated, with replaceable electrode

Range: 0.00 to 14.00 pH - Resolution 0.01 pH  
 Manual 2 points calibration.

Power supply: standard battery, 3000 hours use.  
 Supplied complete with: electrode, batteries, 5+5 kit of pH 4 and 7 calibration solutions

**Weight:** 70 g



V215

**V215-01N**  
**pH/mV/°C METER, PORTABLE, WATERPROOF**

Range pH: 0.00 to 14.00 - Resolut. 0.01 pH

mV: ± 1999 - Resolut. 0.1mV - 1mV

Temperature: 0 to 100°C

Manual 2 points calibration.

Automatic temperature compensation.

Power supply: 9V battery, 100 hours use.

Supplied complete with: electrode, temperature probe, battery, calibration solutions, case.

**Weight:** 180 g



V215-01N

 **Note:** Complete range of pH meters at p. 599

**A028****UNIVERSAL CARBIDE METER**

STANDARDS: BS 6576 | AASHTO T217 | ASTM D4944

For the rapid and accurate determination of moisture content in soil sand, gravel, aggregates etc, based on the calcium carbide method. It is possible to vary the sample weight from 3 to 100 g achieving a moisture range 50% (3g) - 7.5% (20g) - 1.5% (100g).

The bottle is calibrated and equipped with a surface thermometer. The glass ampoule containing the calcium carbide is broken when the bottle is closed and shaken, granting better accuracy to the test. The instrument comprises the testing bottle with manometer, small balance, 25 ampoules of reagent, accessories, case.

**Dimensions:** 520x340x140 mm**Weight:** 6 kg approx.**A028**

 **Note:** Other carbide meter models: see p. 29

**SPARE****A028-11** Carbide Ampoules (pack of 100)**A028-11****V023-01****MOISTURE DETERMINATION BALANCE**

160 g capacity x 0.001/0.01 g sensitivity with tare up to 10 g. Samples are dried by a infrared lamp with adjustable heat control. A built-in-timer 0-61 min. switches off the heater at the end of the drying cycle which is signaled by a bell. Moisture loss percentage and residual mass are read directly from the lighted scale.

**Power supply:** 230V 1ph 50-60Hz**V023-01****A117 + A116-11 + A116-12 + C279-02****A117****END-OVER-END SHAKER**

PARTICLE DENSITY OF SOILS

STANDARD: BS 1377:2

Used to determine the particle density of soils containing up to 10% of particles retained on a 37.5 mm sieve.

It rotates two gas jars at approx. 50 rpm to satisfy BS Standard. The shaker is equipped with an original friction device conforming the unit to CE Safety Directive.

Supplied **without** gas jars to be ordered separately

**Power supply:** 230V 50Hz 1ph 150W**Dimensions:** 550x430x500 mm**Weight:** 20 kg approx.**A116-11****A116-12****ACCESSORIES**

**A116-11** GAS JAR to determine the specific gravity of soils. Complete with glass cover. Diameter 75 mm by 300 mm height  
**Weight:** 1.3 kg

**A116-12** RUBBER BUNG for the gas jar A116-11

**C279-02** SEPARATE CONTROL PANEL, complete with ON/OFF switch, timer, fuse, electric protections.

**S155 KIT**  
**PARTICLE SIZE ANALYSIS OF SOILS**
**HYDROMETER METHOD**

STANDARDS: ASTM D422 / AASHTO T88

This complete set is used to determine the quantitative size distribution of very fine particle in soils such as clay and silt.

- S155 KIT** The complete set comprises:
- S155-01** Hydrometer jar, 1000 ml capacity (6 pieces provided with the kit)
- V172** Soil hydrometer, 151H, range 0.995 to 1.038 g/ml with div. 0.001
- S155-04** Glass tank, dimensions: 600x300x380 mm
- S155-09** Heater, **professional type**, complete with thermostat, cooling coil, water circulating unit. 230V 1ph 50-60Hz 1000W
- S155-10** Thermometer, range 0 - 50 °C, subdiv. 0.5 °C.
- V104-03** Beaker, pyrex, 250 ml capacity
- V300-23** Sodium Hexametaphosphate, 1000 g
- S156-01 KIT** High speed stirrer, 10.000 rpm, complete with cup, paddle, anti-splash baffle, for dispersing soil particles in water. 230V 1ph 50-60Hz

**Total weight:** 60 kg approx.

ALTERNATIVE:

**S155S KIT**  
**PARTICLE SIZE ANALYSIS OF SOIL**

Same as S155 KIT but:

- S155-09S** HEATER **simple type**, complete with thermostat and water circulating unit but without cooling coil
- NEW** (see accessories S155-08). 230V 1ph 50-60Hz

**S155-09S**

**S155 KIT**
**ACCESSORIES**

- V172-02** SOIL HYDROMETER 152H, range -5 to 60 g/l (alternative to mod. V172)
- S155-02** BUNG, rubber, for the cylinder S155-01
- S155-08** COOLING COIL for S155-09S
- S155-11** NOMOGRAPHIC CHART, for stoke's law determination.
- S156** STIRRER, manual, for cylinders 1000 ml capacity mod. S155-01
- C306-03** SEPARATE CONTROL PANEL, complete with on/off switch and electric protections, to get S155-09 heater to CE Safety Directive.

**C306-03**
**ACCESSORIES according to NF P94-057 Standard**

- S155-03** HYDROMETER JAR, 2500 ml capacity, 85 ± 5 mm Ø, graduated at 500, 1500, 2000 ml.
- S156-03** STIRRER MANUAL, 600 mm long for cylinders 2500 ml capacity, mod. S155-03.
- V172-03** SOIL HYDROMETER 0.995 to 1030 g/ml.

**SPARES for S156-01 KIT Stirrer**

- S156-11** Anti-splash baffle
- S156-12** Paddle
- S156-13** Cup (beaker)

**S156-13**
**S156-12**
**S156-11**

**S156-01 KIT**
**S156-03**
**S156**

## S143 KIT PARTICLE SIZE DISTRIBUTION PIPETTE METHOD

STANDARD: BS 1377:2

This equipment is used to determine the quantitative size distribution of very fine particle in soils, like clay and silt.

The complete set comprises:

- S144** Andreasen pipette, 25 ml capacity, for an accurate extraction of the quantities of soil in suspension for analysis.
  - S144-01** Pipette stand, to accurately raise and lower the pipette with no transmission of vibration to not disturb the sample suspension. Weight: 10 kg
  - S144-02** Sedimentation cylinder, 500 ml capacity
  - S144-03** Rubber bung for cylinder
  - S144-04** Evaporating dish, glass, Ø 90 by 50 mm height.
  - V172-03** Soil hydrometer, long stem, 0.995 to 1030 g/ml.
  - S155-04** Glass tank, dimensions: 600x300x380 mm.
  - S155-09** Heater, **professional type**, complete with thermostat, cooling coil, circulation unit.  
Alternative: S155-09S simple type, see p. 474
  - S155-10** Thermometer, range 0 - 50 °C, subd. 0.5 °C.
- Total weight:** 40 kg approx.

 **Note:** each item can be ordered separately.

### ACCESSORIES

- S144-10** ANDREASEN PIPETTE, capacity: 10 ml
- C306-03** CONTROL PANEL, complete with on/off switch and electric protections, to get S155-09 heater to CE Safety Directive.
- A117** END-OVER-END SHAKER. Technical details: see p. 60



## S157 KIT METHYLENE BLUE TEST SET

CLAY CONTENT IN FINE AGGREGATES

STANDARDS: EN 933-9 | NF P94-068 | UNI 8520-15 | UNE 83180

Utilized to determine the clay content in the fine portions of aggregates. The set comprises:

- S157-01** Electric stirrer adjustable from 400 to 700 rpm, complete with Ø 70 mm propeller. 230V 1ph 50-60Hz
- S157-06** Support base for stirrer
- S157-02** Burette 50 x 0.1 ml with stopcock
- S157-07** Support base for burette
- S157-08** Pan 200x150x80 mm
- S157-03** Filter paper Ø 90 mm (pack of 100)
- S157-04** Glass rod Ø 8x300 mm
- S157-05** 2000 ml capacity plastic beaker
- V300-28** Methylene blue, 100 g
- V300-29** Kaolinite, 500 g

**Total Weight:** 10 kg approx.

 **Note:** each item can be ordered separately.

- S157-10** AUTOMATIC DISPENSER, 0-10 ml x 0.1 ml grad. Capacity 1000 ml (alternative to S157-02+S157-07)



## S157-20 AUTOMATIC METHYLENE BLUE TESTER

This instrument determines automatically the quantity of clay in sand. It grants accurate and repeatable test results, saving a lot of time (approx. 30 minutes each test). The apparatus is composed of: precision pump, colorimeter, control unit, filters, accessories. To perform the test S157-01, S157-06, V300-28 and V300-29 devices are also needed.

**Power supply:** 230V 1ph 50Hz  
**Dimensions:** 300x400x350 mm  
**Weight:** 10 kg approx.



**S157-20**

**S158 KIT**  
**SAND EQUIVALENT TEST SET**

STANDARDS: ASTM D2419 | AASHTO T176

This complete set comprises:

- S158-01N** Plexiglass measuring cylinder engraved at 100 and 380 mm, with transparent adhesive label, graduated in mm and inch (5 pieces)
  - S158-02** Rubber stopper for cylinder (2 pieces)
  - V176-02** Graduated rule 500 mm, stainless steel
  - V136-01** Funnel, wide mouth
  - S158-04N** Measuring can 85 ml capacity
  - V121** Plastic bottle, 5 litre capacity
  - S158-06** Irrigator tube with stopcock and syphon assembly
  - S158-07N** Weighted foot assembly for sand level
  - A052-44** Sieve, Ø 200 mm, opening 4.75 mm
  - S158-09** Concentrated stock solution, 1000 ml
  - V170** Stop watch, digital
  - S158-11** Clamp stand set to hold the syphon assembly with bottle
  - S158-12** Portable carrying case, dimensions: 550x250x400 mm
- Total Weight:** 18 kg approx.

**S158 KIT**
**S158-20 KIT**  
**SAND EQUIVALENT TEST SET**

 STANDARDS: EN 933-8 | NF XP18-598 | CNR N.27  
 UNI 8520-15 | UNE 83131

This complete set comprises:

- S158-03N** Plexiglass measuring cylinder engraved at 100 and 380 mm (5 pieces)
  - S158-02** Rubber stopper for cylinder (2 pieces)
  - V176-02** Graduated rule 500 mm, stainless steel
  - V136-01** Funnel, wide mouth
  - S158-05** Measuring can 200 ml capacity
  - V121** Plastic bottle, 5 litre capacity
  - S158-10** Irrigator tube with stopcock and syphon assembly
  - S158-13** Weighted foot assembly for sand level
  - A052-37** Sieve, Ø 200 mm, opening 2 mm
  - S158-09** Concentrated stock solution, 1000 ml
  - V170** Stop watch, digital
  - S158-11** Clamp stand set to hold the syphon assembly with bottle
  - S158-12** Portable carrying case, dimensions: 550x250x400 mm
- Total Weight:** 18 kg approx.

**S158-20 KIT**
**ACCESSORY**

- S158-08** METALLIC FUNNEL, conforming to EN 933-8 / NF XP18-598 UNI 8520/15 Specifications.

**S158-08**

 **Note:** each item can be ordered separately.

## S159 KIT SAND EQUIVALENT TEST SET (SIMPLE)

STANDARDS: ASTM D2419 | AASHTO T176

The set comprises:

- S158-01N** Plexiglass measuring cylinder engraved at 100 and 380 mm, with transparent adhesive label, graduated in mm and inch (4 pieces)
- S158-02** Rubber stopper for cylinder (2 pieces)
- V176-02** Graduated rule 500 mm, stainless steel
- V136-01** Funnel, wide mouth
- S158-04N** Measuring can 85 ml capacity
- V121** Plastic bottle 5 litre capacity
- S158-06** Irrigator tube with stopcock and syphon assembly
- S158-07N** Weighted foot assembly for sand level
- S158-09** Concentrated stock solution, 1000 ml

**Total Weight:** 5 kg approx.



S159-11

S159 KIT

### ACCESSORY

- S159-11** CARRING CASE, PLASTIC, housing the sand equivalent set mod. S159 KIT or S159-01 KIT except the bottle V121

### MEASURING CYLINDERS

Available Models :

#### S158-01N

STANDARDS: ASTM D2419 | AASHTO T176

PLEXIGLASS MEASURING CYLINDER, engraved at 100 and 380 mm, with transparent adhesive label graduated in mm and inches.

AS ALTERNATIVE:

#### S158-01GN

STANDARDS: ASTM D2419 | AASHTO T176

PLEXIGLASS MEASURING CYLINDER, engraved at 100 and 380 mm with additional **engraved scale from 0 to 380 mm**

#### S158-03N

STANDARDS: EN 933-8 | NF XP18-598

PLEXIGLASS MEASURING CYLINDER, engraved at 100 and 380 mm

## S159-01 KIT SAND EQUIVALENT TEST SET (SIMPLE)

STANDARDS: EN 933-8 | NF XP18-598 | UNI 8520-15  
CNR N.27 | UNE 83131

The set comprises:

- S158-03N** Plexiglass measuring cylinder engraved at 100 and 380 mm (4 pieces)
- S158-02** Rubber stopper for cylinder (2 pieces)
- V176-02** Graduated rule 500 mm, stainless steel
- V136-01** Funnel, wide mouth
- S158-05** Measuring can 200 ml capacity
- V121** Plastic bottle 5 litre capacity
- S158-10** Irrigator tube with stopcock and syphon assembly
- S158-13** Weighted foot assembly for sand level
- S158-09** Concentrated stock solution, 1000 ml

**Total Weight:** 5 kg approx.



S159-11

S159-01 KIT

### ACCESSORY

- S158-08** METALLIC FUNNEL, conforming to EN 933-8 | NF XP18-598 | UNI 8520/15 Specifications.



S158-03N S158-01GN S158-01N



S158-08

 **Note:** each item can be ordered separately.



### S160N MOTORIZED SAND EQUIVALENT SHAKER

STANDARDS: EN 933-8 | ASTM D2419 | AASHTO T176  
 NF XP18-598 | UNE 83131 | CNR N.27  
 UNI 8520-15

The unit provides a constant uniform shaking with automatic cycle test. Oscillating excursion is 203 mm at 175...180 adjustable strokes/min. rate. Complete with digital timer that automatically stops the shaker at the end of the test. It cannot be sold in CE markets without security cabinet (see model S160-01N)

**Power supply:** 230V 1ph 50Hz 250W

**Dimensions:** 700x360x350 mm

**Weight:** 30 kg approx.



**S160N + S158-03N + S158-02**

### S160-01N MOTORIZED SAND EQUIVALENT SHAKER

Same as S160N, but equipped with steel Security Cabinet, conforming to CE Safety Directive. When opening cabinet's door during shaker working, a microswitch automatically stops the machine.



**S160-01N + S158-03N + S158-02**

### S161 SAND EQUIVALENT SHAKER HAND OPERATED

STANDARDS: EN 933-8 | ASTM D2419 | NF XP18-598  
 AASHTO T176 | UNI 8520-15 | UNE 83131

Hand operated working through handwheel.  
 Complete with mechanical strokes counter.

**Dimensions:** 700x350x420 mm approx.

**Weight:** 20 kg approx.



**S161**

### ASSESSMENT OF FINES: GRADING OF FILLERS

STANDARD: EN 933-10

### A058-05N AIR JET SIEVE SHAKER

Suitable for sieving powder and dry grain products up to 5 microns.

Technical details: see p. 38



**A058-05N**

## SPECIFIC GRAVITY OF SOILS

E136

### WATER BATH, DIGITAL

STANDARD: BS 1377:2

For the determination of particle density, pycnometer method, according to BS 1377:2 Specifications, and for general laboratory purposes.

All stainless steel made, with wool insulation and water circulation electric stirrer, the bath ensures an uniform and constant temperature. Complete with digital thermostat and dual safety thermostat with higher thermic threshold ensuring safe working conditions.

A cooling device to be connected to the water net is used when room temperature exceeds the requested one.

Capacity: 40 litres

Temperature range: ambient to 60 °C, accuracy  $\pm 0.5$  °C

**Internal dimensions:** 510x350x230 mm

**Overall dimensions:** 680x420x420 mm

**Power supply:** 230V 1ph 50Hz 1200W

**Weight:** 28 kg approx.



E136

## SPECIFIC GRAVITY BOTTLE, GAY LUSSAC TYPE

STANDARDS: BS 1377:2 | ASTM D854 | AASHTO T100  
NF P18-054, NF P94-054

Pyrex glass made, complete with capillary tube stopper, these bottles are used to determine the specific gravity and density of fine soils and filler in fine aggregates.

Models	Capacity
V108	25 ml
V108-01	50 ml
V108-02	100 ml
V108-03	250 ml



V108-01

V108-02

## DESICCATORS BOROSILICATE GLASS

Complete with perforated porcelain plate.

Without vacuum		With vacuum	
A035	Ø 200 mm	A039	Ø 200 mm
A036	Ø 250 mm	A040	Ø 250 mm
A036-01	Ø 300 mm	A040-01	Ø 300 mm

## ACCESSORY

V300-15 DESICCATORS SALTS Silica gel box 1000 g



A039

A035

V202

### ASPIRATOR PUMP

To be connected to the water net with a minimum pressure of 0.7 kg/cmq, it produces a moderate vacuum pressure.

**Weight:** 100 g



V202

S147

### CONE PYCNOMETER

STANDARDS: EN 1097-6 | BS 1377:2

Used for the determination of specific gravity and water absorption of sands and fine aggregates.

Glass jar with aluminium cone and rubber seal.

Capacity: 1 kg



S147

S148

### SAND ABSORPTION CONE AND TAMPER

STANDARDS: EN 1097-6 | BS 812

Used to determine the specific gravity and water absorption of fine aggregates.

**Weight:** 500 g approx.



S148



## LIQUID LIMIT CASAGRANDE METHOD

Used to evaluate the relationship between the moisture percentage of a soil sample and the number of blows required to close a groove made into the soil and therefore to determine when a clay soil changes from a plastic to a liquid state.

The unit comprises a removable brass cup which through a cam device drops on a bakelite base (or hard rubber base). Supplied complete with drops counter, but **without grooving tool** which has to be ordered separately.

The instrument is available in two versions:

- hand operated through crank (left or right side)
- motor operated at 120 drops/min speed, ensuring better uniformity and accuracy

### MODELS

#### S170

##### LIQUID LIMIT DEVICE

Hand operated with **left side crank** and hard rubber base.

STANDARDS: ASTM D4318 | AASHTO T89 | UNI 10014  
comparable to: BS 1377:2 | UNE 7377

**Weight:** 3 kg approx.

#### S170-05

##### LIQUID LIMIT DEVICE

Hand operated.

Same as mod. S170, but with **right side crank**.

#### S170-01

##### LIQUID LIMIT DEVICE

Hand operated with bakelite base, chromed cup.

STANDARD: NF P94-051-1

#### S172

##### LIQUID LIMIT DEVICE

Motor operated with hard rubber base.

STANDARDS: ASTM D4318 | AASHTO T89 | UNI 10014  
comparable to: BS 1377:2 | UNE 7377

**Power supply:** 230V 1ph 50Hz

**Weight:** 4.5 kg approx.

#### S172-01

##### LIQUID LIMIT DEVICE

STANDARD: NF P94-051

Motor operated with bakelite base, chromed cup.

**Power supply:** 230V 1ph 50Hz

### ACCESSORIES

- S173-02** ROUGH BRASS CUP, with central smooth band 10 mm wide, as requested by NF P94-051 Standard, used for soils having low plasticity
- S173-03** GROOVING TOOL, to UNI 10014 - AASHTO T89 Spec.
- S173-04** GROOVING TOOL, to ASTM D 4318 Specifications
- S173-05** GROOVING TOOL, to NF P94-051-1 Specifications
- S173-06** GROOVING TOOL, to BS 1377:2 Specification



**S173-01...S173-08**

### SPARES

- S173-01** Brass cup. (ASTM, BS, UNI, UNE, AASHTO).
- S173-07** Chromed cup (NF P94-051-1).
- S173-08** Coupling piece between cup and device, hand operated models.
- S173-09** Coupling piece between cup and device, motor operated models.

## S175 SHRINKAGE LIMIT

STANDARDS: ASTM D 427 | AASHTO T 92 | UNI 10014  
UNE 103-108 | NF XP94-060-1 | BS 1377:2

Used to determine the maximum moisture content at which the soil does not shrink after drying the sample.

Complete with carrying case.

The set comprises:

- V122-04** Shrinkage dish, Ø 45x12,7 mm (2 pieces)
- V122-03** Crystallizing dish, Ø 57x32 mm
- S175-03** Shrinkage prong plate, made from plexiglass material with three metal prongs
- S175-04** Glass evaporating dish, Ø 120 mm flat bottom
- V100-01** Graduated cylinder 25 ml capacity
- V192** Flexible spatula, 100 mm blade

**Case dimensions:** 390x300x100 mm

**Weight:** 2 kg approx.

 **Note:** each item can be ordered separately.



**S175**



**S176**

## S176 LINEAR SHRINKAGE

STANDARD: BS 1377:2

Mould to produce a specimen of 140 mm long x 12.5 mm radius. This test covers the determination of linear shrinkage of soils and indicates the plastic properties of soils with a low clay content.

**Weight:** 500 g approx.



**S178**

## S178 PLASTIC LIMIT

STANDARDS: ASTM D4318 | AASHTO T90 | BS 1377:2  
UNI 10014 | UNE 103-104 | NF P94-051

The plastic limit determines the lowest moisture content of a soil, by which a sample can be rolled into threads Ø 3 mm without breaking the same neither longitudinally or transversely.

The set complete with carrying case comprises:

- S178-01** Glass plate 300x250x10 mm
- S178-02** Rod caliper Ø 3 mm
- V114-03** Mixing porcelain dish Ø 120 mm
- V192** Flexible spatula, 100 mm blade
- V122** Aluminium moisture tins Ø 55x35 mm (Q.ty 6)

**Case dimensions:** 400x340x100 mm

**Weight:** 5 kg approx.

 **Note:** each item can be ordered separately.

### ACCESSORIES

**S178-06** GLASS PLATE 105x50 mm graduated each 10 mm with brass spacer 5 mm to measure the diameter of the soil sample to 3 mm ± 0.5 according to NF P94-051

**S179** GLASS PLATE 500x500x10 mm

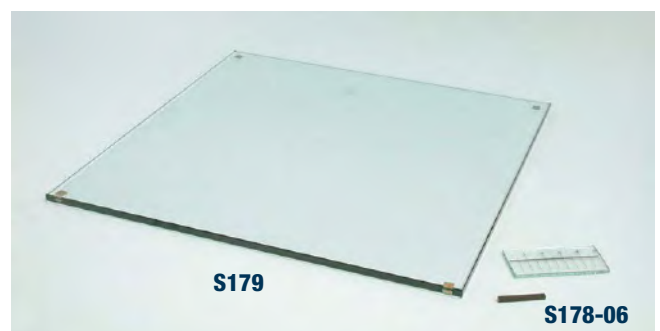

**S179**

**S178-06**

## CONE PENETROMETER METHOD FOR:

### LIQUID LIMIT DETERMINATION

STANDARDS: CEN ISO/TS 17892-12 | BS 1377:2 | NF P94-052-1

The test is based on the relationship between the moisture content at which clay soils pass from a plastic to a liquid state.

This value is obtained from the penetration capacity of the standard cone allowed to free fall into the sample for a period of 5 seconds.

### SHEAR STRENGTH DETERMINATION

STANDARD: CEN ISO/TS 17892-06

The cone penetrometer is also suitable to measure the shear undrained strength of undisturbed and reconstituted soil samples as per CEN ISO/TS 17892-06 Standard.

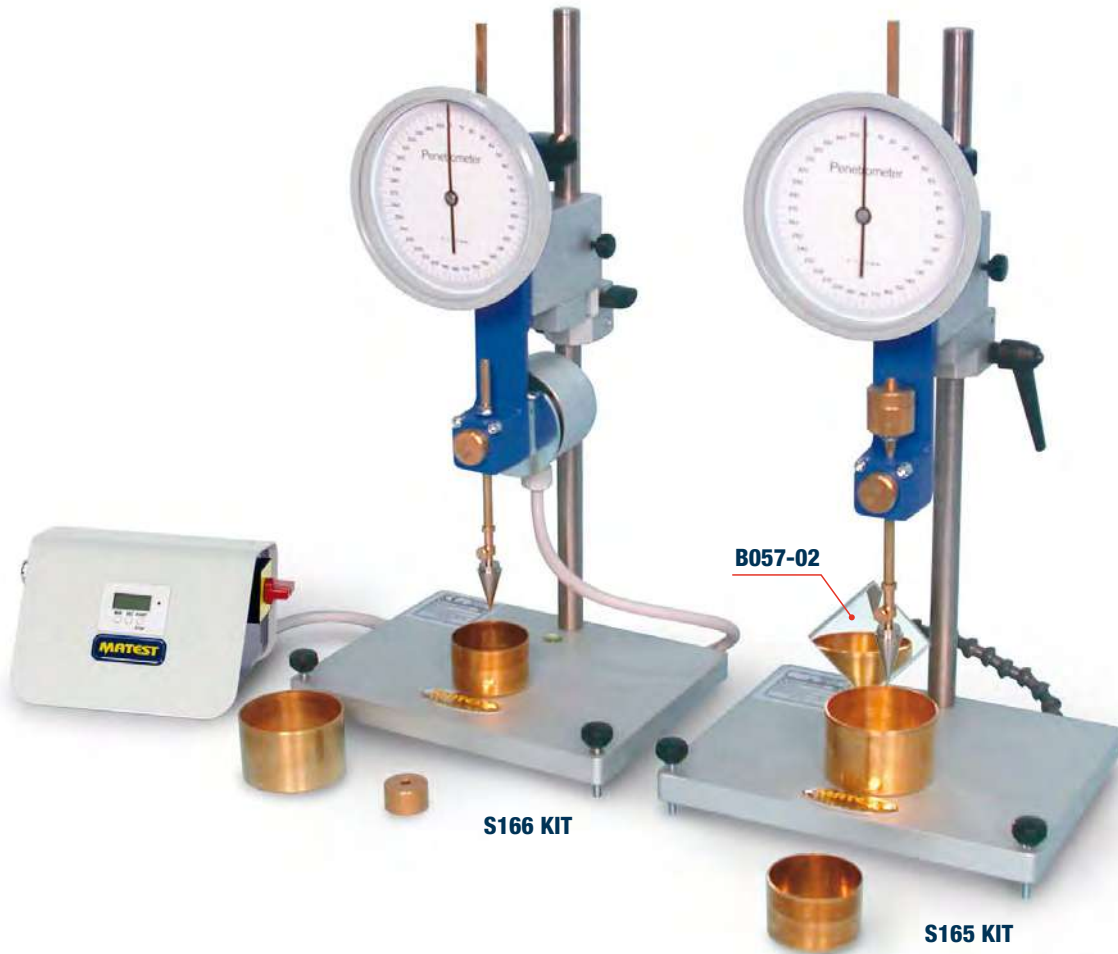

## MODELS

### S165 KIT CONE DIAL PENETROMETER

The cone penetrometer consists of:

- Aluminium base with levelling screws and spirit level.
- Chromed vertical rod with **micrometric vertical displacement device**.
- Dial gauge 150 mm diameter, graduated in 360°, division 0.1 mm
- Slider, brass made, with free fall, stop and release push button, automatic zero set.
- Stainless steel penetration test cone 35 mm long, 30° angle
- Weight 20 g
- Two brass cups Ø 55x35 mm and 70x45 mm

**Dimensions:** 220x170x410 mm

**Weight:** 13 kg approx.

### S166 KIT SEMIAUTOMATIC CONE DIAL PENETROMETER

Basically structured as mod. S165KIT, but equipped with a magnetic controller device with electronic digital programmable timer that automatically releases the plunger head and ensures free falling of the cone during the 5-seconds test.

Supplied complete.

**Power supply:** 230V 1ph 50-60Hz 200W

**Dimensions:** 220x280x410 mm

**Weight:** 15 kg approx.

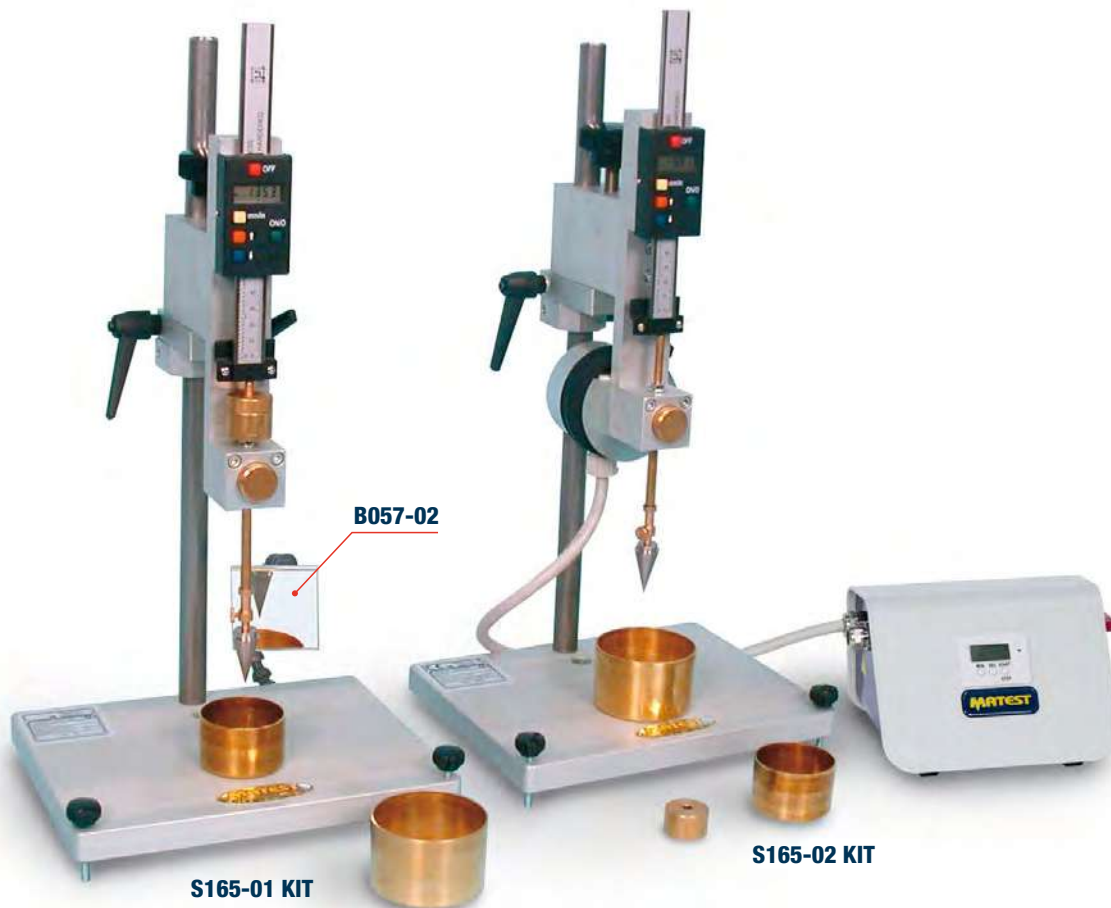

### S165-01 KIT CONE DIGITAL PENETROMETER

The cone penetrometer consists of:

- Aluminium base with levelling screws and spirit level.
- Chromed vertical rod with **micrometric vertical displacement device**.
- Digital readout of the penetration values.
- Readings in mm and inch, with 0.1 mm resolution. LCD 5 digits display, with zero set in any position.  
Power: 1.5V battery.
- Slider, brass made, with free fall, stop and release push button, automatic zero set.
- Stainless steel penetration test cone 35 mm long, 30° angle.
- Weight 20 g
- Two brass cups Ø 55x35 mm and 70x45 mm

**Dimensions:** 220x170x410 mm

**Weight:** 13 kg approx.

### S165-02 KIT SEMI-AUTOMATIC CONE DIGITAL PENETROMETER

Basically structured as mod. S165-01 KIT, but equipped with a magnetic controller device with electronic digital programmable timer that automatically releases the plunger head and ensures free falling of the cone during the 5-seconds test.

Supplied complete.

**Power supply:** 230V 1ph 50-60Hz 200W

**Dimensions:** 220x280x410 mm

**Weight:** 15 kg approx.

#### ACCESSORIES for S165 KIT, S166 KIT, S165-01 KIT, S165-02 KIT

- S166-03** TEST GAUGE, to check the condition of the cone point 30° angle.
- B057-02** MIRROR, to facilitate the height adjustment of the cone.
- S166-04** TEST CONE 60° angle and 60 g weight (liquid limit and shear strength tests).
- S166-05** TEST GAUGE, to check the condition of the cone point 60° angle.
- S166-06** WEIGHT, 320g to be added to the cone 30° angle, to get a total weight of 400 g (shear strength test).
- V122-08** SAMPLE CUP, aluminum, Ø 55 mm by 40 mm deep, to meet BS 1377:2 Specification

#### SPARES for S165 KIT, S166 KIT, S165-01 KIT, S165-02 KIT

- S166-01** Test cone 35 mm long and 30° angle.
- S166-02** Weight 20 g to be added to the cone 30° angle, to get a total weight of 100 g
- V122-05** Brass cup Ø 55x35 mm
- V122-06** Brass cup Ø 70x45 mm







## PROCTOR TEST MOISTURE-DENSITY RELATIONSHIP

STANDARDS: EN 13286-2 | ASTM D558, D698, D1557 | AASHTO T99, T134, T180 | BS 1377:4, 1924:2  
 CNR N° 69 | NF P94-078, P94-093, P98-231-1 | DIN 18127

### PROCTOR MOULDS

Used for determining the relationship between the moisture content and density of compacted soils. Steel made, complete with mould body, collar and base; plated against corrosion. Different proctor mould models are available according to the various international Standards in use.

Models	Description Proctor Mould	Standards	Int. diameter mm	Body height mm	Volume ml	Weight kg
<b>S185</b>	Standard	ASTM   AASHTO   NF   CNR	101.6	116.4	944	4.5
<b>S186</b>	Modified	ASTM   AASHTO   CNR	152.4	116.4	2124	10
<b>S189</b>	Split Standard	ASTM   AASHTO   NF   CNR	101.6	116.4	944	5
<b>S190</b>	Split Modified	ASTM   AASHTO   CNR	152.4	116.4	2124	10
<b>S190-01</b>	Modified	NF	152	152	2758	10
<b>S191</b>	Standard	BS	105	115.5	1000	5
<b>S194</b> 	Standard	EN 13286:2 comparable to DIN	100 ± 1	120 ± 1	942	9
<b>S194-01</b> 	Modified	EN 13286:2 comparable to DIN	150 ± 1	120 ± 1	2120	13
<b>S194-03</b> 	Split Standard	EN 13286:2 comparable to DIN	100 ± 1	120 ± 1	942	7.5
<b>S194-04</b> 	Split Modified	EN 13286:2 comparable to DIN	150 ± 1	120 ± 1	2120	12.5
<b>S194-02</b>	Large Size	EN 13286:2 comparable to DIN	250 ± 1	200 ± 1	9817	32

#### Note:

Annex "A" of EN 13286-2:2010 (E) Standard, allows alternative moulds such as: S185, S186, S189, S190, S190-01, S191, that have cheaper prices. It is intended that these alternatives will be deleted at the next EN revision.



## PROCTOR RAMMERS

Used to compact the soil sample into the mould. The spherical hand knob is from bakelite with metal screw and protection ring nut; guide sleeve with vent holes. The rammers are steel made, plated against corrosion, available in different models according to the various International Standards in use. In alternative to the rammers the automatic compactor mod. S199 (see p. 486) can be used.

Models	Description	Standards	Diameter mm	Fall height mm	Rammer weight kg	Total weight kg
<b>S187</b>	Standard Proctor rammer	ASTM   AASHTO CNR   NF	50.8	304.8	2.495	5
<b>S187-01</b>	Standard Proctor rammer	EN 13286:2 comparable to BS	50 ± 0.5	305 ± 3	2.5 ± 0.02	5
<b>S188</b>	Modified Proctor rammer	ASTM   AASHTO CNR   NF	50.8	457.2	4.536	8
<b>S188-01</b>	Modified Proctor rammer	EN 13286:2 comparable to BS	50 ± 0.5	457 ± 3	4.5 ± 0.04	8
<b>S188-02</b>	Proctor rammer Large Size	EN 13286:2	125 ± 0.5	600 ± 3	15 ± 0.04	23

## STEEL PLATE (COMPACTION DISK)

STANDARDS: EN 13286:2 | DIN 18127

Used to compact the EN moulds, it is supplied complete with T handle, plated against corrosion.

### MODELS

#### S194-09

PLATE, Ø 99.5 mm thickness 10 mm

#### S194-10

PLATE, Ø 149.5 mm thickness 10 mm

#### S194-11

PLATE, Ø 249.5 mm thickness 20 mm



S188-01



S188-02

## CUTTING COLLAR

Coupled to the Proctor mould body, it gets easier the soil sampling

### MODELS

**S185-01** Diameter 4"

**S200-09** Diameter 6"



#### S114

UNIVERSAL EXTRUDER for moulds Ø 100, 150 mm; 4", 6"  
Technical details at p. 470





## S199 AUTOMATIC, PROGRAMMABLE PROCTOR | CBR COMPACTOR WITH MICROPROCESSOR HIGH PERFORMANCE

STANDARDS: EN 13286-47 | ASTM D698, D1557, D1883  
 AASHTO T99, T180, T193 | BS 1377:4, 1990, 1994  
 NF P94-093, P94-066 | DIN 18127  
 UNE 7365, 7255, 103-501-94 | CNR UNI 10009  
 CNR N. 29, 69 | DUTCH RAW | AS 1289 and most  
 International Standards.

Designed to compact Proctor and CBR specimens, it ensures an extremely uniform compaction degree, granting reliable and repeatable test results.

The microprocessor software allows to select and perform different compaction cycles in a fully automatic system, by strictly meeting the mentioned International Standards.

The blows are automatically distributed as requested by the selected Standard, with turntable rotation and rammer displacement through photoelectric cell sensors and microprocessor. Top quality components and high accuracy mechanical workings grant very long life also under intensive utilisations.

The digital control panel is separate from the machine and it can be fixed to the wall or mounted on a bench.

The high resolution graphic display (blue negative) 320x240 pixels visualizes selected Standard, total number of blows, effected and remaining ones to end the test, and execution of each layer.

The compactor is easy to use, friendly menu driven, versatile, of simple and practical maintenance.

The user can **select and memorize up to 10 personalized test cycles**, that can be later on modified or replaced by other ones. This is a very important function, because it allows to update the Compactor to new Standards, or any Standard not included in the microprocessor, or for research purposes.

The original lift system of the rammer can be selected at 12" or 18", or at 300 or 450 mm, granting a correct and constant fall height. Rammer drop speed: 1 blow each 2 seconds.

The compactor accepts moulds having  $\varnothing$  4" and 6", 100 and 150 mm, both Matest made or from other producers, thanks to its universal mould fixing system.

The machine is supplied **without rammers** to be ordered separately and selected according to the desired Standard (rammers are interchangeable).

Not sellable in CE markets

(see accessory: safety guards mod S199-11)

**Power supply:** 230V 1ph 50Hz 500W

**Dimensions:** 610x470xh1710 mm

**Weight:** 200 kg approx.



**S199 with mould  
 and rammer**

### NEEDED ACCESSORIES

**S199-06** STANDARD RAMMER  $\varnothing$  50  $\pm$  0.2 mm  
 and 2500  $\pm$  10 g weight

**S199-07** MODIFIED RAMMER  $\varnothing$  50  $\pm$  0.2 mm  
 and 4535  $\pm$  5 g weight

Modified rammer are hardened for wear resistance.

Conforming to: EN 13286-47 | BS 1377:4 | DIN 18127

UNE 7255, 7365, 103-501-94 Standards.

OR:

**S199-08** STANDARD RAMMER  $\varnothing$  50.8  $\pm$  0.13 mm  
 and 2491,25  $\pm$  1.25 g weight

**S199-09** MODIFIED RAMMER  $\varnothing$  50.8  $\pm$  0.13 mm  
 and 4537  $\pm$  3 g weight

Modified rammer are hardened for wear resistance.

Conforming to: ASTM D558, D559, D698, D1557, D1883

NF P94-066/93 | CNR UNI 10009

CNR N. 69 | ASHTO T99, T180, T193

OR:

**S199-13** STANDARD RAMMER,  $\varnothing$  50  $\pm$  0.4 mm  
 and 2700  $\pm$  10 g weight

**S199-14** MODIFIED RAMMER,  $\varnothing$  50  $\pm$  0.4 mm  
 and 4900  $\pm$  10 g weight

Modified rammer are hardened for wear resistance.

Conforming to: AS 1289 (Australian) Standard.

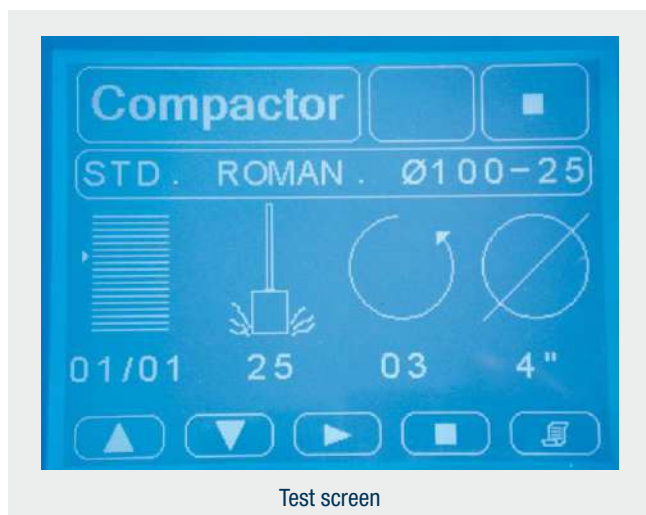

Test screen

## ACCESSORIES

**S199-11** SAFETY GUARDS to CE Directive.  
If the door is opened when the Compactor is working, it stops automatically.

As alternative:

**S199-12** SOUNDPROOF SECURITY CABINET, steel made with microswitch, complying to CE Safety Directive, lined with sound-proofing material for noise reduction. If the door is opened while the Compactor is working, it automatically stops.

**Dimensions:** 740x730x1900 mm

**Weight:** 80 kg approx.

## SPARES

**S198-22** Calibrated rod holding the rammer.

**S198-23** Kit of two devices fixing the mould to the table.



S199 + S199-12 with accessories

## S199TS AUTOMATIC PROCTOR | CBR COMPACTOR

### TECNOTEST MODEL

STANDARDS: EN 13286-2 | ASTM D698, D1557, D1883 | CNR N. 69,  
CNR UNI 10009 | AASHTO T99, T180, T193

A selector switch enables the operator to choose type of compaction required (circular blow pattern for 4" or 100mm specimen moulds and double concentric circles for 6" or 150 mm specimen moulds). Height of rammer drop adjustable to 305 mm or 457 mm.

The number of blows is preset on the electronic microprocessor-based control panel. The machine is designed for long-term operation and has built-in safety features (to CE Standards) to prevent it from being operated without the unbreakable safety guard.

Thanks to its compact height design, the compactor is recommended for mobile laboratories. Complete **without rammer**, to be ordered separately according to the selected standard.

**Power supply:** 230V 1ph 50Hz

**Dimensions:** 1760x590x400 mm

**Weight:** 220 kg approx.

## NEEDED ACCESSORY

**S199T-03** RAMMER Ø 50 mm with interchangeable weight from 2500 ± 20g to 4500 ± 40g.  
STANDARD: EN 13286-2

Or:

**S199T-04** RAMMER Ø 50.8 mm with interchangeable weight from 2495 ± 3g to 4539 ± 5g.  
STANDARDS: ASTM D698, D1557, D1883 | CNR N. 69,  
CNR UNI 10009 | AASHTO T99, T180, T193



S199TS + S199T-03

**CALIFORNIA BEARING RATIO - CBR**

STANDARDS: EN 13286-47 | EN 13286-4 | ASTM D1883 | AASHTO T193 | CNR UNI 10009 | UNE 103-502  
NF P94-078, P94-093, P98-231-1 | BS 1377:4, 1924:2

This method has been developed by the California State Highway Department, and is now accepted by almost all the International Standards in force. The test is aimed to the evaluation of the bearing capacity of soil for flexible pavement design in road construction. The compaction test can be performed both with the manual rammers and the automatic compactor mod. S199.



**S201-05**



**S200...** CBR SET TO ASTM, AASHTO, CNR/UNI, UNE STANDARDS



**S200-04F**

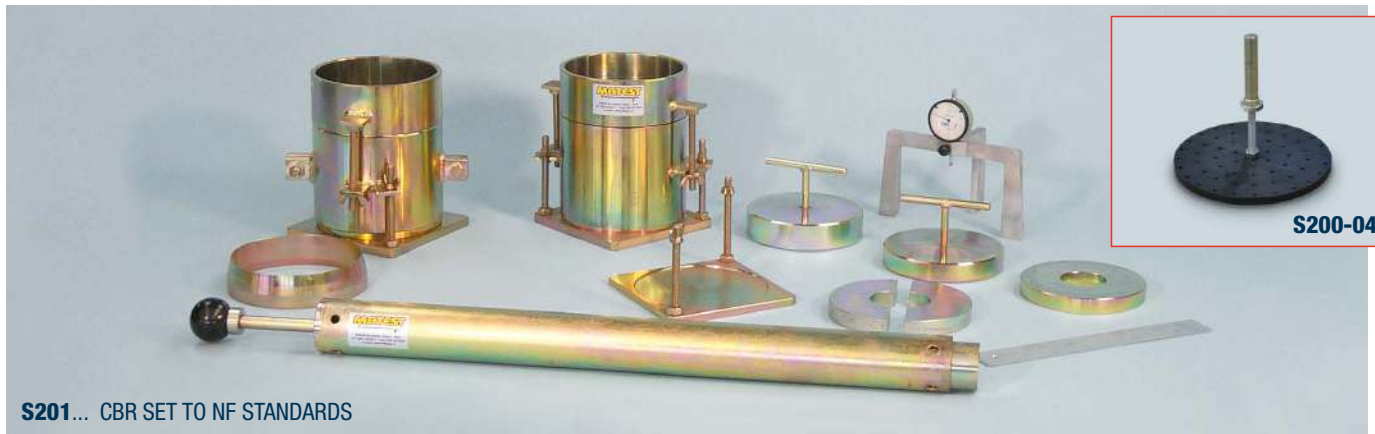

**S201...** CBR SET TO NF STANDARDS

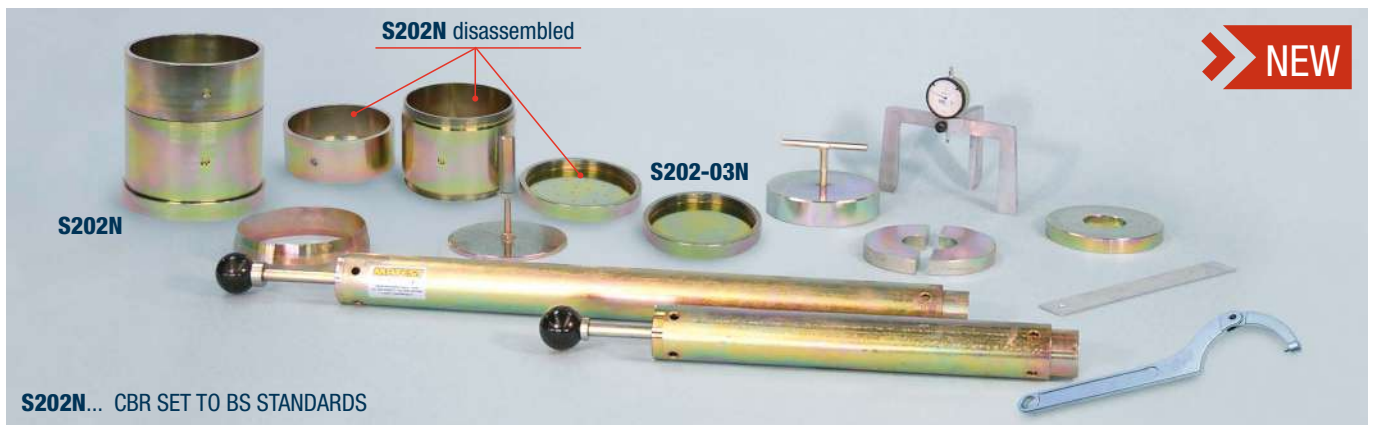

**NEW**

**S202N** disassembled

**S202-03N**

**S202N**

**S202N...** CBR SET TO BS STANDARDS



**S203...** CBR SET TO EN 13286-47 STANDARD

The CBR equipment, steel made and plated against corrosion is available in different versions according to the various Standards in force.



**S114**

Description	Standards			
CALIFORNIA BEARING RATIO	ASTM D1883	EN	NF P94-078	BS 1377:4
Ordering info	CNR UNI 1009	13286-47	NF P94-093	BS 1924:2
	UNE 103-502		NFP98-231-1	
	AASHTO T193			
CBR mould complete with collar and perforated base:				
Ø 6" (152.4 mm) x 7" (177.8 mm) height	S200-01N			
Ø. 150 mm x 120 mm height		S203		
Ø 152 mm x 152 mm height			S201	
Ø 152 mm x 127 mm height, threaded ends				S202N 
Split CBR mould with collar and perforated base:				
Ø 6" (152.4 mm) x 7" (177.8 mm) height	S200-13N			
Ø 150 mm x 120 mm height		S203-01		
Ø 152 mm x 152 mm height			S201-01	
Solid base plate for CBR mould	S200-12N	S194-15	S201-12	S202-03N
Perforated base plate for CBR mould	S200-10N	S194-14	S201-10	S202-10N
"C" Spanner, to tighten/loosen the collar, body and base. Two required				S202-04
Filter screen, stainless steel Ø 149 mm mesh 0.150 mm (ASTM n° 100)	S200-02	S200-02	S200-02	S200-02
Spacer disc with "T" handle:				
Ø 5 15/16" (150.8 mm) x 2.416" (61.4 mm) height	S200-03			
Ø 149.5 mm x 36 mm height		S194-21		
Ø 151 mm x 25.4 mm height			S201-02	
Ø 151 mm x 36 mm height			S201-06	
Ø 150 mm x 50 mm height				S202-07
Perforated (sweel) plate with adjustable stem	S200-04	S194-23	S200-04F	S200-04
Plein swell plate		S194-24		
Tripod (dial gauge support)	S200-05	S194-26	S200-05	S200-05
Dial gauge 10 mm range, 0.01 mm subd.	S376	S376		
Dial gauge 25 mm range, 0.01 mm subd.			S377	S377
Annular surcharge weight 2270 g	S200-07			
Annular surcharge weight 2300 g			S200-07	
Annular surcharge weight 2000 g		S202-08		S202-08
Slotted surcharge weight 2270 g	S200-08			
Split surcharge weight 2300 g			S201-04	
Split surcharge weight 2000 g		S202-09		S202-09
Cutting edge	S200-09		S200-09	S200-09
Compaction rammer:				
Ø 50.8 mm fall height 457.2 mm, weight 4.54 kg.	S188			
Ø 50 mm fall height 457.2 mm, weight 4.54 kg.		S188-01	S188	S188-01
Straight edge 300x30x3 mm	S200-11	S200-11	S200-11	S200-11
Straight edge, cutting rim, 300x30x3 mm	S200-06	S200-06	S200-06	S200-06
Filter paper Ø 150 mm (pack of 100)	S200-14	S200-14	S200-14	S200-14
Soaking tank 600x400x400 mm	S201-05	S201-05	S201-05	S201-05
Universal extruder (see p. 470)	S114	S114	S114	S114

## S196N CLEGG HAMMER - IMPACT SOIL TEST

STANDARD: ASTM D5874-02

High quality genuine Clegg Impact Soil Tester manufactured under license to Dr. Clegg Pty Ltd (the original inventors).

This apparatus is used to obtain an indication of the degree of compaction of soil. Recorded values can be directly correlated to the CBR test method. User can quickly enable/disable the readout unit to calculate the 4th drop %CBR following Dr. Clegg's revised and updated equation with inter-drop CIV check TREND algorithm.

### MAIN FEATURES

- Well-proven and stable components.
- Easy to use, no set-up is required.
- Back lit highly readable alpha numeric display.
- Optionally fitted Bluetooth with PC Software to allow data transfer of CIV, %CBR, time and data of up to 10000 drop tests.

Lightweight and sturdy aluminum framed transit and storage case is provided.

**Dimensions:** 710x130x130 mm

**Weight:** 6.2 kg approx.

## S197N1 VIBRATING COMPACTION HAMMER

STANDARDS: EN 12697-9, 12697-10, 12697-32, 13286-4  
BS 1377:4 | BS 1924:2

It provides an alternative method for the compaction of soil samples in the determination of dry density/moisture content relation (called Proctor), unconfined compressive strength of stabilized soils and CBR tests. This hammer is also used for the compaction of asphalt in the percentage refusal density (see p. 97) and for compacting concrete cube or beam samples.

Supplied without tampers and support frame which must be ordered separately.

**Power supply:** 230V 1ph 50-60Hz 720W

**Dimensions:** 105x430x270 mm

**Weight:** 6 kg approx.

### ACCESSORIES

**S197-01N** SUPPORTING FRAME for vibrating hammer.  
The sliding mass has a total weight (including hammer and tamping foot) of 37 kg as requested by EN Spec. Steel made, plated against corrosion.

**Dimensions:** 500x320x1100 mm

**Weight:** 75 kg approx.

**B097-11N** SMALL TAMPING FOOT, 102 mm diameter.  
Complete with shank.

**B097-12N** CBR AND PROCTOR LARGE TAMPING FOOT,  
146 mm diameter. Complete with shank.



S196N

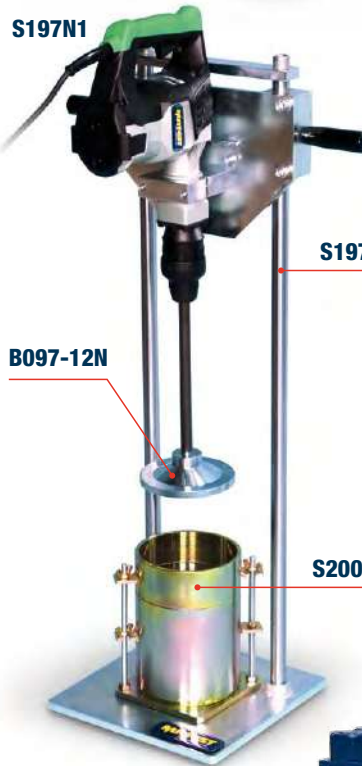

S197N1

S197-01N

B097-12N

B097-12N

B097-11N

S200-01N



COMPRESSIVE STRENGTH OF UNBOUND, HYDRAULICALLY BOUND AND SOIL-CEMENT MIXTURES

STANDARDS: EN 13286-41, EN 12390-4

A compression machine with suitable measuring range (0-250/500 kN) is used for compression tests on soil-cement cylindrical mixture specimens. The cement (see p. 418...423) or concrete (see p. 230...251) machines are suitable to perform this test.

## STRENGTH OF STABILIZED SOIL DETERMINATION

STANDARDS: EN 13286-53 | NF P94-100 | NF P98-230-2 | BS 1924 :2

Used to prepare specimens bound with cementitious binders or aggregate mixes for determination of the Unconfined compressive strength of fine and medium grained soils. Made of plated steel.

### MODELS

- |                |   |                |  |
|----------------|---|----------------|--|
| <b>S195-01</b> | Mould Ø 50 by 122 mm to obtain specimen dia. 50x50 mm high of fine and medium grained soil (NF)                         | <b>S195-22</b> | Collecting cylinder Ø 106 by 210 mm            |
| <b>S195-02</b> | Mould Ø 50 by 172 mm to obtain specimen dia. 50x100 mm high of fine and medium (EN, BS) and of coarse grained soil (NF) | <b>S195-11</b> | Set of 2 displacing collars Ø 50 by 5 mm       |
| <b>S195-15</b> | Mould Ø 100 by 242 mm to obtain specimen dia. 100x100 mm high of coarse grained soil (EN, BS)                           | <b>S195-06</b> | Set of 2 displacing collars Ø 50 by 6 mm       |
| <b>S195-20</b> | Mould Ø 100 by 342 mm to obtain specimen diameter 100x200 mm high of coarse grained soil (EN, BS)                       | <b>S195-12</b> | Set of 2 displacing collars Ø 50 by 8.33 mm    |
| <b>S195-03</b> | Base and upper piston Ø 50 by 36 mm   | <b>S195-23</b> | Set of 2 displacing collars Ø 50 by 10 mm      |
| <b>S195-16</b> | Base and upper piston Ø 100 by 71 mm  | <b>S195-07</b> | Set of 2 displacing collars Ø 50 by 12.5 mm    |
| <b>S195-04</b> | Penetration and demoulding piston Ø 50 by 125 mm  | <b>S195-24</b> | Set of 2 displacing collars Ø 50 by 16.66 mm   |
| <b>S195-05</b> | Penetration and demoulding piston Ø 50 by 175 mm  | <b>S195-08</b> | Set of 2 displacing collars Ø 50 by 25 mm      |
| <b>S195-17</b> | Penetration and demoulding piston Ø 100 by 245 mm   | <b>S195-13</b> | Set of 2 displacing collars Ø 100 by 10 mm     |
| <b>S195-21</b> | Penetration and demoulding piston Ø 100 by 345 mm   | <b>S195-14</b> | Set of 2 displacing collars Ø 100 by 16.66 mm  |
| <b>S195-09</b> | Collecting cylinder Ø 56 by 60 mm   | <b>S195-25</b> | Set of 2 displacing collars Ø 100 by 20 mm     |
| <b>S195-10</b> | Collecting cylinder Ø 56 by 110 mm  | <b>S195-19</b> | Set of 2 displacing collars Ø 100 by 25 mm     |
| <b>S195-18</b> | Collecting cylinder Ø 106 by 110 mm   | <b>S195-27</b> | Set of 12 displacing collars Ø 100 by 33.33 mm |
|                |   | <b>S195-28</b> | Set of 2 displacing collars Ø 100 by 50 mm     |



S195-01...S195-28

### S131 KIT UNCONFINED COMPRESSION TESTER

STANDARDS: ASTM D2166 | AASHTO T208 | BS 1377:7

This hand-operated tester, utilized both on site and in laboratory, applies the load by a handwheel and strength is read on a proving ring 200 kg. capacity.

The apparatus can test samples up to Ø 80 mm x 200 mm height.

The S131KIT tester comprises:

- S221** Conversion frame
- S221-01** Mechanical jack 50 kN capacity
- S370-02** Load ring 2 kN capacity
- S131-11** Upper+lower compression platens with accessories
- S376** Dial gauge 10x0.01 mm
- S212-03** Dial gauge holder

**Dimensions:** 380x460x1380 mm

**Weight:** 68 kg approx.



**S131 KIT**

### S220 KIT FIELD CBR TEST SET

STANDARDS: BS 1377:9, 1924:2 | ASTM D4429  
CNR UNI 10009

Used to determine quickly and efficiently the bearing capacity of soils on road constructions, foundations, road subgrades etc.

The S220 KIT tester comprises:

- S221-01** Mechanical jack 50 kN capacity
- S370-09** Load ring 40 kN capacity
- S212-01** CBR penetration piston
- S377** Dial gauge 25x0.01 mm
- S212-03** Dial gauge holder
- S220-01** Datum bar 1400 mm long; slotted surcharge weights 4.5 and 9 kg and annular 4.5 kg; set of extension rods: 2x100 mm, 1x300, 600, 1000 mm; accessories; wooden carrying case.

**Weight:** 70 kg approx.



**S220 KIT**

### S210 KIT CBR LOADING MACHINE

HAND OPERATED, FIELD MODEL

STANDARDS: EN 13286-47 | ASTM D1883 | AASHTO T193  
BS 1377:4 | NF P94-078 | CNR UNI 10009

The load is applied through a mechanical jack with handwheel. The upper beam can be adjusted in height.

The S210KIT machine comprises:

- S221** Conversion frame
- S221-01** Mechanical jack 50 kN capacity
- S370-10** Load ring 50 kN capacity
- S212-01** CBR penetration piston
- S376** Dial gauge 10x0.01 mm
- S212-03** Dial gauge holder

**Dimensions:** 420x370x1180 mm

**Weight:** 65 kg approx.



**S210 KIT**

#### Note:

The machines described in this page include some common component (like for ex. the mechanical jack mod. S221-01). It is therefore possible to combine these components for different machines, with some economical advantage.

## CALIFORNIA BEARING RATIO TESTING MACHINES - CBR

STANDARDS: EN 13286-47 | ASTM D1883 | BS 1377-4 | AASHTO T193 | CNR UNI 10009 | NF P94-078

Used to load the penetration piston into the soil sample at a constant rate of 1.27 mm/min, and to measure the applied loads and piston's penetrations at determined intervals.

Matest proposes a wide range of machines: hand operated, motorized, dual speed, universal multispeed; load measurement by load ring, or by electric load cell and digital unit with X/Y graphic recorder of load/penetration through RS 232 port to PC.

### S209 KIT CBR LOADING MACHINE

HAND OPERATED, LABORATORY MODEL

Load is applied through a meckanical jack and handwheel.

Upper beam can be adjusted in height.

Foreseen of fast approach device of the base plate.

The S209KIT CBR machine comprises:

**S209-01** CBR laboratory frame

**S212-01** CBR penetration piston

**S370-10** Load ring 50 kN capacity

**S376** Dial gauge 10x0.01 mm

**S212-03** Dial gauge holder

**Dimensions:** 430x380x1180 mm

**Weight:** 80 kg approx.



**S209 KIT**

### S211 KIT CBR LOADING MACHINE, 50 KN MOTORIZED SPEED RATE: 1.27 MM/MIN

Load is applied through a screw jack driven by an electric motor at a constant penetration rate of 1.27 mm/min (ASTM, BS, EN Spec.)

achieved by a built in gear box and **assured also under load.**

Upper beam can be adjusted in height.

Foreseen of fast approach device of the base plate and electric end of stroke switches of the load plate to save the machine from wrong manipulations.

The S211KIT CBR machine comprises:

**S211-10** CBR motorized frame

**S212-01** CBR penetration piston

**S370-10** Load ring 50 kN capacity

**S376** Dial gauge 10x0.01 mm

**S212-03** Dial gauge holder

**Power supply:** 230V 1ph 50Hz 750W

**Dimensions:** 430x380x1180 mm

**Weight:** 98 kg approx.



**S211 KIT**

## ACCESSORIES

### S210-02 CBR RATE INDICATOR

Used to apply the correct rate of 1.27 mm/min penetration to hand operated CBR machine S209 KIT.

**Power supply:** 230V 1ph 50Hz



**S210-02**

**S374** BRAKE DEVICE, it holds the max. applied load on the dial gauge of the load ring, with manual zero setting. Suitable for S209 KIT and S211 KIT machines.

**S374-01** ELECTRIC DEVICE FOR AUTOMATIC STOP of the CBR machine when reaching the max. capacity load. To prevent any overload damage this device is mounted on the proving ring of the S211 KIT machine.



## S212M UNIVERSAL MULTISPEED LOAD FRAME 50 KN DIGITAL, TOUCH-SCREEN

This motorized machine with electronic digital touch-screen controlled by microprocessor, is suitable to perform all the tests where the requested speed rate is within:

**0.05 to 63 mm/min** with max. load of 50 kN

It can therefore perform:

- Unconfined test with rate of 0.635 mm/min.
- CBR test with rate of 1.27 and 1 mm/min.
- Marshall test with rate of 50.8 mm/min.
- Splitting tensile test on Marshall specimens.
- Quick Triaxial (with triaxial cell and suitable accessories)

The speed rate is infinitely variable, easily and promptly selected.

Display LCD TFT, 800x480 pixel, 7", touch-screen.

Time/date and language selection (English, French, German, Spanish, Italian, Polish).

Symbols of pushbuttons functions.

Foreseen of electric end of stroke switch of the load plate to save the machine from wrong manipulations.

Upper beam can be adjusted in height.

Supplied **without** load ring and accessories which have to be ordered separately.

**Power supply:** 230V 1ph 50-60Hz 750W

**Dimensions:** 480x450x1400 mm

**Weight:** 140 kg approx.



**S212M** with accessories for CBR test

## S213-05N CBR/MARSHALL 3 SPEEDS FRAME 50 KN

The frame is provided of three fix speed ranges, easily selectable by a frequency changer (inverter) activated by an electric switch:

**1.00 mm/min. for CBR tests** (Australian and old BS Standards)

**1.27 mm/min. for CBR tests**

**50.8 mm/min for Marshall tests.**

Upper beam can be adjusted in height.

Foreseen of electric end of stroke switch of the load plate to save the machine from wrong manipulations.

Supplied **without** load ring and accessories which have to be ordered separately.

**Power supply:**

230V 1ph 50-60Hz 750W

**Dimensions:**

450x400x1200 mm

**Weight:** 130 kg approx.



**S213-05N**  
with accessories for CBR test

### ACCESSORIES for S212M and S213-05N frames

#### CBR test

**S212-01** Penetration piston

**S370-10S** Load ring 50kN with electric stop safety device

**S374** Brake device to hold max. load

**S376** Dial gauge 10x0.01 mm

**S212-03** Dial gauge holder

#### MARSHALL test

**S212-05** Load piston

**B046N** Stability mould

**B047** Flow meter

**B047-01** Dial gauge for flow meter

**S370-08S** Load ring 30kN with electric stop safety device

**S374** Brake device to hold max. load (only for S212M model)

#### UNCONFINED test

**S212-08N** Upper + lower compression plates,  $\varnothing$  100 mm  
+ distance piece with rod

As Alternative

**S212-09N** Upper + lower compression plates,  $\varnothing$  165 mm  
with upper seat ball

**S212-03** Dial gauge holder

**S376** Dial gauge 10x0.01 mm

**S370-02S** Load ring 2kN with electric stop safety device

**S374** Brake device to hold max. load

## MULTIFUNCTION TESTING FRAMES

■ CBR

■ THREE SPEEDS

■ UNIVERSAL MULTISPEED

COMBINED WITH "CYBER-PLUS EVOLUTION", COMPUTERIZED TOUCH-SCREEN DIGITAL DISPLAY SYSTEM

### TECHNICAL SPECIFICATIONS

The frame is the same as for the previous load frames (mod. S211 KIT to S213-05N), but the load is measured by an electric 50kN cell with high precision strain transducers. The deformation (flow) is measured by a displacement transducer 50 mm stroke and  $\pm 0.1\%$  independent linearity.

The "CYBER-PLUS EVOLUTION" computerized multichannel digital display system (technical details: see mod. B044N-SET at p. 498, Hardware technical details at p. 18), measures and displays at the same time the load (stability) in kN and the deformation (flow) in mm with pick hold features and possibility to print certificates and graphics directly on a laser printer via USB or to transfer them to PC via Ethernet.

### AVAILABLE MODELS

#### S216 KIT CBR DIGITAL COMPUTERIZED MACHINE

SPEED RATE: 1.27 mm/min

Technical details of the frame: see mod. S211 KIT, p. 493

SUPPLIED COMPLETE except the software (see next page mod. S218N).



S216 KIT + CBR mould

#### S214-05N KIT CBR/MARSHALL 3 SPEEDS LOAD FRAME DIGITAL, COMPUTERIZED

The frame is provided of three fix speed ranges, easily selectable by an electric switch:

**1.00 mm/min. for CBR tests** (Australian and old BS Standards)

**1.27 mm/min. for CBR tests**

**50.8 mm/min for Marshall tests.**

Technical details of the frame: see mod. S213-05N, p. 494

Supplied complete with "Cyber-Plus Evolution" system, load cell and displacement transducer, but **without** accessories and Software for CBR and Marshall tests, to be ordered separately (see accessories at next page).



S214-05N KIT + MARSHALL accessories

## S215A UNIVERSAL MULTISPEED LOAD FRAME DIGITAL, TOUCH-SCREEN, COMPUTERIZED

Comprising:

**S212N** Universal multispeed load frame 50 kN, touch-screen. Technical spec.: see p. 494

**S212A** Acquisition and data processing system up to 8 analogical/digital channels for load cells and transducers. Graphic and numbers visualization, processing and printing of the test results.  
 Technical spec.: see B044N Cyber-plus 8 Evolution Touch-Screen, next page.

**S337-34** Load Cell 50 kN capacity, complete with cable and connector.

**S336-14** Linear Displacement Transducer 50 mm stroke, complete with cable and connector.

**S305-05** Mounting device of the coupling pliers.

**S335-15** Coupling pliers to hold the transducer.

Supplied **without** accessories for CBR, Marshall, Unconfined tests and Software, to be ordered separately (see accessories).

The Universal Multispeed tester, is the ideal solution to perform the following tests :

- CBR (California Bearing Ratio)
- UNCONFINED COMPRESSION
- QUICK TRIAXIAL
- MARSHALL



Detail of 8 channels



S215A with CBR mould



S215A with CBR mould

#### ACCESSORIES for the 3 speeds and the multispeed load frames, mod. S214-05N KIT and S215A to perform

##### CBR tests

**S212-01** PENETRATION PISTON

##### MARSHALL tests

**S212-05** LOAD PISTON

**B046N** STABILITY MOULD, cast aluminium alloy

##### UNCONFINED test

**S212-08N** UPPER + LOWER COMPRESSION PLATES,  
Ø 100 mm + distance piece with rod

As Alternative

**S212-09N** Upper + lower compression plates, Ø 165 mm  
with upper seat ball

##### QUICK TRIAXIAL TEST (only with S215A frame + suitable accessories)

**S337-31** STRAIN LOAD CELL 2.5 kN capacity

**S205-11** LOADING PISTON WITH BALL

**S305** TRIAXIAL CELL + accessories

**S218-02N** SOFTWARE for quick triaxial test

STANDARDS: ASTM D2850 | BS 1377

#### SOFTWARES for the frames combined with "Cyber-Plus Evolution" System

**S218N** SOFTWARE UTM2 Licence for **CBR** Test  
STANDARDS: EN 13286-47 | CNR UNI 10009 | ASTM D1883  
BS 1377 | NF P94-078 | AASHTO T193

**S218-01N** SOFTWARE UTM2 Licence for **UNCONFINED** test  
STANDARDS: ASTM D2166

**B043-01N** SOFTWARE UTM2 Licence for **MARSHALL** test  
STANDARDS: EN 12697-34 | ASTM D1559, D5581, D6927

**B043-02N** SOFTWARE UTM2 Licence for **TENSILE SPLITTING** test  
STANDARDS: EN 12697-23 | ASTM D6931

Description and technical details of Software UTM2: see p. 18

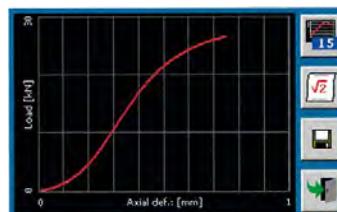

## B044N-SET CYBER-PLUS 8 EVOLUTION TOUCH-SCREEN

Developed for the implementation and upgrading of any type of existing machines (even not manufactured by Matest) applicable to:

- Marshall mechanical load frame mod. B042 KIT.
- CBR/Marshall 3 speeds load frame mod. S213-05N.
- CBR loading machine motorized mod. S211 KIT.

Suitable to perform the following tests:

- MARSHALL: EN 12697-34 | ASTM D6927, D5581, D1559, CNR N. 30 | NF P98-251-2 | BS 598 :107 AASHTO T245
- INDIRECT TENSILE TEST: EN 12697-23, EN 12697-12 ASTM D6931, D4123 | AASHTO T283
- DETERMINATION OF THE WATER SENSIBILITY OF BITUMINOUS SPECIMENS: EN 12697-12
- CBR TEST: EN 13286-47 | CNR | UNI 10009 | AASHTO T193 ASTM D1883 | BS 1377:4 | NF P94-078.
- UNCONFINED TEST: ASTM D2166

### MAIN FEATURES

- Acquisition and data processing system up to 8 analogical/digital channels.
- Remote control through PC and UTM2 software.
- Graphic display 1/4 VGA color Touch-Screen.
- Instant display of load and deformation.
- Automatic correction of the axis origin and automatic calculation of all the results.
- Safety switch-off at max reached load and/or deformation.



**B044N SET**

### HARDWARE SPECIFICATIONS

- 8 independent channels available for the load cells or potentiometric transducers for load, or displacement measurements;
- Stabilized power supply of the analogical channels: 5 Vcc and 3 Vcc;
- Analogue input:  $\pm 20$  mV and  $\pm 5$  V;
- Nominal resolution: 24 bit;
- Acquisition up to 200 readings for each channel;
- Safety discrete On/off output;
- Graphic display 1/4 VGA colour Touch-Screen;
- Time and calendar system.

### FIRMWARE SPECIFICATIONS

- Instant visualization of the load measured by an extensometric cell.
- Instant visualization of the deformation measured by 4 linear displacement transducers.
- Visualization of the graphic of the test.

- Visualization of date and time.
- Semi-automatic configuration and calibration of all transducers connected.
- 20 steps lining that can be set by the enduser.
- Automatic correction of the axis origin for CBR/Marshall tests.
- Setting of all the parameters for test: alarms, zero threshold, end-test percentage, calculation parameters.
- Time/date and language selection (Italian, English, French, German, Spanish, Polish).
- Unlimited file for each type of test
- Symbols of pushbuttons functions
- Informative messages (planning alarms, load cell and strain transducer setting, etc.)
- Printing of the results on the incorporated thermal graphic printer (accessory C127N). Transfer and management via Ethernet of the filed data or real-time.

Hardware technical details: see p. 18

**B044N-SET is composed of:****B044N****CYBER-PLUS 8 EVOLUTION**

Unit for data acquisition.

Power supply: 230V 1F 50-60Hz.

**S337-34****LOAD CELL**

50kN capacity, with high precision strain transducers, complete with cable and connector.

**S336-14****LINEAR DISPLACEMENT TRANSDUCER**50 mm stroke, independent linearity  $\pm 0.1\%$  complete with cable and connector.

All necessary accessories for fixing the load cell and transducer to the test machine, are provided.

The system is calibrated ready to use and COMPLETE with a calibration certificate.

Every item can be ordered separately.

**ACCESSORIES****B043-01N**

SOFTWARE UTM2 (Universal Testing Machine 2)

Licence for **MARSHALL** test

Data processing program for "X-Y STABILITY/FLOW"

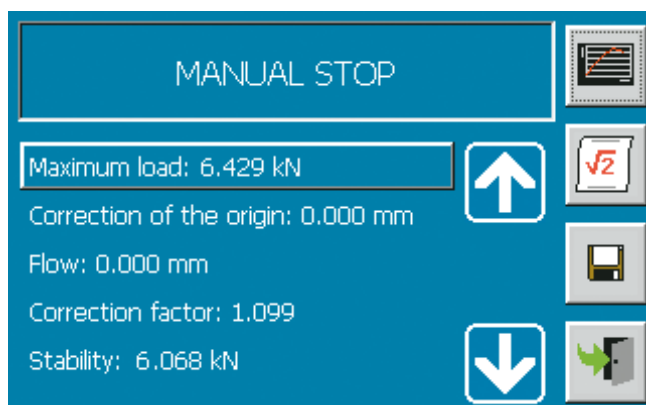
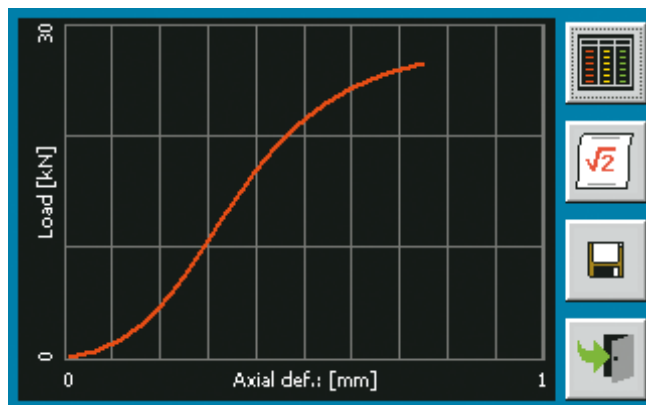
STANDARDS: EN 12697-34 | ASTM D6927, D5581, D1559  
BS 598:107 | NF P98-251-2**B043-02N**

SOFTWARE UTM2 (Universal Testing Machine 2)

Licence for **INDIRECT TENSILE STRENGTH**

STANDARDS: EN 12697-23 | ASTM D6931

**S218N**

SOFTWARE UTM2 (Universal Testing Machine 2)

Licence for **CBR** TestSTANDARDS: EN 13286-47 | UNI CNR 10009 | ASTM D1883  
BS 1377 | NF P94-078 | AASHTO T193**S218-01N**

SOFTWARE UTM2 (Universal Testing Machine 2)

Licence for **UNCONFINED** Test

STANDARDS: ASTM D2166

Description and technical details of Software UTM2: see p. 18

**H009-01**

PERSONAL COMPUTER, complete with LCD monitor 22", keyboard, mouse, connection cables, installation and setting up of the purchased software.

**C128**

LASER PRINTER for test certificate and graphics printing with direct connection to CYBER-PLUS 8.

S205M

**UNITRONIC 50 KN**

**UNIVERSAL MULTIPURPOSE TOUCH-SCREEN COMPRESSION, FLEXURAL AND TENSILE FRAME**

iTECH

**CYBER  
PLUS**  
 PROGRESS

- COMPRESSION AND FLEXURAL TESTS, 50 KN MAX. CAPACITY LOAD
- TENSILE TESTS, 25 KN MAX. CAPACITY LOAD (OPTION MOD. S205-05M)

With automatic load or displacement/deformation control, for testing:

**SOIL:**

- CBR (California Bearing Ratio)
- UNCONFINED COMPRESSION
- QUICK TRIAXIAL

**ASPHALT:**

- MARSHALL
- SPLITTING TENSILE
- DIRECT SHEAR (Leutner) on the connection between bituminous strata
- AUTO SCB

**CONCRETE:**

- FLEXURE ON BEAMS AND TILES

**CEMENT:**

- FLEXURE on 40x40x160 mm specimens
- COMPRESSION on cubes 40, 50, 70 mm
- TENSILE on mortar briquettes (option mod. S205-05M)

**METAL, PLASTIC, WIRES, ROPES, TEXTILES, PAPERS ETC.**

- TENSILE TESTS, 25kN max capacity load (option mod. S205-05M)

**CLAY BLOCKS:**

- PUNCHING

**ROCK AND STONES:**

- UNIAXIAL SPLITTING TENSILE

**S205M / S205-05M**

Equipped with suitable devices, Unitronic tester performs compression, flexural, splitting tensile and direct tensile tests, with automatic load or displacement/deformation control, within the limits of its max. **50 kN capacity** for compression/flexural **and 25 kN for tensile** (see model S205-05M). The load is applied by a mechanical jack that is driven by a stepper motor and controlled by an internal microprocessor on a **high precision control board**.

Stroke electric end switches are applied to the load piston to save the machine from accidental handlings.

The crosshead foresees couplings to fix the different test devices (see accessories). The stress is measured by an electric load cell and the displacement control is achieved directly by the high technology electronic board incorporated into the machine within a variable **speed range up to 51 mm/min** to cover the Marshall test.

Real time display of time, load, deformation, displacement and graph simultaneously is allowed thanks to the latest generation control board (See technical specifications – firmware).

## TECHNICAL SPECIFICATIONS

### HARDWARE

- Maximum Sample Diameter: 150 mm
- Minimum testing speed: 0.00001 mm/min
- Maximum testing speed: 51 mm/min
- Maximum compression force: 50 kN
- Minimum vertical clearance: 390 mm
- Maximum vertical clearance: 1110 mm
- Horizontal clearance: 380 mm
- Platen diameter: 177 mm
- Platen travel: 100 mm
- Unitronic 50 kN is **supplied without accessories and software** to perform specific tests that must be ordered separately (see accessories at next pages)

**Power supply:** 230V 1ph 50-60Hz 1500W

**Dimensions:** (h x w x d) 1675x500x530 mm approx.

**Weight:** 130 Kg approx.

### FIRMWARE

- Touch-screen TFT LCD graphic display, 800x480 pixels, 7 inches.
- Windows base interface (no external PC required either for advanced tests)
- 8 analog channels (24 bit) suitable for connection of load, displacement, deformation, LVDT, temperature (PT100, PT1000, NTC) transducers and strain gauges (by using an external adapter)
- 10 profiles, with a potential of 80 storable calibrations, for an immediate use of multiple sensors.
- Ports: Ethernet, RS232, RS485, 2 x USB Host-port
- Internal memory Slot for Micro SD

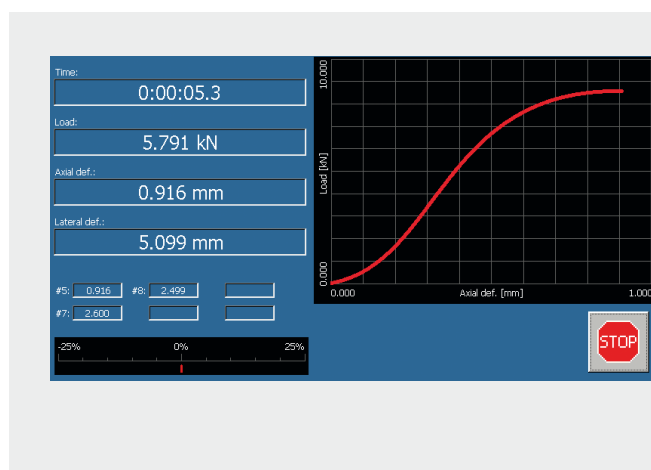

Indirect tensile bitumen test

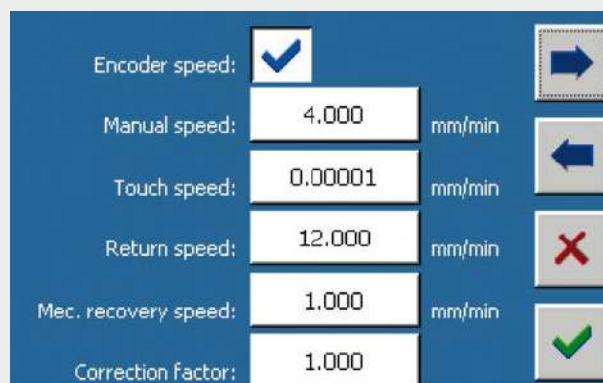

Device settings

### S205-05M

### UNITRONIC 25KN

### COMPRESSION AND TENSILE FRAME

The Unitronic frame S205M is modified and improved to perform also tensile tests with max. capacity of 25 kN

**Note:** This modification is possible only in MATEST factory.



Channels configuration



**S205N UNITRONIC 50 KN CAN PERFORM THE FOLLOWING TESTS:**

CBR TEST



MARSHALL TEST



CEMENT COMPRESSION



CONCRETE FLEXURE



QUICK TRIAXIAL



SPLITTING TENSILE



CEMENT FLEXURE



CLAY BLOCKS PUNCHING



UNCONFINED COMPRESSION

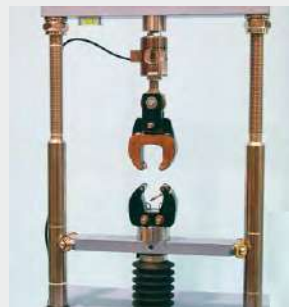

DIRECT SHEAR (LEUTNER)

 TENSILE TEST ON MORTAR  
 BRIQUETTES

TILE FLEXURE

 UNIAXIAL ROCK SPLITTING  
 TENSILE

AUTOMATIC SCB SYSTEM

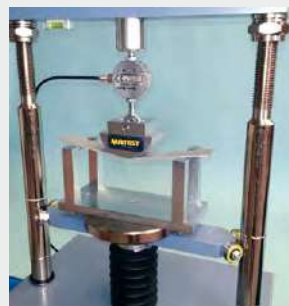
 TRANSVERSE / DEFORMATION  
 TEST ON ADHESIVE

 TENSILE TEST ON METALS,  
 PLASTIC, WIRES, TEXTILES ETC.

## S205N | S205-05N UNITRONIC, SPECIFIC APPLICATIONS

### CBR: CALIFORNIA BEARING RATIO TEST



STANDARDS:  
EN 13286 -47  
ASTM D1883  
BS 1377:4  
AASHTO T193  
NF P94-078  
CNR UNI 10009

Test development with displacement control.

- S205N** Unitronic 50 kN
- S337-34** Strain gauge load cell, 50 kN capacity
- S337-51** Calibration process of load cell / Unitronic
- S212-01** Penetration piston
- S218N** Software for CBR test

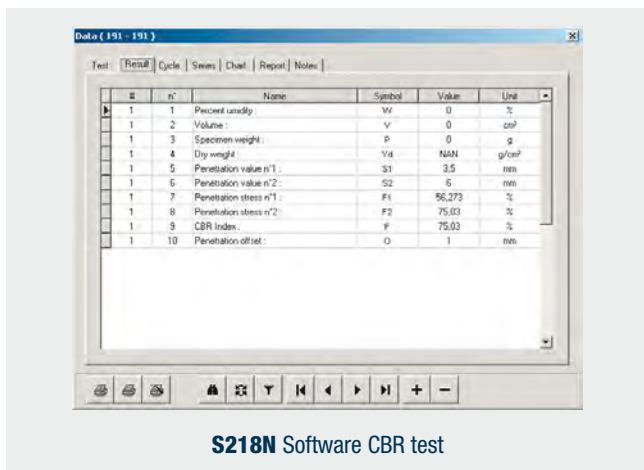

**S218N** Software CBR test

### QUICK TRIAXIAL TEST



STANDARDS:  
ASTM D2850  
BS 1377

Test development with displacement control.

**Note:**  
Additional needed accessories see p. 555, 556.

- S205N** Unitronic 50 kN
- S337-31** Strain gauge load cell 2.5 kN capacity
- S337-51** Calibration process of load cell / Unitronic
- S205-11** Loading piston with ball
- S305** Triaxial cell (for accessories see p. 546, 555, 556)
- S218-02N** Software for QUICK TRIAXIAL test

### UNCONFINED COMPRESSION TEST



STANDARDS:  
ASTM D2166  
BS 1377:7  
AASHTO T208

Test development with displacement control.

- S205N** Unitronic 50 kN
- S337-31** Strain gauge load cell 2.5 kN capacity.
- S337-51** Calibration process of load cell / Unitronic
- S212-08N** Upper and lower compression platens Ø 100 mm with accessories

As Alternative

- S212-09N** Upper + lower compression plates, Ø 165 mm with upper seat ball

- S218-01N** Software for Unconfined Compression test

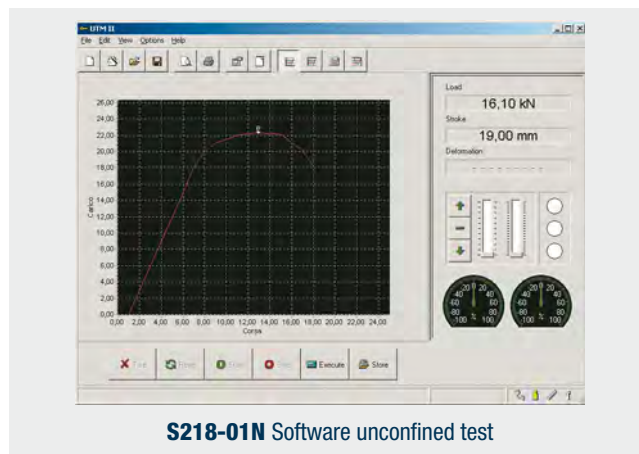

**S218-01N** Software unconfined test

### UNIAXIAL SPLITTING TENSILE TEST OF ROCK CORE SPECIMENS



STANDARD:  
ASTM D3667

Test development with displacement control.

- S205N** Unitronic 50 kN
- S337-34** Strain gauge load cell 50 kN capacity
- S337-51** Calibration process of load cell / Unitronic
- S212-05** Loading piston
- E171** Compression device

**MARSHALL STABILITY TEST**

STANDARDS:  
 EN 12697-34  
 ASTM D1559  
 D5581, D6927  
 AASHTO T245  
 BS 598 :107  
 NF P98-251-2

Test development with displacement control.

- S205N** Unitronic 50 kN
- S337-34** Strain gauge load cell, 50 kN capacity
- S337-51** Calibration process of load cell / Unitronic
- S212-05** Loading piston
- B046N** Stability mould
- B043-01N** Software for Marshall test

**SPLITTING TENSILE TEST**



STANDARDS:  
 EN 12697-23,12  
 ASTM D6931  
 AASHTO T283  
 CNR 134

Test development with displacement control.

- S205N** Unitronic 50 kN
- S337-34** Strain gauge load cell, 50 kN capacity
- S337-51** Calibration process of load cell / Unitronic
- S212-05** Loading piston
- B047-02** Splitting tensile device for samples Ø 4" and 6"
- B047-04** Set of TWO displacement transducers with accessories
- B043-02N** Software for Splitting Tensile test

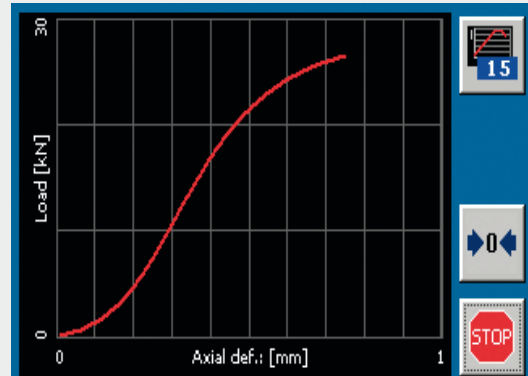

**S043-02N** Software splitting tensile test



**File Marshall test**



**B043-01N** Software Marshall test

**DIRECT SHEAR (LEUTNER) BETWEEN BITUMINOUS STRATA**

STANDARD:  
 ALP A StB T4

Test development with displacement control.

- S205N** Unitronic 50 kN
- S337-34** Strain gauge load cell 50 kN capacity
- S337-51** Calibration process of load cell / Unitronic
- S212-05** Loading piston
- B047-10** LEUTNER testing head for specimens Ø 150 mm
- B047-11** Spacers for Ø 100 mm specimens with Leutner head
- B043-03N** Software for Marshall and Leutner tests

Direct shear test (LEUTNER) on the connection between bituminous strata, carried out on asphalt cylinder specimens Ø 150 mm or 100 mm obtained from road cores or on laboratory made specimens.

## AUTO SCB SEMI-CIRCULAR BEND



STANDARDS:  
EN 12697-44  
AASHTO TP124  
ASTM D8044

Test development with displacement control.

### EN 12697-44

- B250-01** Basic indirect tensile (idt) jig, for 100-150 mm diameter
- B254-01** Scb jig (requires basic idt jig)
- B254-51** Pair of scb wear plates
- S337-34** Load cell 50 kn capacity

- B045-13** Loading piston
- S336-15** Transducer type "B" travel: 10 mm
- B045-14** Coupling hardware
- S335-15** Universal coupling pliers for transd./dial
- B043-05N** Software for auto-scb test

### AASHTO TP124 | ASTM D8044

- B208** SCB frame
- B254-02** Springs
- B254-10** Roller support
- S337-31(\*)** Load cell 2,5 kn capacity
- B045-13** Loading piston
- S336-15** Transducer type "b" travel: 10 mm
- B045-14** Coupling hardware
- S335-15** Universal coupling pliers for transd./dial
- B043-05N** Software for auto-scb test

 **Note:** for more details see p. 128.

## COMPRESSION TEST ON MORTAR SPECIMENS (50KN MAX. LOAD)



STANDARDS:  
EN 196-1  
EN ISO 679  
ASTM C109, C349  
NF P15-451  
BS 3892  
DIN 1164

Test development with displacement control.

- S205N** Unitronic 50 kN
- S337-34** Strain gauge load cell 50 kN capacity
- S337-51** Calibration process of load cell / Unitronic
- S212-05** Loading piston
- E170** Compression device on portion of 40x40x160 mm specimens
- E163N** Software for compression tests

## FLEXURAL TESTS ON MORTAR PRISM 40X40X160 MM



STANDARDS:  
EN 196-1  
ASTM C348  
NF P15-451  
DIN 1164  
EN ISO 679

Test development with displacement control.

- S205N** Unitronic 50 kN
- S337-32** Strain gauge load cell 10 kN capacity
- S337-51** Calibration process of load cell / Unitronic
- S212-05** Loading piston
- E172-01** Flexure EN device for 40x40x160 mm specimens (available also to ASTM, see p. 428)
- E164N** Software for flexural tests

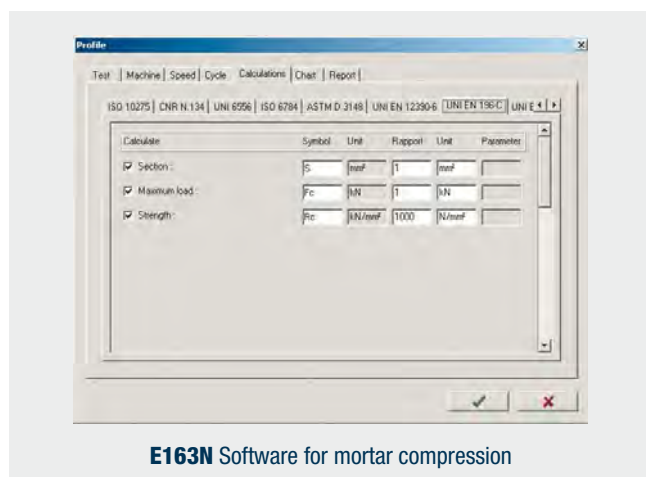

**E163N** Software for mortar compression

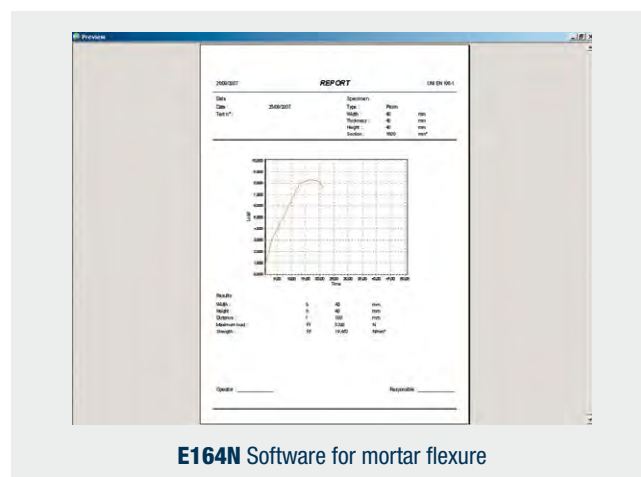

**E164N** Software for mortar flexure

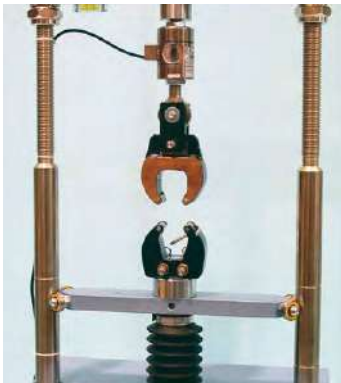
**TENSILE TEST ON MORTAR BRIQUETTES "8" SHAPED**

STANDARDS:  
 ASTM C190, C307  
 AASHTO T132

Test development with load control.

- S205-05N** Unitronic Compression 50 kN / Tensile 25 kN
- S337-32** Tensile/Compression strain load cell 10kN capacity
- S337-51** Calibration process of load cell / Unitronic
- S205-07** Tensile jaws "8" shaped for mortar briquette
- S205-08N** Software for tensile test
- E111** Briquette mould (see p. 408)

**TWO POINT FLEXURAL AND TRANSVERSE TESTS ON CONCRETE BEAMS AND BENDING TEST METHOD ON GLASS-FIBRE REINFORCED CONCRETE**

STANDARDS:  
 EN 12390-5  
 EN 1170-4  
 ASTM C78, C293

Test development with load control for concrete beams and displacement control for bending test on glass-fibre reinforce cement.

- S205N** Unitronic 50 kN
- S337-34** Strain gauge load cell 50 kN capacity
- S337-51** Calibration process of load cell / Unitronic
- S205-16** Two-point bending device to test glass-fibre reinforced cement. Rollers dimensions:  $\varnothing$  40 by 310 mm long. Lower rollers adjustable from 110 to 310 mm. Upper rollers adjustable from 45 to 120 mm. Weight: 20 kg approx
- C109-11N** Software for flexure tests on concrete beams

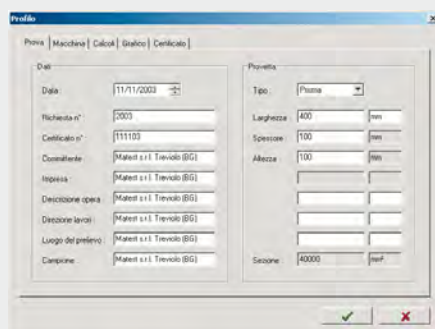

**C109-11N** Flexure: Outline of test data

**TRANSVERSE/DEFORMATION TEST ON ADHESIVES FOR TILES**

STANDARD:  
 EN 12004-2

Test development with displacement control.



**S205-13 A, B, C**

- S205N** Unitronic 50 kN
- S205-14** Strain gauge load cell 500 N capacity
- S337-51** Calibration process of load cell / Unitronic
- S205-13** Flexure device with lower bearers and upper loading piston
- S205-13A** Template A: rectangular frame for specimens to EN 12002, internal dimensions 280x45x5 mm
- S205-13B** Template B: mould for specimens to EN 12002, dimensions 300x45x3 mm
- S205-13C** Weight 100 N, cross sectional area of 290x45 mm, for preparation of specimens to EN 12002

**PUNCHING TEST ON CLAY BLOCKS**

STANDARDS:  
 EN 15037-2, -3  
 UNI 9730-3

Test development with load control.

- S205N** Unitronic 50 kN
- S337-32** Strain gauge load cell 10 kN capacity
- S337-51** Calibration process of load cell / Unitronic
- C093-11** Flexural punching device
- S205-15** Holding beam for the punching device
- C109-16N** Software for punching test on clay blocks

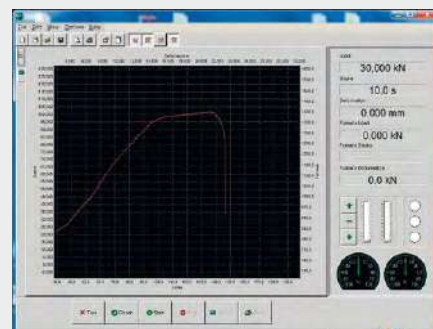

**C109-16N**

## FLEXURAL TEST FOR CENTRE POINT LOADING ON CLAY TILES AND CONCRETE BEAM



STANDARDS:  
EN 12390-5, 491, 538  
ASTM C78, C293  
BS 1881:118

Test development with  
load control.

- S205N** Unitronic 50 kN  
**S337-34** Strain gauge load cell, 50 kN capacity  
**S337-51** Calibration process of load cell / Unitronic  
**S205-18** Flexure device for centre point loading to test clay tiles and concrete beams dimensions 100x100x400(500) mm. Consisting of lower beam with two bearers (one articulated) adjustable from 110 to 310 mm, and upper central articulated bearer fixed to the load cell. Bearer dimensions: Ø 40 mm by 310mm long.  
 Weight: 20 kg approx  
**C109-11N** Software for flexure tests

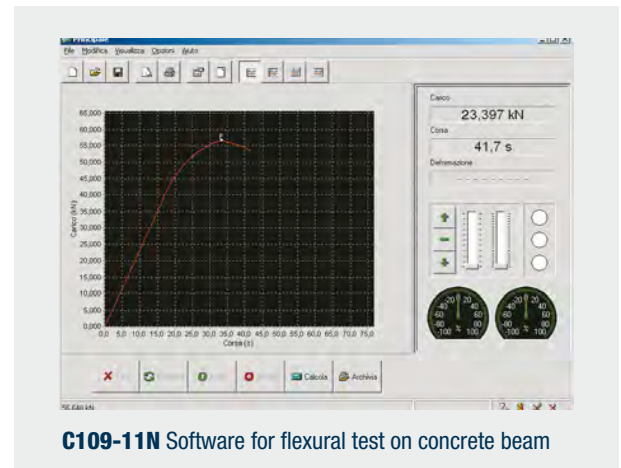

**C109-11N** Software for flexure test on concrete beam

## TENSILE TESTS ON METALS, PLASTICS, WIRES, TEXTILES ETC.



STANDARDS:  
ASTM D2166  
BS 1377:7  
AASHTO T208

Test development with  
load control.

- S205-05N** Unitronic Compression 50 kN / Tensile 25 kN  
**S337-36** Tensile strain load cell 25 kN capacity  
**S337-51** Calibration process of load cell / Unitronic  
**H005-11** Tensile heads (upper and lower)  
**S205-09** Coupling for tensile heads installation  
**H005-21** Flat seizing grips for flat specimens 1 - 10 mm thickness by 25 mm max. width and round specimens Ø 3-5 mm  
**H005-31** "V" shape seizing grips for round specimens Ø 5-12 mm  
**H014-06 to H014-10** Extensometer, electronic, for tensile deformation strength tests. (See p. 445)  
**H009N** Software for visualisation in real time of load/deformation, graphic, test certificate etc

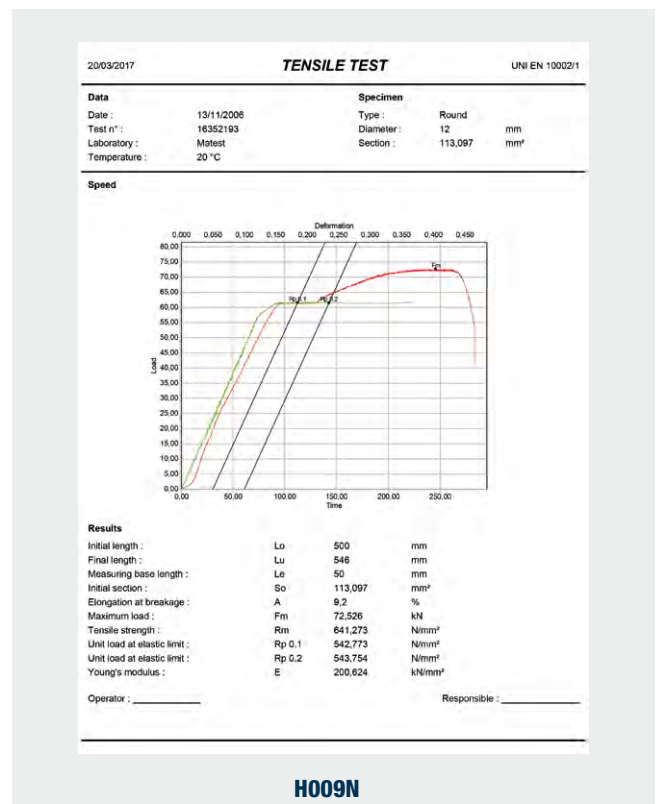

**H009N**

At p. 444 you will find devices to test plastics, wires, ropes, flexural and bending tests and various models of extensometers. On request it is also possible to equip the Unitronic frame S205-05N with devices for tensile tests of different materials, within the 25kN max. capacity load.

**Note:** Needed accessories listed above, are common for different tests. We recommend to check them when ordering, to avoid duplications.

**S206N**  
**UNITRONIC 200 KN**  
**UNIVERSAL MULTIPURPOSE TOUCHSCREEN**  
**COMPRESSION/FLEXURAL AND TENSILE FRAME FOR:**

- COMPRESSION / FLEXURAL TESTS, 200 kN MAX. CAPACITY LOAD
- TENSILE TESTS, 50 kN MAX. CAPACITY LOAD

With automatic load or displacement/deformation control, for testing:

**SOIL:**

- CBR (California Bearing Ratio)

**ASPHALT:**

- DURIEZ
- MARSHALL
- SPLITTING TENSILE
- DIRECT SHEAR (Leutner) on the connection between bituminous strata

**CONCRETE:**

- FLEXURE ON BEAMS AND TILES

**CEMENT:**

- FLEXURE on 40x40x160 mm specimens
- COMPRESSION on cubes 40, 50, 70 mm

**METAL, PLASTIC, WIRES, ROPES, TEXTILES, PAPERS ETC.**

- TENSILE TESTS, 50kN max capacity load

**CLAY BLOCKS:**

- PUNCHING

**ROCK AND STONES:**

- UNIAXIAL SPLITTING TENSILE



**S206N**

**TECHNICAL FEATURES:**

By using suitable devices, Unitronic tester, within the limits of its max. 200 kN capacity for compression/flexural and 50 kN for tensile, performs compression, flexural, splitting tensile and direct tensile tests, with automatic load or displacement/deformation control.

The load is applied by a mechanical jack that is driven by a motor **brushless with closed loop through optic encoder** and controlled by a microprocessor. Stroke electric end switches are applied to the load piston to save the machine from accidental handlings.

The two crossheads foresee couplings to fix the different test devices (see accessories). The stress is measured by an electric load cell; the measurement and the displacement control of the crosshead is achieved by the electronic device incorporated into the machine.

## FIRMWARE

- Electronic control unit “Cyber-plus Evolution” with Touch-Screen colour display, that runs like a standard PC based on Windows operating system for the management and analysis of the data, test results, graphs.
- The Touch-Screen icon interface allows an easy set up of the parameters and immediate execution of the test.
- The machine can be connected to a PC for remote test execution through suitable Software; the machine can in any case perform the tests without any external PC, because of the “Cyber-Plus” grants performances like a PC.
- Direct connection to Intranet (connection to a LAN network) and Internet to establish a remote communication and receive an immediate diagnostic analysis from Matest technicians, or for updates of the software.
- Unlimited memory storage with: 2 USB ports, 1 SD card slot.
- RJ45 network connection
- Possibility to select different languages.
- Hardware technical details: see p. 18

## SPECIFICATIONS OF THE FRAME

- Max. load: 200 kN Compression; 50 kN tensile.
- Max. vertical daylight: 900 mm (without accessories)
- Max. vertical daylight with compression platens: 800 mm
- Compression platens diameter: 216 mm (upper platen on seat ball)
- Distance between columns: 650 mm
- Crosshead travel:  $\pm 200$  mm (400 mm total)
- Testing speed range: from 0.01 to 100 mm/min
- Load rate: from 1 N/s to 5 kN/s
- Displacement resolution: 0.01 mm with accuracy better than 0.2%
- Machine Class: 1

The Unitronic 200 kN is **supplied complete with**:  
Electric load cell 200 kN capacity, crosshead displacement device, upper with seat ball and lower compression platens.

**Are not included**: accessories and software for specific tests that must be ordered separately (see accessories).

**Note**: The machine can be equipped with intermediate load cells to the max. capacity of the machine, to satisfy specific test requirements.

**Power supply**: 230V 1ph 50-60Hz 850W

**Dimensions**: 950x560x2400 mm

**Weight**: 820 kg approx.

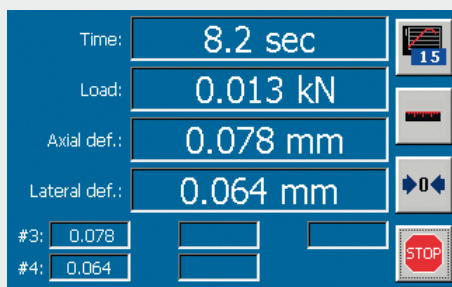

UNITRONIC screen examples: CBR test

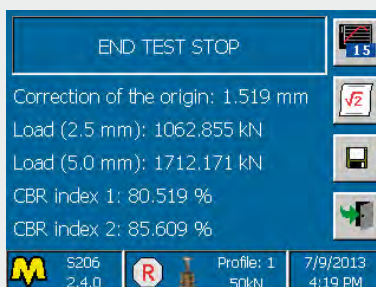

CBR test result

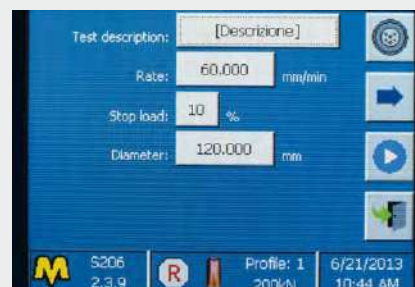

S206-21N Software for Duriez test

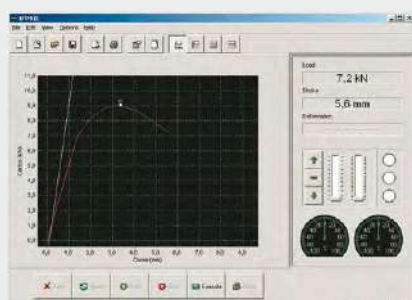

B043-01N Software Marshall test

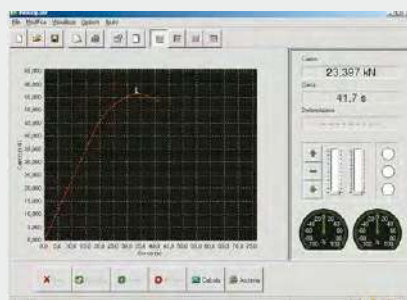

C109-11N Software for flexural test on concrete beam

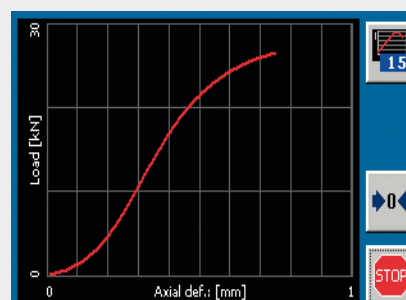

File Marshall test



**S206N UNITRONIC 200 KN CAN PERFORM THE FOLLOWING TESTS:**

CBR TEST



MARSHALL TEST



CEMENT COMPRESSION



CONCRETE FLEXURE

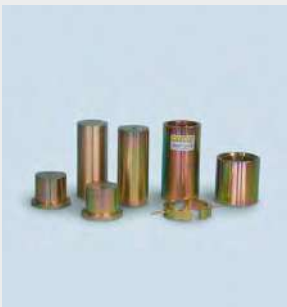

DURIEZ



SPLITTING TENSILE BITUMEN



CEMENT FLEXURE



CLAY BLOCKS PUNCHING



UNCONFINED COMPRESSION



DIRECT SHEAR (LEUTNER)

 SPLITTING TENSILE  
 BLOCK PAVERS

TILE FLEXURE

 UNIAXIAL ROCK SPLITTING  
 TENSILE

AUTOMATIC SCB SYSTEM

 SPLITTING TENSILE  
 CONCRETE CYLINDERS

 TENSILE TEST ON METALS,  
 PLASTIC, WIRES, TEXTILES ETC.

**Note:** S206N UNITRONIC 200 kN can perform many other different test (like for ex.: quick triaxial, unconfined, etc.) by utilizing suitable accessories and electric load cells.

## S206N UNITRONIC 200 KN, CAN PERFORM THE FOLLOWING TESTS:

### CBR: CALIFORNIA BEARING RATIO TEST

STANDARDS: EN 13286 -47 | ASTM D1883 | BS 1377:4  
AASHTO T193 | NF P94-078 | CNR UNI 10009



CBR Mould

- S206N** Unitronic 200 kN
- S337-34** Strain gauge load cell 50 kN capacity
- S337-51** Calibration process of load cell / Unitronic
- S206-31** Flange/connector of the load cell S337-34
- S212-01** Loading piston
- S218N** Software for CBR test (p. 18)

### DURIEZ TEST ON 80 AND 120 MM DIAMETER SAMPLES

STANDARD: NF P98-251/1, NF P98-251/4



B095-01

- S206N** Unitronic 200 kN
- B096-01** Duriez set Ø 80 mm (p. 131)
- B095-01** Duriez set Ø 120 mm (p. 131)
- S206-21N** Software for Duriez test (p. 18)

### MARSHALL STABILITY TEST

STANDARDS: EN 12697-34 | ASTM D1559, D5581, D6927  
AASHTO T245 | BS 598:107 | NF P98-251-2



B046N

- S206N** Unitronic 200 kN
- S337-34** Strain gauge load cell 50 kN capacity
- S337-51** Calibration process of load cell / Unitronic
- S206-31** Flange/connector of the load cell S337-34
- S212-05** Loading piston
- B046N** Stability mould
- B043-01N** Software for Marshall test (p. 18)

### DIRECT SHEAR (LEUTNER) BETWEEN BITUMINOUS STRATA

STANDARD: ALP A StB t.4

Direct shear test (LEUTNER) on the connection between bituminous strata, carried out on asphalt cylinder specimens Ø 150 mm or 100 mm obtained from road cores or on laboratory made specimens.



S337-34

S212-05

- S206N** Unitronic 200 kN
- S337-34** Strain gauge load cell 50 kN capacity
- S337-51** Calibration process of load cell / Unitronic
- S206-31** Flange/connector of the load cell S337-34
- S212-05** Loading piston
- B047-10** LEUTNER testing head for specimens Ø 150 mm
- B047-11** Spacers for Ø 100 mm specimens with Leutner head
- B043-03N** Software for Leutner and Marshall tests (p. 18).

B047-10 + B047-11

### SPLITTING TENSILE TEST

STANDARDS: EN 12697-23, 12 | ASTM D6931 | AASHTO T283  
CNR 134



B047-02 + B047-04

- S206N** Unitronic 200 kv
- S337-34** Strain gauge load cell 50 kN capacity
- S337-51** Calibration process of load cell / Unitronic
- S206-31** Flange/connector of the load cell S337-34
- S212-05** Loading piston
- B047-02** Splitting tensile device for samples Ø 4" and 6" (p. 123)
- B047-04** Set of TWO displacement transducers with accessories (p. 123)
- B043-02N** Software for Splitting Tensile test (p. 18)

### PULL OFF TENSION TEST

STANDARD: TP ASPHALT - StB 81

- S206N** Unitronic 200 kN
- B260-10SP** Pull off tension jig
- H009N** Software for tensile test
- S337-51** Calibration process of load cell / Unitronic

 **Note:** Accessories for temperature measurement not included.



B260-10SP

## FLEXURAL TEST ON CONCRETE BEAMS

STANDARDS: EN 12390-5 | ASTM C78, C293 | AASHTO T97  
 NF P18-407 | BS 1881:118 | UNE 83305



- S206N** Unitronic 200 kN  
**C106** Flexure device (p. 315)  
**C109-11N** Software for flexural tests on concrete beams. (p. 18)

## TWO POINT FLEXURAL AND TRANSVERSE TESTS ON CONCRETE BEAMS AND BENDING TEST METHOD ON GLASS-FIBRE REINFORCED CONCRETE

STANDARDS: EN 1170-4, EN 12390-5 | ASTM C78, C293

- S206N** Unitronic 200 kN  
**S337-34** Strain gauge load cell 50kN capacity  
**S337-51** Calibration process of load cell / Unitronic  
**S205-16** Four-point bending device to test glass-fibre reinforced concrete.  
 Rollers dimensions: Ø 40 by 310 mm long  
 Lower rollers adjustable from 110 to 310 mm  
 Upper rollers adjustable from 45 to 120 mm  
 Weight: 20 kg approx.  
**S206-31** Flange/Connector of the load cell S337-34  
**C109-11N** Software for flexure tests on concrete beams (p. 18)



**S205-16**

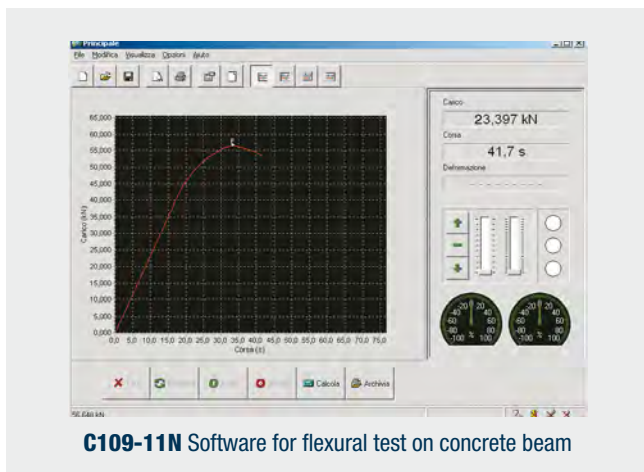

**C109-11N** Software for flexural test on concrete beam

## FLEXURAL TEST WITH CENTRE POINT ON CONCRETE BEAMS AND CLAY TILES

STANDARDS: EN 12390-5 | ASTM C78, C293 | BS 1881:118

- S206N** Unitronic 200 kN  
**S205-18** Flexure device with centre point loading to test clay tiles and concrete beams dimensions 100x100x400(500) mm  
 Consisting of lower beam with two bearers (one articulated) adjustable from 100 to 315 mm, and upper central articulated bearer fixed to the load cell.  
 Weight: 20kg approx.  
**S337-34** Strain gauge load cell 50 kN capacity (to replace the 200 kN load cell)  
**S206-31** Flange/connector of the load cell S337-34  
**C109-11N** Software for flexural tests on concrete beams (p. 18)



**S205-18**

## SPLITTING TENSILE TEST ON CONCRETE CYLINDERS

STANDARDS: EN 12390-6 | ASTM C496 | NF P18-408 | BS 1881:117



- S206N** Unitronic 200 kN  
**C100-01** Splitting tensile test device (technical details and other devices: p. 314)  
**C100-01** Packing strips for the device C100-01  
**C109-12N** Software for splitting tensile test. (p. 18)

## SPLITTING TENSILE TEST ON CONCRETE CUBES AND BLOCK PAVERS

STANDARDS: EN 1338 | EN 12390-6



- S206N** Unitronic 200 kN  
**C103** Splitting tensile test device (p. 314)  
**C100-02** Packing strips for the device C103  
**C109-12N** Software for Splitting tensile test (p. 18)

## PUNCHING TEST ON CLAY BLOCKS

STANDARDS: EN 15037-2, 15037-3 | UNI 9730-3



- S206N** Unitronic 200 kN
- C093-11** Punching device for clay block for flooring tests
- S205-15** Holding beam for the device
- S337-32** Strain gauge load cell 10 kN capacity
- S206-32** Flange/Connector for the load cell S337-32
- S337-51** Calibration process of load cell / Unitronic
- C109-16N** Software for the punching test (p. 18)

## COMPRESSION TEST ON MORTAR SPECIMENS

STANDARDS: EN 196-1 | ASTM C109, C349 | NF P15-451  
EN ISO 679 | DIN 1164



- S206N** Unitronic 200 kN
- E170** Compression device on portions of 40x40x160 mm specimens  
(devices for different specimens described at p. 428)
- E163N** Software for the compression test (p. 18)

## FLEXURAL TEST ON MORTAR PRISMS 40X40X160 MM

STANDARDS: EN 196-1 | ASTM C348 | NF P15-451  
DIN 1164 | EN ISO 679



- S206N** Unitronic 200 kN
- E172-01** Flexure device for 40x40x160 mm specimens  
(available also device to ASTM, see p. 428)
- S337-32** Strain gauge load cell 10 kN capacity
- S206-32** Flange/connector of the load cell S337-32
- S337-51** Calibration process of load cell / Unitronic
- E164N** Software for the flexural test (p. 18)

## TENSILE TESTS ON METALS, PLASTICS, WIRES, TEXTILES ETC.

STANDARDS: ASTM D2166 | BS 1377:7 | AASHTO T208

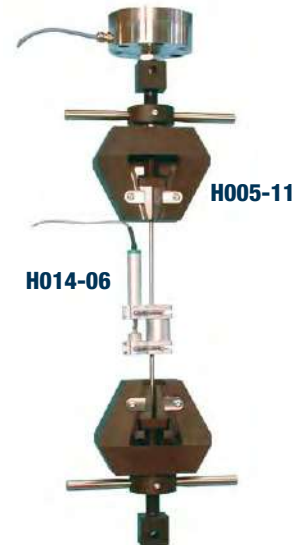

- S206N** Unitronic 200 kN
- H005-11** Tensile heads, upper and lower (p. 444).  
Daylight between heads: min. 50 mm / max. 420 mm
- S206-33** Flange/connector of the tensile heads H005-11
- H005-21** Flat seizing grip for flat specimens 1-10 mm thickness  
by 25 mm max. width, and round specimens  $\varnothing$  3-5 mm
- H005-31** "V" shape seizing grips for round specimens  $\varnothing$  5-12 mm

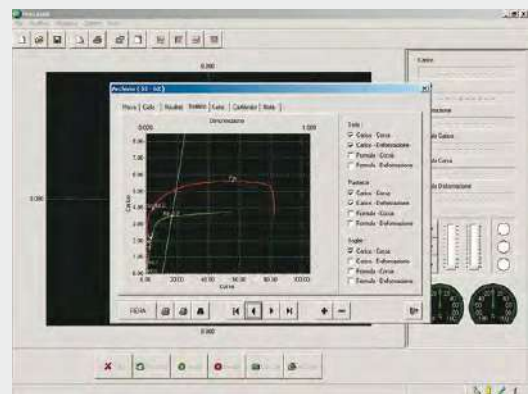

**H009N** Practical example of a saving test graph where the user can select which traces have to be shown, modify the scales or personalize the colors and give a new name to the axis upgrading.

## OPTIONAL ACCESSORIES

- H014** Extensometer, electronic, for tensile deformation strength tests (p. 445)
- H009N** Software for load/deformation, graphs, test certificate  
Technical specifications: see p. 449 where there are also listed devices to test plastics, wires, ropes, flexural and bending tests and various models of extensometers.

**Note:** Accessories for specific tests listed above, are common for different tests. We recommend to check them when ordering, to avoid duplications.

## PLATE BEARING TEST

STANDARDS: ASTM D1194, D1195, D1196 | BS 1377:9 | CNR N° 92 and 146 | UNE 7391 | Comparable to DIN 18134

This test is performed for the determination of the bearing capacity of a soil in-situ on road constructions, foundations, road subgrades, airport and highway pavements.

A wide range of plate bearing test equipment is available, together with many accessories according to the different Standards and specific end-user needs.

The hand pumps 100 kN and 200 kN capacity are “Enerpac Made” and all models have double speed, ensuring fast approach.

### AVAILABLE MODELS

#### S222 KIT PLATE BEARING TEST EQUIPMENT

**100 KN CAPACITY - 1 DIAL GAUGE MODEL**  
 ANALOGUE MEASURING SYSTEM WITH DIAL MANOMETER  
 STANDARD: CNR N° 146, method “A”

Consisting of:

- S222-01** Hydraulic jack 100 kN capacity, complete with hand pump, rubber pipe with fast connector, set of extension rods of different lengths, carrying case.
- S222-02** Analogue pressure gauge 0-100 kN, div. 0.5 kN
- S226-05** Load plate Ø 300 mm
- S226-12** Device for centre dial gauge measure, with spherical seat.
- S222-03** Datum bar assembly, 2.5 m long, telescopic, aluminium made, adjustable in height, complete with base supports, plumb and spirit level. Packed separately.
- S377** Dial gauge 25x0.01 mm
- S226-16** Articulated dial gauge support with adjustment device.

**Weight:** 60 kg approx.



**S223-01 | S223-02**

#### S222D KIT PLATE BEARING TEST EQUIPMENT

**100KN CAPACITY - 1 DIGITAL GAUGE MODEL**  
 DIGITAL MEASURING SYSTEM WITH DIGITAL MANOMETER



Same composition of S222KIT except:

- S222-02D** Digital pressure manometer 0 - 100 kN with 10N resolution, instead of the analogue gauge S222-02.

#### S222-02D | S225-02D DIGITAL PRESSURE MANOMETER

The applied load is measured by a high precision electric load cell with digital display, **granting accurate readings also at low loads.**

- 65.000 divisions
- 10N resolution
- linearity: 0.05%
- hysteresis: 0.03%
- repeatability: 0.02%
- display: LCD with high visibility
- display height: 16 mm
- battery operated, 12 months life



**S222-02D | S225-02D**



**S222 KIT**

**S222-02D  
S225-02D**

#### ACCESSORY for S222 KIT and S223 KIT

- S223-01** PRESSURE GAUGE, range 0 - 50 kN, div. 0.25 kN with large dial Ø 200 mm, complete with fast connector, used **for accurate readings at low loads**, as for ex. pre-load of 0.5 kg/cm<sup>2</sup>.

**S223 KIT****PLATE BEARING TEST EQUIPMENT 100 kN CAPACITY - 3 DIAL GAUGES MODEL**

ANALOGUE MEASURING SYSTEM WITH DIAL MANOMETER

STANDARDS: CNR N° 146, method "B" | BS 1377:9

Consisting of:

**S222-01** Hydraulic jack 100 kN capacity, complete with hand pump, rubber pipe with fast connector, set of extension rods of different lengths, carrying case.**S222-02** Analogue pressure gauge 0-100 kN, div. 0.5 kN.**S226-13** Upper spherical seat.**S226-05** Load plate Ø 300 mm**S226-06** Intermediate plate Ø 160 mm**S222-03** Datum bar assembly, 2.5 m long, telescopic, aluminium made, adjustable in height, complete with base supports, plumb and spirit level. Packed separately.

(Alternative solutions: S223-03 "Y" measuring system, Swiss method. See p. 519).

**S377** n° 3 dial gauges 25x0.01 mm**S226-16** n° 3 articulated dial gauge supports with adjustment device.**Weight:** 60 kg approx.**S223 KIT****S223D KIT****PLATE BEARING TEST EQUIPMENT 100 kN CAPACITY - 3 DIAL GAUGES MODEL**

DIGITAL MEASURING SYSTEM WITH DIGITAL MANOMETER

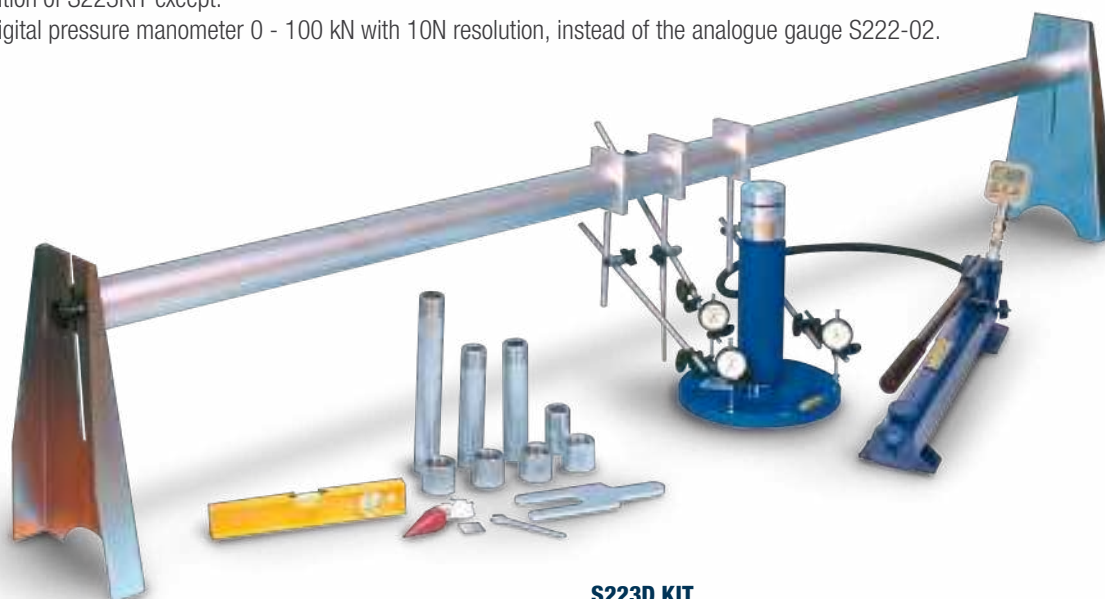

Same composition of S223KIT except:

**S222-02D** Digital pressure manometer 0 - 100 kN with 10N resolution, instead of the analogue gauge S222-02.**S223D KIT**

**S225 KIT**
**PLATE BEARING TEST EQUIPMENT 200 KN CAPACITY - 3 DIAL GAUGES MODEL**

ANALOGUE MEASURING SYSTEM WITH DIAL MANOMETER

STANDARDS: CNR N° 146, method "B" | BS 1377:9, and using loading plates (accessory) dia. 450, 600, 760 mm, it meets also: ASTM D1195, D1196 | CNR N. 92

Consisting of:

- S225-01** Hydraulic jack 200 kN capacity, complete with hand pump, rubber pipe with fast connector, set of extension rods of different lengths, carrying case.
- S225-02** Analogue pressure gauge 0-200 kN, div. 1 kN.
- S226-13** Upper spherical seat.
- S226-05** Load plate Ø 300 mm
- S226-06** Intermediate plate Ø 160 mm
- S222-03** Datum bar assembly, 2.5 m long, telescopic, aluminium made, adjustable in height, complete with base supports, plumb and spirit level. Packed separately. (Alternative solutions: S223-03 "Y" measuring system, Swiss method. See p. 519).
- S377** n° 3 dial gauges 25x0.01 mm
- S226-16** n° 3 articulated dial gauge supports with adjustment device.

**Weight:** 70 kg approx.

**S225D KIT**
**PLATE BEARING TEST EQUIPMENT**
**200 KN CAPACITY - 3 DIAL GAUGES MODEL**

DIGITAL MEASURING SYSTEM WITH DIGITAL MANOMETER

Same composition of S225KIT except:

- S225-02D** Digital pressure manometer 0 - 200 kN with 10N resolution, instead of the analogue gauge S225-02.

**B103-10**
**BEARING PLATE 600 MM Ø CAST ALUMINIUM**

STANDARD: NF P94-117-1

Used to determine the static deformation of flexible road pavement and with the plate bearing equipment.

Technical details: see p. 167

**ACCESSORY for S225 KIT**

- S223-02** PRESSURE GAUGE, range 0 - 50 kN, div. 0.25 kN with large dial Ø 200 mm, complete with fast connector, used for accurate readings at low loads, as for ex. pre-load of 0.5 kg/cmq.

**B103-10**

**S226 KIT****PLATE BEARING TEST EQUIPMENT 500 KN CAPACITY - 3 DIAL GAUGES MODEL**

ANALOGUE MEASURING SYSTEM WITH DIAL MANOMETER

STANDARDS: CNR N° 146, method "B" | BS 1377:9, and using loading plates (accessory) Ø 450, 600, 760 mm, it meets also:  
ASTM D1195, D1196 | CNR N. 92

Consisting of:

**S227-02** Hydraulic jack 500 kN capacity, complete with hand pump, spherical seat, rubber pipe with fast connector, set of extension rods of different lengths, carrying case.**S227-03** Analogue pressure gauge 0-500 kN, div. 2 kN.**S226-05** Load plate Ø 300 mm**S226-06** Intermediate plate Ø 160 mm**S222-03** Datum bar assembly, 2.5 m long, telescopic, aluminium made, adjustable in height, complete with base supports, plumb and spirit level. Packed separately. (Alternative solutions: S223-03 "Y" measuring system, Swiss method. See p. 519).**S377** n° 3 dial gauges 25x0.01 mm**S226-16** n° 3 articulated dial gauge supports with adjustment device.**Weight:** 110 kg approx.**S226 KIT****S226D KIT****PLATE BEARING TEST EQUIPMENT 500 KN CAPACITY - 3 DIAL GAUGES MODEL**

DIGITAL MEASURING SYSTEM WITH DIGITAL MANOMETER

STANDARDS: CNR N° 146, method "B" | BS 1377:9, and using loading plates (accessory) Ø 450, 600, 760 mm, it meets also:  
ASTM D1195, D1196 | CNR N. 92

Same composition of S226 KIT except for:

**S227-03D** Digital pressure manometer 0 - 500 kN with 20N resolution, instead of the analogue gauge S227-03.**S226D KIT**



**S224 KIT**
**DIGITAL PLATE BEARING TEST EQUIPMENT 100 KN CAPACITY**

## 3 LINEAR DISPLACEMENT TRANSDUCERS AND CYBER-PLUS DATA ACQUISITION SYSTEM

STANDARDS: CNR N° 146, method "B" | BS 1377:9

Consisting of:

- S222-01** Hydraulic jack 100 kN capacity, complete with hand pump, rubber pipe with fast connector, set of extension rods of different lengths, carrying case.
- S226-13** Upper spherical seat.
- C116-09S** Pressure transducer, connected to the pump.
- C405-15N** Cyber-Plus Evolution "Touch Screen" for data acquisition, visualization, processing and storing, directly connected to PC or printer. Technical details: see p. 520
- S224-21N** Software for test data processing.
- S226-05** Load plate Ø 300 mm
- S226-06** Intermediate plate Ø 160 mm
- S222-03** Datum bar assembly, 2.5 m long, telescopic, aluminium made, adjustable in height, complete with base supports, plumb and spirit level. Packed separately. (Alternative solutions: S223-03 "Y" measuring system, Swiss method. See p. 519).
- S336-14** n° 3 linear displacement transducers, 50 mm travel.
- S336-31** n° 3 Extension cables for transducer, 5 m long.
- S226-16** n° 3 articulated transducer supports with adjustment device.
- S335-15** n° 3 universal coupling pliers for transducers.

**Weight:** 60 kg approx.

**S224-01 KIT**
**DIGITAL PLATE BEARING TEST EQUIPMENT 200 KN CAPACITY**

## 3 LINEAR DISPLACEMENT TRANSDUCERS AND CYBER-PLUS DATA ACQUISITION SYSTEM

 STANDARDS: CNR N° 146, method "B" | BS 1377:9, and using loading plates (accessory) Ø 450, 600, 760 mm, it meets also:  
 ASTM D1195, D1196 | CNR N. 92

Consisting of:

- S225-01** Hydraulic jack 200 kN capacity, complete with hand pump, rubber pipe with fast connector, set of extension rods of different lengths, carrying case.
- S226-13** Upper spherical seat.
- C116-09S** Pressure transducer, connected to the pump.
- C405-15N** Cyber-Plus Evolution "Touch Screen" for data acquisition, visualization, processing and storing, directly connected to PC or printer. Technical details: see p. 520
- S224-21N** Software for test data processing.
- S226-05** Load plate Ø 300 mm
- S226-06** Intermediate plate Ø 160 mm
- S222-03** Datum bar assembly, 2.5 m long, telescopic, aluminium made, adjustable in height, complete with base supports, plumb and spirit level. Packed separately. (Alternative solutions: S223-03 "Y" measuring system, Swiss method. See p. 519).
- S336-14** n° 3 linear displacement transducers, 50 mm travel.
- S336-31** n° 3 Extension cables for transducer, 5 m long.
- S226-16** n° 3 articulated transducer supports with adjustment device.
- S335-15** n° 3 universal coupling pliers for transducers.

**Weight:** 70 kg approx.

**S224-01 KIT**  
 (similar to S224 KIT and S224-02 KIT)

**S224-02 KIT****DIGITAL PLATE BEARING TEST EQUIPMENT 500 KN CAPACITY****3 LINEAR DISPLACEMENT TRANSDUCERS AND CYBER-PLUS DATA ACQUISITION SYSTEM**

STANDARDS: CNR N° 146, method "B" | BS 1377:9, and using loading plates (accessory) Ø 450, 600, 760 mm, it meets also:  
ASTM D1195, D1196 | CNR N. 92

Consisting of:

- S227-02** Hydraulic jack 500 kN capacity, complete with hand pump, spherical seat, rubber pipe with fast connector, set of extension rods of different lengths, carrying case.
- C116-09S** Pressure transducer, connected to the pump.
- C405-15N** Cyber-Plus 8 Evolution "Touch Screen" for data acquisition, visualization, processing and storing, directly connected to PC or printer.  
Technical details: see p. 520
- S224-21N** Software for test data processing
- S226-05** Load plate Ø 300 mm
- S226-06** Intermediate plate Ø 160 mm
- S222-03** Datum bar assembly, 2.5 m long, telescopic, aluminium made, adjustable in height, complete with base supports, plumb and spirit level. Packed separately. (Alternative solution: S223-03 "Y" measuring system, Swiss method).
- S336-14** n° 3 linear displacement transducers, 50 mm travel.
- S336-31** n° 3 Extension cables for transducer, 5 m long.
- S226-16** n° 3 articulated transducer supports with adjustment device.
- S335-15** n° 3 universal coupling pliers for transducers.

**Weight:** 110 kg approx.

**ACCESSORIES**

- S226-01** LOADING PLATE Ø 450 mm
- S226-02** LOADING PLATE Ø 600 mm
- S226-03** LOADING PLATE Ø 760 mm
- S226-09** SET OF TELESCOPIC EXTENSION RODS, aluminium made, to be connected to the datum bar mod. S222-03 (2.5 m long) to obtain a max. adjustable length of 5.5 m as requested by ASTM, CNR Specifications

**S223-03****"Y" MEASURING SYSTEM - SWISS METHOD**

STANDARD: SNV 70312

Aluminium alloy made, lightweight and very easy to use, it may be used as alternative solution to the datum bar assembly mod. S222-03. This system is applicable to the plate bearing equipment with 3 dial gauge or 3 displacement transducers.

**Weight:** kg 7 approx.



**S223-03 + S226-16**

**S226-50****OFFICIAL ACCREDIA CALIBRATION CERTIFICATE**

(equivalent UKAS, ENAC, DAKKS, SAS, COFRAC etc.) of the applied load for the Bearing Test Equipment from mod. S222KIT to mod. S226KIT (p. 514 to 518) and for Field CBR/Unconfined test equipment mod. S131KIT, S210KIT, S220KIT (see p. 492...508).

The calibration is carried out only at Matest factory.



**S226-01 + S226-02 + S226-03**



**S226-09 + S222-03**

**BENKELMAN BEAM APPARATUS**

STANDARDS: NF P94-117-1 | NF P98-200/2 | AASHTO:T256

Utilized in conjunction with the plate bearing test equipment, to determine the static deformation of road pavements EV1 - EV2 and Westergard. See section "B" Bitumen, mod. B100 p. 166



## C405-15M CYBER-PLUS TOUCH SCREEN

### DATA ACQUISITION AND PROCESSING SYSTEM

8 Channels acquisition and processing data system, 24 bit resolution. Electronic advanced technology, **display** LCD, TFT, 800x480 pixels, 7", **touch screen**, high graphic performances, the unit automatically performs test and data processing. A certificate can be printed through an external USB printer (optional). The Cyber-Plus is equipped with LAN port for connection to PC and with USB port for an unlimited memory storage.

Contained in a practical and sturdy watertight carrying case, can be powered from an electrical network 90-270 V or use the internal battery and charger granting one full day on-site use.

Hardware technical details: see p. 18

### HARDWARE SPECIFICATIONS

- 8 independent channels available for the load cells or potentiometric transducers for load, or displacement measurements;
- Stabilized power supply of the analogical channels: 5 Vcc and 3 Vcc;
- Analogue input:  $\pm 20$  mV and  $\pm 3$  V;
- Nominal resolution: 24 bit;
- Acquisition up to 200 Hz readings for each channel;
- Safety discrete on/off output;
- Display LCD, TFT, 800x480 pixels, 7", touch screen;
- Time and calendar system.



**C405-15M**

### S337-51

Calibration process between one displacement transducer and the data acquisition system C405-15M

AS AN ALTERNATIVE:

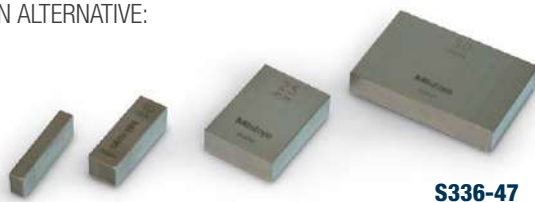

**S336-41 S336-43 S336-45 S336-47**

GAUGE BLOCKS. Grade 1

Used to calibrate the linear displacement transducers.

### AVAILABLE MODELS

- S336-43** Gauge block, nominal length 10 mm
- S336-45** Gauge block, nominal length 25 mm
- S336-47** Gauge block, nominal length 50 mm

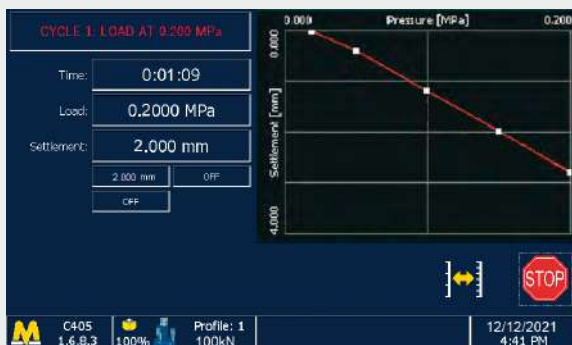

Test execution



Final results and test graph

**S228N****DYNAMIC PLATE LOAD TEST****LIGHT WEIGHT DEFLECTOMETER**

STANDARDS: ASTM E 2835-11 | TP BF-StB part B 8.3 | ZTV E-StB 2017 | RIL 836 | RVS 08.03.04 (Austria)

Used in earthwork and road construction to determine the soil bearing capacity and the compaction quality of soils and non cohesive subbases, as well as for soil improvement applications. The test method is suited for coarse-grain and mixed-grain soil having maximum grain size of 63 mm. The test method may be used to determine the dynamic modulus of deformation of soil in the range  $E_{vd} = 15...70 \text{ MN/m}^2$ .

ADVANTAGES over the static plate load tester:

- Immediate evaluation of each measurement
- Only 2 minutes per measurement point
- Time and cost-saving
- No need for construction plant as kentledge
- Easy to handle by one person
- Ability to test in inaccessible locations

Being easy to handle and providing immediate measuring results, the Light Weight Deflectometer is additionally suited for monitoring intra-company operations. It facilitates quick decisions for continuing construction work at the site.

SPECIFICATIONS:

- Measuring instrument - small, portable and precise
- Intuitive menu navigation with 10 selectable languages
- Variable text input and pre-loading pulses
- Three settlement values shown during test
- Settlement mean value and  $E_{vd}$  modulus automatically calculated
- Drop weight: 10 kg (extendable to 15 kg)
- Measure range:  $E_{vd} 15-70 \text{ MN/m}^2$  (extendable to  $105 \text{ MN/m}^2$ )
- Measure depth: 600 mm
- Load plate  $\varnothing 300 \text{ mm}$
- SD card for storage of 10.000 data tests
- Up to 1.500 tests with just one set of batteries (4xR6)
- High quality zinc plated galvanization of metallic parts, against corrosion

The tester is supplied complete with loading unit, load plate, measuring instrument with SD card and instructions (in weatherproof full leather carrying case)

**Total Weight:** 30 kg approx.



**S228-14**

**ACCESSORIES**

- S228-05** DROP WEIGHT of 15 kg. Measuring range of  $70-105 \text{ MN/m}^2$ .
- S228-10** PROTOCOL SOFTWARE. Add information about the measuring point and use the comfortable user interface for issuing and easy-view archiving of representative A4-protocols.
- S228-11** THERMAL PRINTER in case (with power battery, power supply and connection cable)
- S228-12** INTEGRATED GPS SYSTEM. To proof the exact coordinates of the measuring point.
- S228-13** TRANSPORT CART. For long distances at the site.
- S228-14** MAGNETIC STAND. For proper positioning of loading unit.
- S228-15** TRANSPORT BOX. For safe transport and storage.
- S228-06** WI-FI SD CARD. Fast data transfer to mobile, phone, tablet or PC. Free mobile apps for both Android and iOS.



**S228-13**



**S228N**

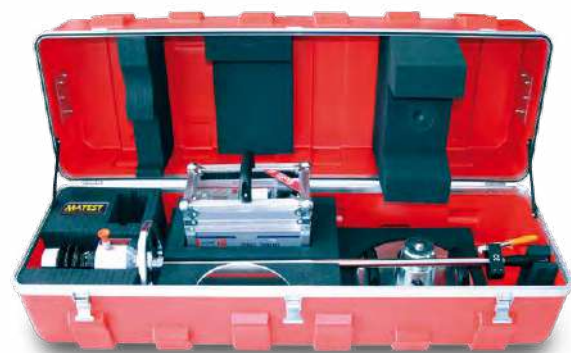

**S228-15**

## RELATIVE DENSITY OF COHESIONLESS SOIL

### VIBRATING TABLE METHOD

The relative density set is proposed in two versions according to EN or ASTM Specifications:

#### S238N KIT

### RELATIVE DENSITY OF COHESIONLESS SOILS

STANDARD: EN 13286-5

This test covers the determination of the maximum dry density and the water content (humidity/density ratio) of cohesionless mixtures where the max density by the impact method is lower than the vibratory method.

The method is applicable to materials containing up to 12% fines (< 0.063 mm) by mass and max. particle size is 80 mm.

The test is performed to road construction mixtures.

The set is composed of:

**S238-10** Vibrating electromagnetic table, dimensions 762x762 mm, vibration frequency 3600 rpm, amplitude range: 0.05 to 0.64 mm, max. load capacity 250 kg, complete with separate control panel.

**Power supply:** 230V 1ph 50-60Hz

**S238-11EN** Relative density mould 14 liters capacity with accessories.

**S238-12** Surcharge weight and base with handle to EN for the 14 liters mould.

**Total weight:** 290 kg approx.

#### S238-01N KIT

### RELATIVE DENSITY OF COHESIONLESS SOILS

STANDARDS: ASTM D4253, D4254

The method is applicable for the determination of the relative density of cohesionless soil where impact compaction will not produce a well defined moisture/density relationship curve.

The maximum density of the impact test is normally less than the vibratory method.

The set is composed of:

**S238-10** Vibrating electromagnetic table, as above described. Power supply: 230V 1ph 50-60Hz

**S238-11N** Relative density mould 0,5 cu. ft. capacity with accessories.

**S238-13N** Relative density mould 0,1 cu. ft. capacity with accessories.

**S238-14N** Surcharge weight and base with handle to ASTM for the 0.5 cu. ft. mould.

**S238-15N** Surcharge weight and base with handle to ASTM for the 0.1 cu. ft. mould.

**S238-16** Relative density gauge measuring set.

**Total weight:** 310 kg approx.

#### ACCESSORY

**S238-17** Pouring devices  
Ø 12.5 and 25 mm



**S238-17**

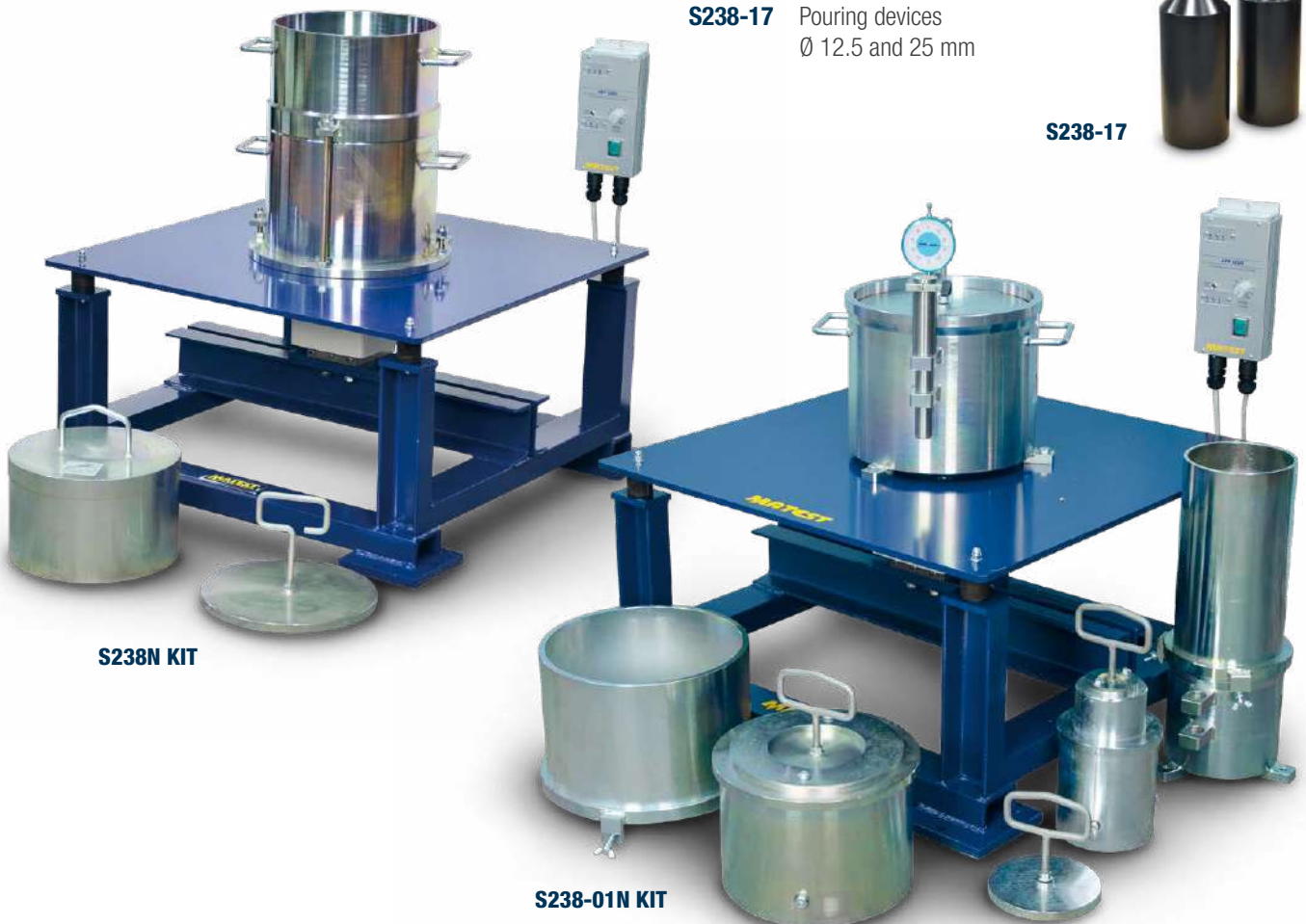

**S238N KIT**

**S238-01N KIT**

## S230 KIT ASTM | AASHTO BALLOON DENSITY APPARATUS 1600 ML CAPACITY

STANDARDS: ASTM D2167 | AASHTO T205 | CNR N° 22

Used to determine the in-situ density of fine graded compacted or bonded soil. The apparatus is placed over the hole excavated in the soil, and water is pumped into a rubber balloon and forced into the hole. The amount of water displaced into the ballon is measured from the graduation of the scale.

The instrument consists of a graduated plexiglass cylinder 1600 ml capacity housed within an aluminium alloy casting, a rubber pump with stop valve, a density plate and 12 rubber balloons.

**Dimensions:** 340x340x700 mm

**Weight:** 6 kg approx.

### SPARE

**S230-01** Rubber balloons, pack of 12



**S230 KIT**

## S232 KIT NF BALLOON DENSITY APPARATUS

3000 ML CAPACITY

STANDARD: NF P94-061-2

Used to determine the in-situ density of fine graded compacted or bonded soil, this unit has the same test system of mod. S230 KIT, but with a capacity of 3000 ml as requested by French Specification. A hand-driven piston forces the water into the rubber membrane. A dial gauge measures the water pressure so to execute all the test at the same pressure.

An index engraved on the stem of the piston measures the volume of water filling the hole.

The unit is supplied complete with 6 reinforced rubber membranes, 4 locking clamps, base plate, accessories.

**Dimensions:** 360x360x700 mm

**Weight:** 10 kg approx.

### SPARE

**S232-01** Reinforced rubber membrane, pack of 6



**S232 KIT**

**S233 KIT**

## S233 KIT NF BALLOON DENSITY APPARATUS

6000 ML CAPACITY

Identical to mod. S232 KIT, but with capacity of 6 litres.

**Weight:** 15 kg approx.

### SPARE

**S233-01** Reinforced rubber membrane, pack of 6

### ACCESSORIES

Used for levelling, digging, collecting and maintaining the soil samples:

<b>S240-01</b> SCRAPER to level the ground	<b>V198</b> CHISEL 300 mm long x 25 mm wide
<b>S240-02</b> METAL DIBBER TOOL	<b>V186</b> DENSITY SPOON, big sized
<b>S240-05</b> METAL POINTED ROD	<b>V188</b> TROWEL, 100x200 mm
<b>V195</b> RUBBER MALLET Ø 50 mm	<b>V183</b> ALUMINIUM SCOOP 325 cc
<b>V193</b> STEEL HAMMER 300 g	<b>V125-03</b> TINNED CAN 5 litre cap.
<b>V194</b> STEEL HAMMER 2 kg	
<b>V199</b> DENSITY PICK	



**S240-01...V199**

## FIELD DENSITY SAND REPLACEMENT METHOD

STANDARDS: ASTM D1556 | AASHTO T191 | NF P94-061-3 | CNR N° 22 | UNE 7371

Used to determine the in-situ density of fine grained compacted soil and to verify the degree of compaction.

The test consists in digging a hole into the ground and then collect, dry and weight the sampled soil.

The hole is now filled with dry sand from the cone container and the volume of sand recorded.

Three versions are available Ø 4" 6.5" 12" each one suitable for different grain sized.

The S231KIT model Ø 12" is recommended for coarse grained soil and gravel (over 38 mm diameter).

The kit consists of:

- Metal double cone assembly with valve, galvanized for rust protection.
- Metal base with rimmed centre hole for cone housing, galvanized.
- Two plastic jar, 5 litre capacity. (One jar only 15 litre capacity complete of cone fixing device for S231 KIT version)

The calibrating container is an accessory, to be ordered separately.



Model	Diameter inch / mm	Double cone with valve	Metal base with hole	Jar plastic	Dimensions mm	Weight kg	Calibrating container (optional accessory)
<b>S234-10 KIT</b>	4" (101.6 mm)	<b>S234-11</b>	<b>S234-12</b>	<b>V121</b> (2)	190x190x500	2.300	<b>S234-13</b>
<b>S234 KIT</b>	6.5" (165.1 mm)	<b>S234-05</b>	<b>S234-06</b>	<b>V121</b> (2)	305x305x600	3.350	<b>S234-01</b>
<b>S231 KIT</b>	12" (304.8 mm)	<b>S231-05</b>	<b>S231-06</b>	<b>S231-11</b> (1)	620x620x920	13.600	<b>S231-01</b>

 **Note:** all parts can be purchased individually.

### ACCESSORIES

**S235N** STANDARD SAND for density tests, passing 600 micron and retained on 300 micron. ASTM, AASHTO, BS. Bag of 25 kg.

**S235-01N** STANDARD SAND, passing 0.4 mm and retained on 2 mm. CNR N° 22. Bag of 25 kg



## BS SAND REPLACEMENT APPARATUS

STANDARDS: BS 1377:9, BS 1924:2

Used to determine the in-situ density of fine grained compacted soil.

The apparatus consists of: sand pouring cylinder with shutter made of cast aluminium and accurately machined, upper cylinder, metal tray with fixed centre hole for cone housing.

The cylinder is available with 100, 150 and 200 mm diameter ( $\emptyset$  200 mm is recommended for coarse grained soil and gravel).



**S236 KIT...S237 KIT**

Available Models	$\emptyset$ mm	Pouring cylinder, shutter and upper cylinder	Metal tray with centre hole	Optional accessory: Calibrating container	Weight of the complete KIT
<b>S236 KIT</b>	100 Consisting of:	<b>S236-05</b>	<b>S236-06</b>	<b>S236-07</b>	kg 10.800
<b>S236-01 KIT</b>	150 Consisting of:	<b>S236-10</b>	<b>S236-11</b>	<b>S236-12</b>	kg 14.150
<b>S237 KIT</b>	200 Consisting of:	<b>S237-05</b>	<b>S237-06</b>	<b>S237-07</b>	kg. 22.600

## S244 PINHOLE TEST EQUIPMENT

### DISPERSIBILITY DETERMINATION

STANDARDS: ASTM D4647 | BS 1377:5

Utilized to evaluate the erosion on soil samples having high degree of sodium content, the Pinhole apparatus reproduces the water flowing in a cavity obtained from a soil specimen.

The apparatus consists of a cylindrical container equipped at its ends of water inlet/outlet connectors, tube with graduated scale, base support with rod.

**Weight:** 4 kg approx.

### ACCESSORIES

**S245-04** CONSTANT LEVEL TANK. Details and picture: see p. 526

**V230-02** TUBING, inside  $\emptyset$  8 mm, 5 m long



**S244**



## CONSTANT HEAD PERMEAMETERS

STANDARDS: BS 1377:5 | ASTM D2434 | AASHTO T215

Used to determine the permeability of granular, gravel and sand soils. The specimen is formed in an acrylic permeability cell, and water is passed through it from a constant level tank.

The permeability cell has pressure points at different levels which are connected to the manometer tubes fixed on a stand with graduated scale. Two constant head permeability cells are available: 75 mm and 114 mm diameter.



### S245-01

#### CONSTANT HEAD PERMEABILITY CELL Ø 75 MM

with three pressure take-off points.

Formed by an acrylic plexiglass body held between two aluminium anodized end plates.

**Weight:** 3 kg approx.

### S245-02

#### CONSTANT HEAD PERMEABILITY CELL Ø 114 MM

with six pressure take-off points and an additional six blanked-off pressure points. Formed by an acrylic plexiglass body held between two aluminium anodized end plates. When using this cell, two manometer tube stands mod. S245-03 are required.

**Weight:** 7 kg approx.

### S245-03

MANOMETER TUBES AND STAND, comprising three tubes of constant bore, graduated scale, tubing and connectors.

**Dimensions:** 210x50x1160 mm

**Weight:** 5 kg approx.

### S245-04

CONSTANT LEVEL TANK, made from acrylic plexiglass, wall mounting. The inlet, outlet and overflow pipes can be adjusted for height within the tank.

**Weight:** 3 kg approx.

## FALLING HEAD PERMEAMETER

STANDARD: CEN ISO/TS 17892-11

Used to determine the permeability of fine-grained soils such as clay-like or silty soils. The specimen is confined within the permeameter which is connected to the manometer tube filled with water. The sample must be completely saturated with water before the test, and the operator will check the rate of fall of the water in the tube passing through the test specimen.

The set consists of:

### S246-01

Permeameter stand with three manometer tubes each Ø 3, 4 and 6 mm for the different degrees of permeability, soaking reservoir with cock, tubing and connectors.

**Dimensions:** 1700x220x50 mm

**Weight:** 10 kg approx.

### S252

#### COMPACTION PERMEAMETER

Ø 4" complete

(technical details: see next page)

ALTERNATIVE:

### S253

#### COMPACTION PERMEAMETER

Ø 6" complete.



## ACCESSORIES for Compaction Permeameters Ø 4"

**S252-01** PLEIN BASE and COLLAR Ø 4" for compaction tests.

**S252-02** MOULD BODY Ø 4" with two lateral water inlet/outlet.

## ACCESSORIES for Compaction Permeameters Ø 6"

**S253-01** PLEIN BASE and COLLAR Ø 6" for compaction tests.

**S253-02** MOULD BODY Ø 6" with two lateral water inlet/outlet.

## ACCESSORIES

**S355** DE-AIRING TANK 20 litre capacity made from acrylic plexiglass (see p. 550)

**S355-01** WATER TRAP to collect the water condensation.

**V203** PORTABLE VACUUM PUMP, 230V 1ph 50Hz

**V230-03** RUBBER TUBING for vacuum, 3 m long.

**S325** NYLON TUBING, 20 m

## S248 PERMEAMETER STAND 4 CELL CAPACITY FOR CONSTANT AND FALLING HEAD TESTS

This 4 cells capacity stand is designed to perform both constant head and falling head permeability tests on compacted granular soil samples.

The stand consists of a metal frame with water tank adjustable in height between 1350 and 3450 mm for constant head tests. Supplied complete with tubes, graduated rules, piping, connectors and cocks; but without permeameters to be ordered separately.

The stand can hold up to 4 permeameters having  $\varnothing$  4" or 6" to perform different types of tests at the same time.

**Dimensions:** 1050x900x2000/3850 mm

**Weight:** 75 kg approx.

## COMPACTION PERMEAMETERS

STANDARD: CEN ISO/TS 17892-11

Used for determining permeability to water of soil gravel, clay, sand samples. Supplied complete with clamped upper and lower plate giving the possibility to perform permeability tests also on compacted samples, water inlet with valve, water outlet, two perforated upper and lower plates, two stainless steel screens. Steel made, galvanized against corrosion.



S253

S253 disassembled

### MODELS

**S252** COMPACTION PERMEAMETER  $\varnothing$  4" complete.

**Weight:** 8 kg approx.

**S253** COMPACTION PERMEAMETER  $\varnothing$  6" complete.

**Weight:** 16 kg approx.

### ACCESSORIES for S252

**S252-01** PLEIN BASE and COLLAR for compaction test before the permeability test

**S252-02** MOULD BODY with two lateral water inlet/outlet for test with piezometric measurement

### ACCESSORIES for S253

**S253-01** PLEIN BASE and COLLAR for compaction test before the permeability test

**S253-02** MOULD BODY with two lateral water inlet/outlet for test with piezometric measurement



S248 + Permeameters



S252-02

S252-02

S252-01

S253-01

### ACCESSORIES

CUTTING COLLAR, coupled to the Permeameter body, it gets easier the soil sampling.

### MODELS

**S185-01**  $\varnothing$  4" cutting collar

**S200-09**  $\varnothing$  6" cutting collar



S200-09

## CONSOLIDATION TEST

STANDARDS: ASTM D2435, D3877, D4546 | BS 1377:5  
 AASHTO T216 | XP P94 090-1, P94-091  
 UNE 103-405, 103-602

The one-dimensional consolidation test of a soil sample enables to ascertain the settlement characteristic over a given period of time. The soil specimen under test is axially loaded and laterally contained.

Loads are applied with progressive increases and the settlement values are read on a dial gauge or on a digital display (through a displacement transducer).

Two different oedometer models are proposed:

**S260** Front loading oedometer with dial gauge or digital data acquisition system.

**S262N** Edotronic, pneumatic, fully automatic touch-screen consolidation apparatus (see next pages).

### S260

#### FRONT LOADING OEDOMETER CONSOLIDATION APPARATUS

Rigidly manufactured from aluminium alloy casting to provide a high degree of accuracy with any frame distortion under load. The load bridge group is supported in high accuracy self-aligning seat balls. The beam provides three loading ratio: 9:1 10:1 11:1 and the beam assembly is fitted with an adjustable counterbalance weight.

Maximum load: 170 kg of slotted weights, corresponding to 1870 kg using the beam ratio 11:1

The oedometer accepts cells up to 100 cm<sup>2</sup>

Supplied complete with rod holding the weights and coupling block holding the dial gauge or transducer.

Supplied **without**: consolidation cell, weights, dial gauge (or transducer), holding bench which have to be ordered separately.

**Weight:** 25 kg approx.

#### ACCESSORIES

**S376** DIAL GAUGE 10 mm travel x 0.01 mm subdiv. for vertical displacements.

or:

**S375-01** DIAL GAUGE 12 mm travel x 0.002 mm subdiv.

Alternative solution:

**S336-11** LINEAR VERTICAL DISPLACEMENT TRANSDUCER, 10 mm travel

**S336-30** EXTENSION CABLE 2 metres long, or:

**S336-31** EXTENSION CABLE 5 meters long, or:

**S336-32** EXTENSION CABLE 10 meters long

### S337-51

CALIBRATION process of the displacement transducer to the data acquisition unit of the oedometer.

**S260**  
with cell and dial gauge



**S265**

**S336-11**



**S334**

**S260** with cell and S334 Cyber-Plus 8 Evolution

### S334

#### CYBER-PLUS 8 EVOLUTION

8 channels acquisition and processing data system (expandable to 16 channels) colour "Touch Screen" display, it automatically performs test and data processing. Directly connected to PC via USB, it prints the test certificate. Equipped with slots for external Pendrive or SD Card infinite memory supports.

Technical details: see p. 559, Hardware details at p. 18

### S260-05N

Software OedoLab Reports - MATEST MADE

Technical Data: see p. 531

## CONSOLIDATION CELLS - FIXED RING

Made from **brass**, with specimen holding fixed ring having cutting rim so as to be utilized also to sample undisturbed specimens. Accurately manufactured these cells are supplied complete with loading piston, couple of porous stones and plexiglass transparent water jacket.

Model	Specimen diameter mm	Specimen area cm <sup>2</sup>	Specimen thickness mm	Spare cutting ring mm	Specimen tamper	Spare of porous stones	
						Upper	Lower
S268	50,47	20	20	S122	S123	S274U	S274L
S268-05	63,5	31,67	20	S122-19	S123-05	S274-10U	S274-10L
S268-01	71,40	40	20	S122-01	S123-01	S274-01U	S274-01L
S268-04	75,00	44,16	20	S122-17	S123-04	S274-09U	S274-09L
S268-02	79,80	50	20	S122-02	S123-02	S274-02U	S274-02L
S268-03*	112,80	100	25	S122-03	S123-03	S274-03U	S274-03L

\* The consolidation cell Ø 112.8 mm is made from aluminium.



## CONSOLIDATION CELLS - PERMEABILITY ATTACHMENT

Made from **brass**, similar in manufacture to the fixed ring cells, they are also provided of a pipe connector with cock and graduated glass burette 10 ml capacity allowing to perform permeability tests.

Model	Specimen Ø mm	Specimen area cm <sup>2</sup>	Specimen thickness mm	Hollow punch	Specimen tamper	Spare of porous stones (1 pc)
S272	50.47	20	20	S122-04	S123	S274-04U
S272-05	63.5	31.67	20	S122-20	S123-05	S274-10U
S272-01	71.40	40	20	S122-05	S123-01	S274-01U
S272-04	75.00	44.16	20	S122-18	S123-04	S274-09U
S272-02	79.80	50	20	S122-06	S123-02	S272-02U
S272-03*	112.80	100	25	S122-07	S123-03	S274-03U

\* The consolidation cell Ø 112.8 mm is made from aluminium.

### S275 PERMEABILITY ATTACHMENT

Complete with stand, clamps and hose it is connected to the cells mod. S272 to S272-05.

Recommended for soil samples having great value of permeability.

Burette has 50 ml capacity and subdiv. 0.1 ml.

**Weight:** 5 kg approx.

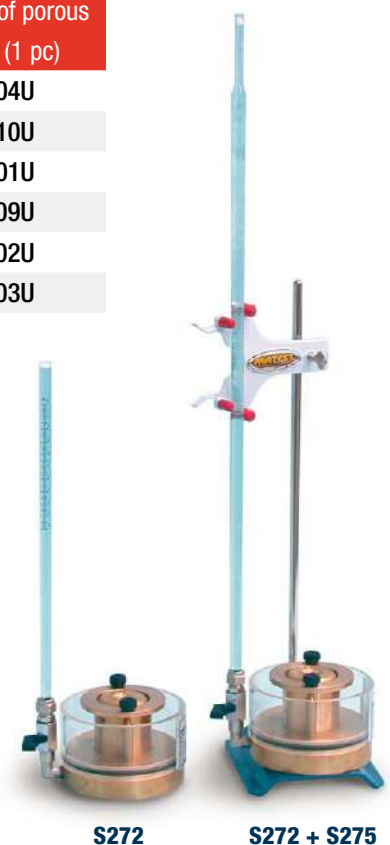

**OEDOMETER: ACCESSORIES**
**SLOTTED WEIGHTS**

Steel made, painted against corrosion (mod. E066-02 brass made).

Available slotted weights:

Model	Weight	Model	Weight
E066-02	100 g	S273-07	4 kg
S273-06	250 g	S273-02	5 kg
S273-05	500 g	S273-08	8 kg
S273-04	1 kg	S273-01	10 kg
S273-03	2 kg		

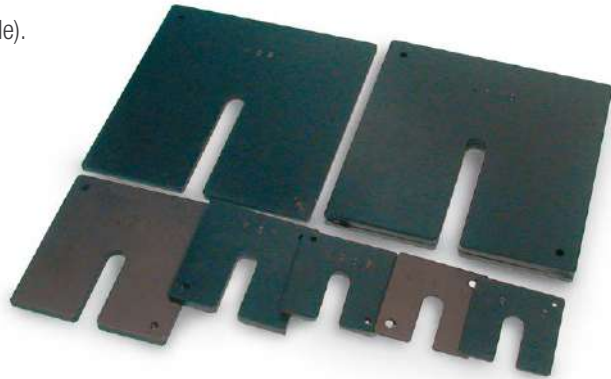
**KIT OF SLOTTED WEIGHTS**

S273 KIT	S273-01 KIT	S273-02 KIT
S273-01 = 4x10 kg	S273-08 = 7x8 kg	S273-01 = 6x10 kg
S273-02 = 1x5 kg	S273-07 = 1x4 kg	S273-02 = 3x5 kg
S273-03 = 2x2 kg	S273-03 = 1x2 kg	S273-03 = 1x2 kg
S273-04 = 1x1 kg	S273-04 = 1x1 kg	S273-04 = 1x1 kg
	S273-05 = 1x500 g	S273-05 = 3x500 g
	S273-06 = 2x250 g	S273-06 = 2x250 g
<b>TOTAL: 50 kg</b>	<b>TOTAL: 64 kg</b>	<b>TOTAL: 80 kg</b>

**HOLDING BENCH**, made from sturdy structural painted steel, complete with locking bolts and nuts.

- S265** BENCH HOLDING one apparatus  
**S265-01** BENCH HOLDING three apparatuses

**S265**
**GAUGE BLOCKS**
**GRADE 1**

Used to calibrate the linear displacement transducers.

**AVAILABLE MODELS**

- S336-41** GAUGE BLOCK, nominal length 5 mm  
**S336-43** GAUGE BLOCK, nominal length 10 mm

**S336-43**
**S336-41**
**SPARES**

- S335-15** Universal coupling pliers for dial gauge/transducer. It accepts all Matest displacement transducers and dial gauges (Ø from 8 to 20 mm)  
**S260-13** Mounting device between the universal coupling pliers S335-15 and the consolidation apparatus to fix the transducer/dial gauge for the vertical displacement.

**S336-30**
**S336-11**
**S335-15**
**S260-13**

**S260-05N**  
 Data import from the CyberPlus

## S260-05N SOFTWARE OEDOLAB REPORTS

STANDARDS: ASTM D2435-80 | XP P94-090-1 | BS 1377:5

OedoLab Reports is the new informatic tool which allows geotechnical laboratories to process data and to view the results obtained from oedometric tests.

Used in conjunction with Cyber-Plus S334, the new features of this software allow the users to:

- Create a test file from data entered manually or imported
- Create a project to perform calculations according to the selected standard
- Integrate test files (from OedoLab Connect or manually entered) to a project
- Elaborate, customize and print their test reports which can be read without the need of a specific software.

The program can be used in a very simple and intuitive way. A dedicated window allows the user to import data from a specific location (for instance, from the Cyberplus through USB or SD card).

OedoLab Reports provides the user with a simple and flexible graphical interface giving the possibility to view, edit and print all the parameters involved in the oedometric tests.

The input information for each stress level is the following:

- Settlements in mm.
- Time in min.

The Software allows also to enter information related to the soil sample, among which:

- Extraction method.
- Blue value.
- Atterberg's limits.
- Soil classification according to AASHTO/USCS/GTR.
- Particle size analysis.

Laboratory coefficients of:

- Consolidation – root method.
- Void ratio.
- Water content.
- Densities.
- Compressibility.

CHARTS:

- Settlements (mm) / Time (min).
- Void ratio (%) / Applied pressure (kPa).
- Passing (%) / Opening (mm).

PC specification:

- Operating system: Windows XP or more recent

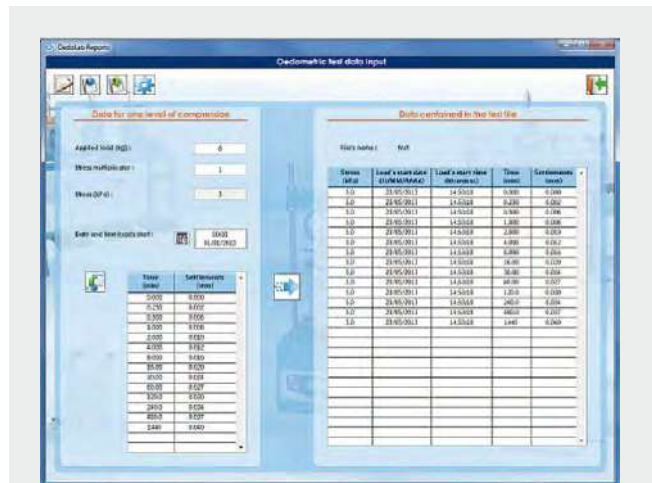

S260-05N Data feeding/acquisition



S260-05N Test data visualization



S260-05N Results preview

**BUYER'S GUIDE FOR ONE STANDARD CONSOLIDATION SYSTEM AND ONE AUTOMATIC CONSOLIDATION DATA ACQUISITION/PROCESSING SYSTEM.**
**S260**  
 with accessories

**S265-01**

**S334**

Configuration for one standard Oedometer apparatus	Model
Front loading oedometer	S260
Oedometer bench (for one or three oedometers)	S265 / S265-01
Dial gauge	S376 / S375-01
Consolidation cell, fixed ring	S268 / S268-05
Spare cutting ring (to combine to the consolidation cell)	S122 / S122-19
Specimen tamper (to combine to the consolidation cell)	S123 / S123-05
Spare porous stones (to combine to the consolidation cell)	S274 / S274-10
Set of slotted weights	S273 / S273-10
Permeability measurement:	
Permeability consolidation cell	S272 / S272-05
Permeability attachment (50 ml burette)	S275
Hollow punch (to combine to the consolidation cell)	S122-04 / S122-20
Spare porous stones (to combine to the consolidation cell)	S274-04 / S274-11

Configuration for one Oedometer apparatus with electronic measurement and data acquisition/processing:	Model
Oedometer with accessories as listed in the standard configuration (without the dial gauge S376), and also:	
Cyber-Plus 8 Evolution, 8 channels (expandable to 16 channels) automatic data acquisition/processing	S334
Displacement transducer (in quantities as the oedometers)	S336-11
Extension cable (in quantities as the transducers)	S336-30 / S336-32
Software OedoLab Reports - Matest made	S260-05N
Gauge blocks to calibrate the transducers	S336-41 / S336-43
or:	
Transducer / Oedometer calibration process	S337-51

**S261****EDOMEC****AUTOMATIC CONSOLIDATION APPARATUS (OEDOMETER)**

ADVANCED ELECTROMECHANICAL SYSTEM

STANDARDS: BS 1377:5 | ASTM D2435, D3877, D4546 | AASHTO T216 | NF P94-090-1, NF P94-09

This automatic consolidation system, ideal for modern and efficient laboratories, has been developed to eliminate or reduce to the absolute minimum any forms of manual intervention, which the oedometer test.

This machine has innovative technology for controlling the application of loads. The load application system is guaranteed by a sophisticated PID electromechanical system. It is able to control load very accurately, thanks to the high frequency control up to 1kHz. This allows high precision at low loads, high speed of load application at high loads.

The test is configured using a special test icon, in which it is possible to set loads and acquisition times; both the loads and the acquisition times are freely configurable. The large display makes it easy to visualize test data and graphs.

**Frame Specifications:**

- Standard load cell :10kN (up to 25 kN on request )
- Precision: 0.15 % at full range
- Ram travel: up to 25 mm
- Minimum speed: 0.00001 mm/min
- Maximum speed: 99.99999 mm/min
- Control frequency: up to 1 kHz
- Horizontal clearance: 175 mm
- Vertical clearance: 185 mm (without extension columns)  
265 mm (with extension columns)
- Maximum cell size dia: 112.8 mm
- Safety function for automatic machine stop when maximum load or maximum strain/deformation is reached.

**Firmware:**

- Equipped with 8 channels, suitable for connection of load, displacement, deformation, LVDT, temperature (PT100, PT1000, NTC) and strain gauge (by using an external adapters) transducers.
- Semi-automatic configuration and calibration of all transducers connected.
- Automatic calculations and real time display of graphs and results according to the Standard.
- The digital controller (PC) works on Windows CE based system and can be easily updated through the USB with no need to uninstall or move the controller.
- Sampling frequency of 2 kHz with a selectable sampling rate between 1 Hz and 20 Hz (5 levels).
- Unlimited memory storage with: 2 USB ports, 1 SD card. Ethernet port for remote control through PC.

**MAIN FEATURES**

- Automatic calculations and real time display of graphs and result according the standard.
- Maximum vertical force: up to 25 kN
- Minimum speed: 0.00001 mm/min  
Maximum speed: 99.99999 mm/min
- 8 channels for acquisition and data processing system.
- Sampling frequency of 2 kHz with a selectable sampling rate between 1 Hz and 20 Hz

**S261****ACCESSORIES**

- S262-12N** SOFTWARE OEDOLAB CONNECT - MATEST MADE
- S336-11** LINEAR DISPLACEMENT-DEFORMATION
- S337-51** CALIBRATION PROCESS of the linear displacement transducer combined with the Edotronic.
- S268/S272-05** CONSOLIDATION CELLS, different models:  
see p. 529



## S262-12N SOFTWARE OEDOLAB CONNECT

STANDARD: ASTM D2435-80 | XP P094-090-1 | BS 1377:5

To be used with the Edotronic mod. S262

OedoLab Connect is an extension of the OedoLab Reports S262-05N software, specifically designed to guide the user through the entire consolidation test.

This software allows automatic data acquisition and to save the results in a specific file.

Thus, the file obtained can be then added to a project created with OedoLab Reports, providing the users not only with the same features given by the S262-05N but also with new ones.

OedoLab Connect can be connected to one or more pneumatic oedometers, allowing automatic data acquisition and control during the test. Each oedometer is controlled by the PC via network connection.

OedoLab Connect provides the user with a simple and flexible graphical interface. A dedicated window allows to select the oedometer the user wants to work with.

Once a consolidation step is completed, the software automatically shifts to the next level; hence re-performing all the control and acquisition operations needed to complete the test. Furthermore, by setting test parameters which are included in the Software and dedicated to the loading sequences control (minimum speed of settlement and swelling threshold), the user is also able to program the test and save a lot of time then.

PC specification:

- Operating system: Windows XP or more recent.
- Supplied complete with connection cable.



S262-12N Test view

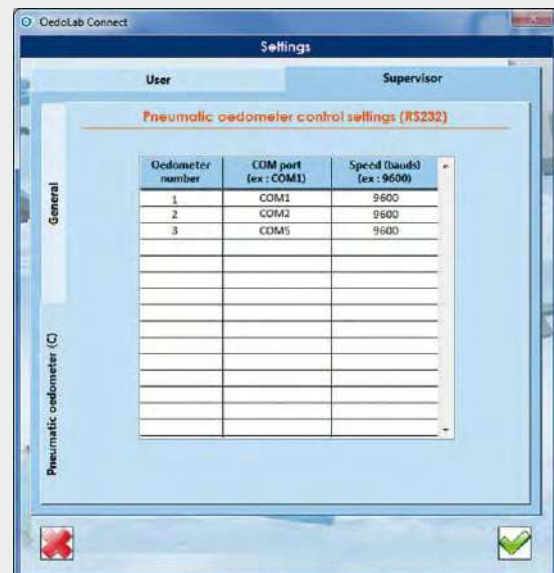

S262-12N Control settings

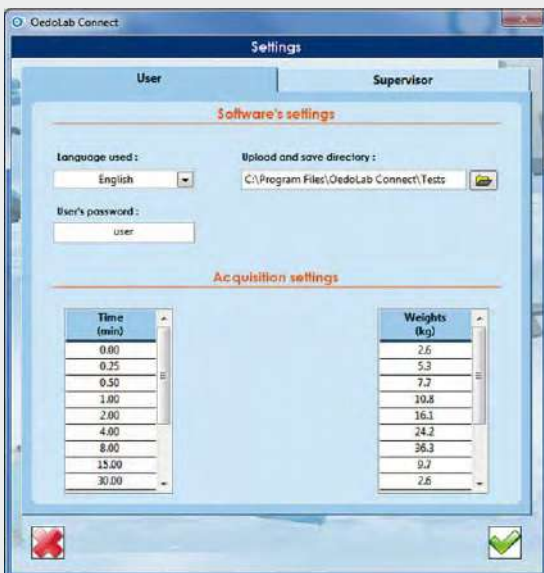

S262-12N Acquisition settings



S262-12N Information about the test



S262-12N Modularity View



S334-12

S334-11

Oedolab Connect S262-12N allows automatic data acquisition and control for each oedometer configured into the dedicated Pneumatic Oedometer control settings window (see above image).

This way, up to 24 units can be connected to the same PC by using an Ethernet network, providing modern geotechnical laboratories with a powerful tool to control single or multiple units at choice.

## ACCESSORIES

**S334-11** Network connection RS45 cable

**S334-12** Switch to connect from 2 to 7 Cyber-plus units to the Ethernet Network

## DIRECT / RESIDUAL SHEAR TEST APPARATUS, DIGITAL TOUCH-SCREEN

STANDARDS: ASTM D3080 | BS 1377:7 | NF P94-071-1, NF P094-071-2 | AASHTO T235 | CEN-ISO-TS 17892-10

This apparatus is used to determine the resistance to shearing of all types of soil specimens including both consolidated and drained, undisturbed or remolded. The machine can accommodate round specimens  $\varnothing$  50, 60, 63.5, 100 mm and square 60x60, 10x100 mm.

The machine has an integral closed loop control motor with epicycloid reducers.

At the beginning of each test the machine performs an automatic and complete internal check including a position reset resulting in the elimination of all position errors.

A user-friendly microprocessor controlled touch screen is used to input all test patterns providing an efficient and flexible interface.

(All data are input and stored when the machine is in stand-by, without affecting the specimen under test with quick machine setting.)

Facility for shear box maximum extension detection, to automatically stop the test.

Facility to input a different return speed (residual shear) in relation to the one used for the shear test, thus allowing a quick playback of the residual shear test, saving a lot of time.

The effects of the primary consolidation can be identified directly on the consolidation curve, only with data acquisition version. Automatic calculation of the appropriate shear velocity with selection of optimal consolidation parameters for t50, t90 and t100 (only with data acquisition version). This provides efficiency and cost effectiveness.

### Frame Specifications:

- Maximum shear load: 5000 N possible on the whole speed range.
- Shear speed: 0.00001 to 15,0000 mm/min.
- Display of both speed and displacement with 0.00001 mm resolution.
- Possibility of direct vertical load, or with a lever arm ratio 10:1
- Max vertical direct load: 500N; lever arm: 5500N
- Box group mounted on ball track with high quality antifriction system.
- Extremely easy and practical use, not requiring qualified staff.

### Firmware:

- Electronic control unit Cyber-plus Evolution with Touch-Screen color graphic display ¼ VGA, that runs like a standard PC based on Windows operating system, for the management of the data. (Analysis of the data, test results, graphs with S277-40N Software; optional accessory).
- The Touch-Screen icon interface allows an easy set-up of all the parameters and prompt execution of the test. Read value results are immediate and of extreme accuracy.
- The machine can perform the tests without any external PC, because of the Cyber-Plus grants performances like a PC.
- Direct connection to Intranet (connection to a LAN network) and Internet to establish a remote communication and receive an immediate diagnosis from Matest technicians, or for upgrades of the Firmware.
- Unlimited memory storage with: 2 USB ports, 1 SD card.
- Possibility to select different languages.
- Hardware technical details: see page 24
- The machine is equipped with 8 connectors for the acquisition and data processing system (3 analogical/digital channels are activated with the S277-31 optional firmware for load cell and transducers; and 5 channels can be activated with the S277-32 optional firmware).

**Power supply:** 230V 1ph 50-60Hz 200W

**Dimensions:** 1040x420xh1350 mm

**Weight:** 120 kg approx.



Detail of the 8 connectors

### MAIN FEATURES

- Automatic calculation of the appropriate shear velocity based on optimal consolidation parameters.
- Shear speed: 0.00001 to 15,0000 mm/min
- Different return speed facility for residual shaer test.
- Integral closed loop control motor.
- User-friendly microprocessor controlled touch screen.
- 8 connectors for acquisition and data processing system.



S276 KIT + S284

## THE DIRECT/RESIDUAL SHEAR TESTING MACHINE IS AVAILABLE IN THREE VERSIONS

### S276 KIT

#### **SHEARLAB** DIGITAL BASIC VERSION DIGITAL SHEAR TESTING MACHINE

comprising:

- S276-10** Shear Frame, with digital Touch-Screen microprocessor, complete with beam loading device, shear box case with adaptors, dial gauge supports.
- S370-03S** Load Ring, 3000N capacity with electric safety stop device (load rings of different capacities up to 5000N available on request).
- S377** Dial indicator 25mm x 0.01mm for horizontal displacement.
- S376** Dial indicator 10mm x 0.01mm for vertical displacement.
- S273 KIT** Set of 50 kg of slotted weights.

 **Note:** Shear box, hollow punch, tamper **are not included** and have to be ordered separately (see accessories)

### S276-01

#### **AUTO SHEARLAB** DATA ACQUISITION VERSION DIGITAL SHEAR TESTING MACHINE WITH INCORPORATED DATA ACQUISITION SYSTEM AND BASIC FIRMWARE

comprising:

- S276-10** Shear Frame with digital Touch-Screen microprocessor, complete with beam loading device, shear box case with adaptors, transducers supports.
- S277-20** Load Cell, electric, 3000N capacity, complete with cable.
- S336-11** Linear vertical transducer, 10 mm travel.
- S336-12** Linear horizontal transducer, 25 mm travel.
- S277-31** Firmware activating 3 connectors for basic data acquisition.
- S273 KIT** Set of 50 kg of slotted weights.

 **Note:** Shear box, hollow punch, tamper and Software (see next pages) **are not included** and have to be ordered separately.

### ACCESSORIES

- S277-40N** SOFTWARE SHEAR-LAB REPORTS - **MATEST MADE**  
Technical data: see p. 539
- S277-32** FIRMWARE activating 5 connectors foreseen on the shear frame S276-10. They can be used as data acquisition and processing system for geotechnical tests. Technical data: see S334 p. 559

 **Note:** these 5 channels can be used alternatively (not simultaneously) to the 3 channels of the shear frame.

GAUGE BLOCKS. Grade 1

Used to calibrate the linear displacement transducers (see p. 541)

### SPARES

- S335-15** Universal coupling pliers for dial gauge/transducer. It accepts all Matest displacement transducers and dial gauges ( $\emptyset$  from 8 to 20 mm)
- S280-15** Mounting device between the universal coupling pliers S335-15 and the shear machine to fix the vertical displacement transducer or dial gauge.
- S280-16** Mounting device between the universal coupling pliers S335-15 and the shear machine to fix the horizontal displacement transducer or dial gauge.



**S276-01 + S284**



## ACCESSORIES

SHEAR BOX assemblies, made from brass, accurately machined, complete with carriage, walled round or square hole, base plate, two grids, two perforated grids, two porous stones, adapters to fit the box holder.

Models	Shear box	Spare of porous stones (1 pc)
Round specimens Ø 50 mm	<b>S282</b>	<b>S286-03</b>
Round specimens Ø 60 mm	<b>S283</b>	<b>S286</b>
Round specimens Ø 63.5	<b>S283-01</b>	<b>S286-05</b>
Round specimens Ø 100 mm	<b>S281</b>	<b>S286-04</b>
Square specimens 60x60 mm	<b>S284</b>	<b>S286-01</b>
Square specimens 100x100 mm	<b>S285</b>	<b>S286-02</b>

HOLLOW PUNCH (sample cutter) and TAMPER (extrusion tool)

The hollow punch with cutting rim is used to prepare the soil sample, and the tamper ejects the specimen filling it directly into the shear box without disturbing it.

Models	Hollow punch	Tamper
Ø 50xh 23 mm	<b>S122-08</b>	<b>S123-08</b>
Ø 60xh 23 mm	<b>S122-09</b>	<b>S123-09</b>
Ø 63.5xh 23 mm	<b>S122-21</b>	<b>S123-17</b>
Ø 100xh 23 mm	<b>S122-10</b>	<b>S123-10</b>
Square 60x60xh 23 mm	<b>S122-11</b>	<b>S123-11</b>
Square 100x100xh 23 mm	<b>S122-12</b>	<b>S123-12</b>

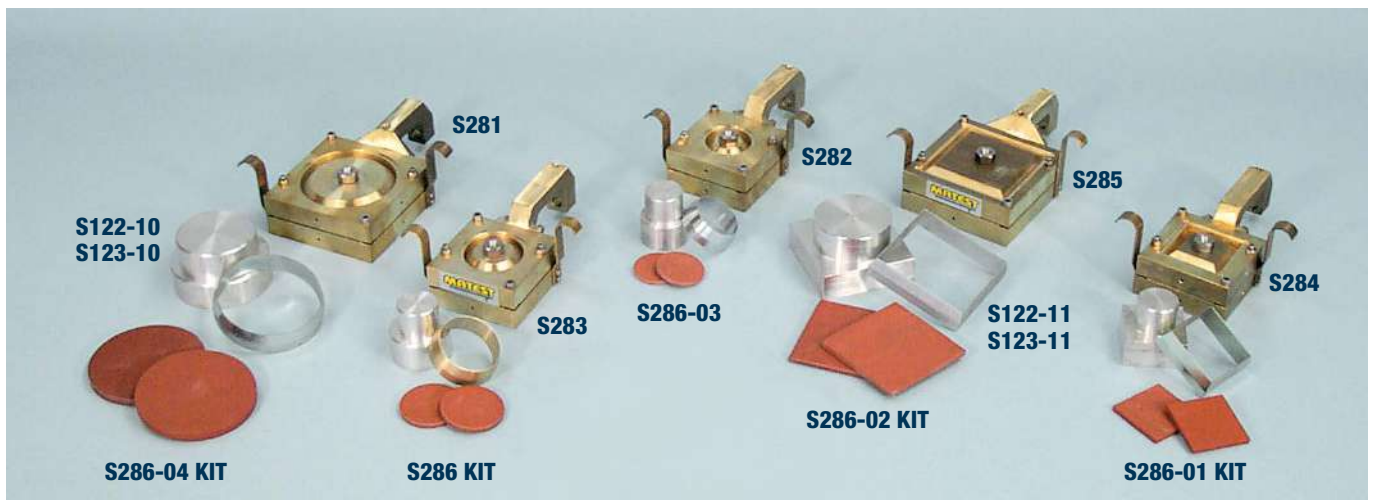

## S290

### CONSOLIDATION FRAME

It accepts up to 3 shear boxes or consolidation cells. Used to apply a constant load on the specimen in the shear box, so as to shorten the test duration when a lot of specimens have to be tested and just few shear machines are available. The frame can also be used to consolidate oedometric cells. Produced in a rugged steel structure, it is supplied complete with three lever arms ratio 10:1 having each max. load up to 550 kg, centering devices and dial gauge holders. Supplied without weights, water container, cells and dial gauges to be ordered separately.

**Dimensions:** 2300x450x900 mm

**Weight:** 150 kg approx.



**S290** with accessories

 **Note:** On request the shear machine can be equipped with load rings or load cells having capacity from 500 N to 5000 N:

## ACCESSORIES for S290

- S291** WATER CONTAINER, made from plexiglass and aluminium, it accommodates the shear box up to max size Ø 60 mm or 60 mm during the consolidation test, by keeping the specimen deep into the water.
- S291-01** WATER CONTAINER, it accommodates all the shear boxes up to Ø 100 mm or 100 mm size.
- S273 KIT** Set of 50 kg of slotted weights
- S376** Dial gauge 10x0.01 mm



**S291-01**

**S291**

## S277-40N SOFTWARE SHEARLAB REPORTS

STANDARDS: ASTM D3080-72 | NF P94-071-1 | NF P94-071-2  
BS 1377:7

To be used with the shear testing machine, data acquisition processing version, mod. S276-01

ShearLab Reports is the new informatic tool which allows geotechnical laboratories to process data and to view the results obtained from direct and residual shear tests.

The new features of this software allow the users to:

- Create a test file from data entered manually or imported
- Create a project to perform calculations according to the selected standard
- Integrate test files to a project
- Elaborate, customize and print their test reports which can be read without the need of a specific software

The program can be used in a very simple and intuitive way. A dedicated window allows the user to import data in the test file.

ShearLab Reports provides the user with a simple and flexible graphical interface giving the possibility to view, edit and print all the parameters involved in shear tests.

### The input information is the following:

- Settlement in mm
- Time in min
- Horizontal displacement in mm
- Force in kN

### In the project management window, the Software automatically calculates the shear parameters:

- Peak strength in kPa
- Residual strength in kPa
- Peak displacement in mm
- Residual displacement in mm

### Laboratory coefficients of:

- Water content
- Densities
- Void ratio

ShearLab Reports automatically draws the curves of shear and compaction, hence performing all the calculations required by the standard. Comments on the current project can also be added if necessary.

### CHARTS:

- Shear stress (kPa) / Horizontal displacement (mm)
- Settlement (mm) / Horizontal displacement (mm)
- Shear strength (kPa) / Normal stress (kPa)

### PC specification:

- Operating system: Windows XP or more recent.
- Supplied complete with connection cable

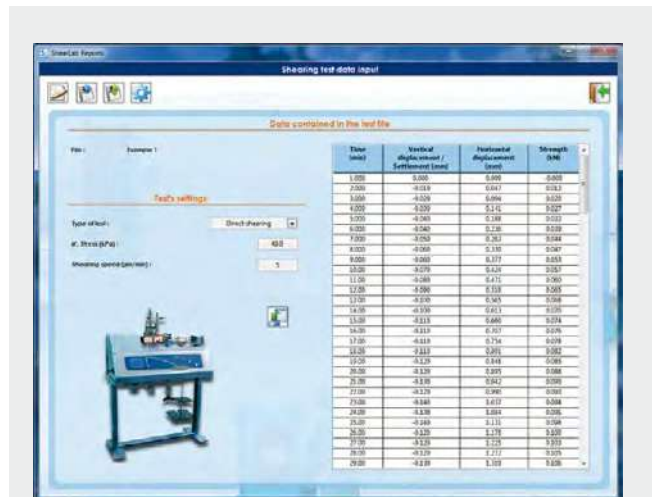

S277-40N Data import



S277-40N Test data calculation

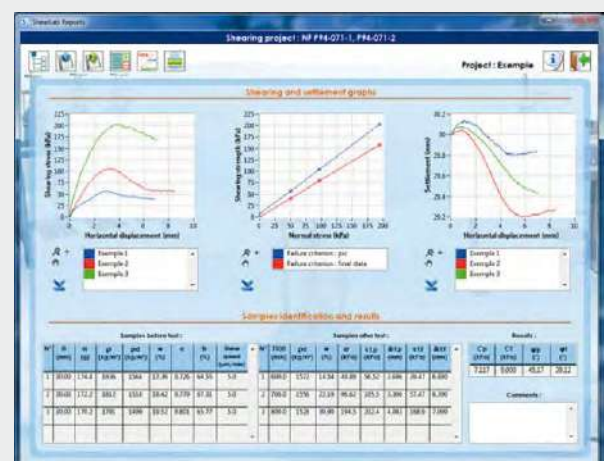

S277-40N Results preview

S276-02

**SHEARTRONIC**
**DIGITAL SHEAR TESTING MACHINE WITH INCORPORATED DATA ACQUISITION SYSTEM AND PNEUMATIC VERTICAL LOADING DEVICE - FULLY AUTOMATIC HIGH PERFORMANCE**

**S276-02 + S284**

Sheartronic High Performance is an advanced system specifically designed to perform consolidation, direct and residual shear stages in a fully automated way. The system is based on a pneumatic closed-loop system which along with a high-performance regulator guarantees an automatic application of a vertical load up to 6000N, thus offering the unique possibility to reduce to the absolute minimum any form of manual intervention (no need of dead weights or level arms).

**TECHNICAL SPECIFICATIONS**

- Maximum horizontal force: 5000 N
- Maximum travel: 20 mm
- Shear speed: 0.00001 to 15.0000 mm/min
- Maximum vertical load: 6000 N (more than 600 kPa on a 100 x 100 mm square specimen) applied by a pneumatic piston controlled by a closed loop system with a 10 bar pressure transducer
- Max air pressure supply: 10 bar
- Max working air pressure: 8 bar

**SHEARTRONIC SYSTEM INCLUDES:**

- S276-11** Shear frame with digital touch-screen microprocessor, complete with pneumatic vertical loading device, shear box case with adaptors, transducers supports.
- S277-20** Load cell, electric, 3000 N capacity, complete with cable (5000N cell available on request).
- S336-11** Linear vertical transducer, 10 mm travel
- S336-12** Linear horizontal transducer, 25 mm travel
- S277-31** Firmware activating 3 connectors for basic data acquisition

Technical specifications of the frame and firmware: see p. 536

**Power supply:** 230V 1ph 50-60Hz 200W

**Dimensions:** 1030x400x580 mm

**Weight:** 100 kg approx.

## FIRMWARE

Similar to S276 KIT and S276-01 machines but with the new possibility to identify directly on the consolidation curve the effects of the primary consolidation. Sheartronic High Performance automatically calculates the appropriate shear velocity to be applied to the specimen by selecting the optimal consolidation parameter among  $t_{50}$ ,  $t_{90}$  and  $t_{100}$ , improving efficiency and cost effectiveness.

### Note:

1. shear box, hollow punch, tamper (see accessories) and Software S277-41N **are not included** and have to be ordered separately
2. The pneumatic shear machine mod. S276-02 requires an air compressed source.
3. The machine is configured to accommodate an additional piston to apply a max vertical load of 10000 N

## RECOMMENDED ACCESSORIES

**S262-11** AIR FILTER, auto-draining, it reduces up to one micron, complete with discharge

**S277-41N** SOFTWARE SHEAR LAB CONNECT

For fully automatic data control, acquisition, processing and visualization in direct/residual shear tests, with graphics on all the test phases (technical details: see p. 542)

## ACCESSORY

**V207** LABORATORY AIR COMPRESSOR, 50 litres capacity, 10 bar nominal pressure



V207

## GAUGE BLOCKS. Grade 1

Used to calibrate the linear displacement transducers.  
Available models:

**S336-41** Gauge block, nominal length 5 mm

**S336-43** Gauge block, nominal length 10 mm

**S336-45** Gauge block, nominal length 25 mm



S336-41

S336-43

S336-45

S336-47

## SPARES

**S335-15** Universal coupling pliers for dial gauge/transducer. It accepts all Matest displacement transducers and dial gauges (dia. from 8 to 20 mm)

**S280-15** Mounting device between the universal coupling pliers S335-15 and the shear machine to fix the vertical displacement transducer or dial gauge

**S280-16** Mounting device between the universal coupling pliers S335-15 and the shear machine to fix the horizontal displacement transducer or dial gauge



S280-16

S280-15

S335-15



## S277-41N

### SOFTWARE SHEARLAB CONNECT

STANDARDS: ASTM D3080 | NF P94-071-1, P94-071-2 | BS 1377:7

ShearLab Connect is an extension of the ShearLab Reports S277-40N software, specifically designed for automatic data control, acquisition, processing and visualization of direct/residual shear tests.

The file obtained can be then added to a project created with ShearLab Reports S277-40N, which features are detailed on p. 539

The program can be used in a very simple and intuitive way; a dedicated window allows to select the machine the user wants to work with while a test-specific setup guides the acquisition process, including data collection parameters that best fit the specific test. All test-specific initial, intermediate and final parameters are calculated based on input of specimen information, such as sample type (cylindric or square), sample diameter or width (mm), initial height of sample (mm), initial and final wet masses (g), dried mass after oven (g), applied load (kg), grain density ( $\text{kg/m}^3$ ), consolidation time (min).

ShearLab Connect can be connected to one or more shearing machines, thus allowing automatic data control and acquisition during the test. Each Sheartronic is connected via LAN or serial cable to the PC

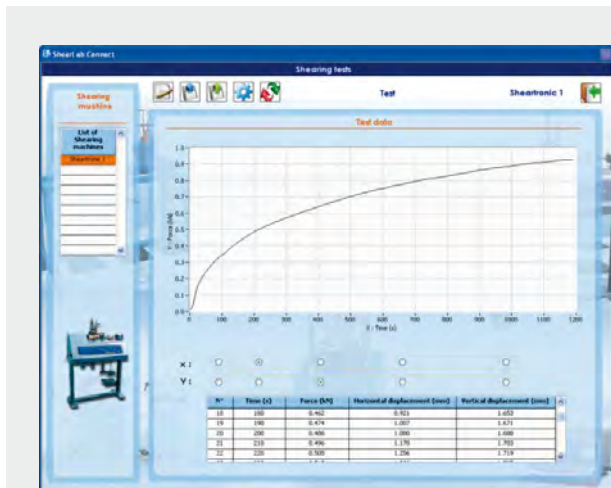

**S277-41N** Test-specific parameters

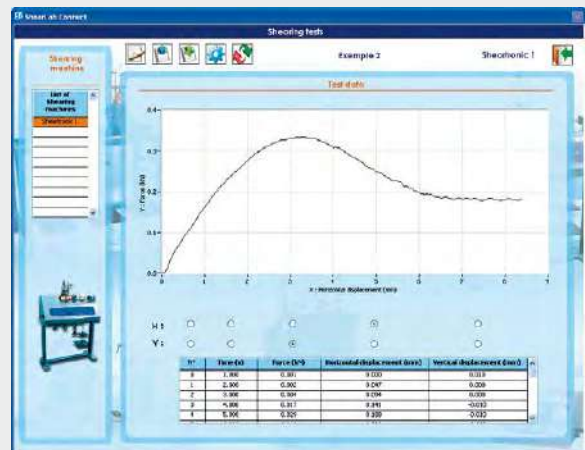

**S277-41N** Test-specific parameters

Displayed CHARTS (by selecting 2 of the following parameters):

- Time (s)
- Applied force (kN)
- Horizontal displacement (mm)
- Vertical displacement (mm)

PC specification:

- Operating system: Windows XP or more recent
- Supplied complete with LAN cable.

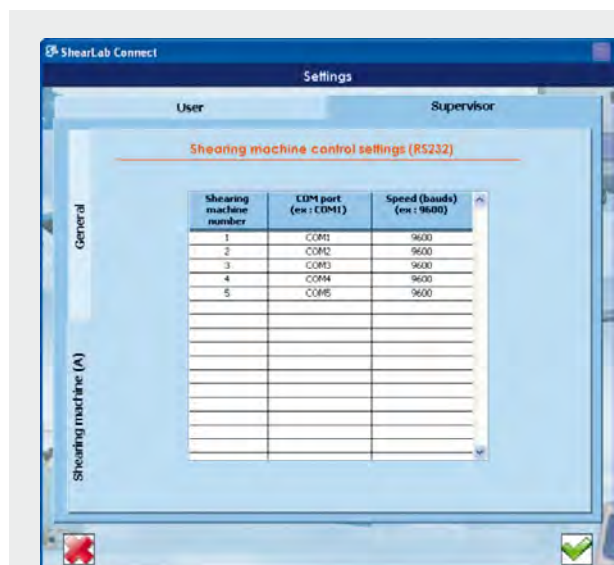

**277-41N** Control settings

## TRIAXIAL TESTS

STANDARDS: BS 1377:8 | ASTM D2850, ASTM D4767, ASTM D7181 | NF P94-070, NF P94-074 | CEN-ISO | TS 17892-8.9

### Introduction

A knowledge of stress-strain behaviour and the shear strength parameters of soils is required when soil is interacting with structures or when soil is used as a construction material in many engineering purposes such as:

1. Excavations
2. Shallow foundations
3. Piles and deep foundations
4. Earth retaining structures, diaphragm walls, anchors
5. Slope stability
6. Ground improvement
7. Design of embankments, earth dams

The most widely used testing apparatus for investigating the stress-strain behaviour and the strength parameters of soils is the triaxial apparatus.

Triaxial tests are typically performed with two stages: an isotropic loading followed by shear loading which is carried out up to failure. A cylindrical saturated soil sample, undisturbed or reconstituted, is placed in a rubber membrane in order to isolate it from direct contact with the surrounding water with which the testing cell is filled, and which is pressurized. The sample sits in the cell between a rigid base and a rigid top cap and is loaded by means of a ram, at a constant speed. The water drainage in or out the sample can be allowed by means of opening or closing a valve.

The two phases are carried out under different combinations of drainage conditions and give rise to 3 different standard triaxial tests. Each test is usually performed on three saturated specimens at three different confining pressures.

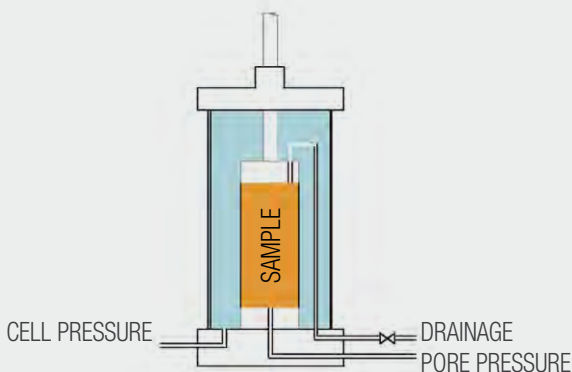

### “UU” unconsolidated undrained test

This test is used in order to estimate the undrained shear strength parameters (undrained shear strength  $c_u$  and undrained friction angle  $\phi_u = 0$ ). It is usually performed on fine grained soils. In this test, both phases are carried out with the drainage valve closed. No volume change is allowed during the test and distortions during the shear phase occur up to the failure. This test gives a unique value of undrained shear strength, as the envelope of the Mohr circles plotted in total stresses is horizontal. The angle  $\phi_u$  has to be zero or it is an error in the test, e.g. poor saturation.

The stress-strain behaviour and the strength parameters are then used to model engineering problems when undrained conditions are present, typically in short term design.

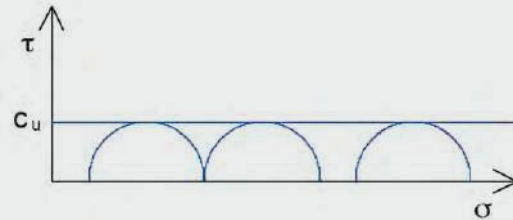

### “CU” consolidated undrained test

This test is used in order to estimate the drained and undrained shear strength parameters (effective cohesion  $c'$ , effective friction angle  $\phi'$ , and undrained shear strength  $c_u$ ). It is usually performed on fine grained soils. In this test, the first phase is carried out with an open drainage valve in order to allow the consolidation and volume change to occur. During the second phase, the drainage valve is closed and the change of pore water pressure is measured; there is no volume change and distortions occur up to failure. It gives three values of undrained shear strength, which are the radii of the Mohr's circles, and the values of the effective cohesion and of the effective friction angle, which are derived from the envelope of the effective stress Mohr's circles. The stress-strain behaviour and the strength parameters are then used to model engineering problems when undrained conditions are present, after consolidation processes or in long term applications.

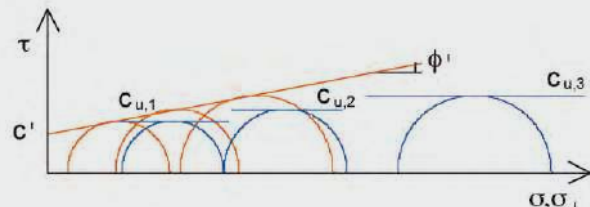

### “CD” consolidated drained test

This test is used in order to estimate the effective shear strength parameters (effective cohesion  $c'$ , effective friction angle  $\phi'$ ). It is usually performed on coarse grained soils. In this test, both phases are carried out with the drainage valve open. Volume change occurs in both phases and during the second phase, distortions occur up to failure. The CD test gives the values of the effective cohesion and of the effective friction angle, which are derived from the envelope of effective stress Mohr's circles. The stress-strain behaviour and the strength parameters are then used to model engineering problems when drained conditions are present, typically in long term design.

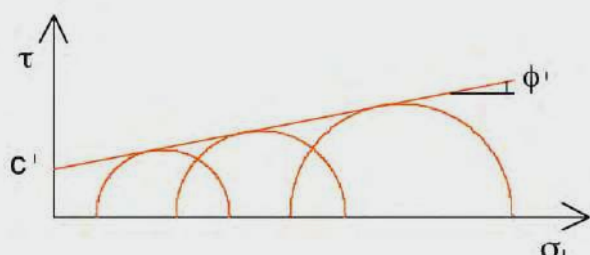

## S301N TRIAXIAL LOAD FRAME 50KN, DIGITAL TOUCH-SCREEN



This versatile, compact, heavy duty load frame has been designed for routine tests, for central laboratories, but also for research purposes.

The frame is of rigid chromed steel twin column construction.

The electronic color digital touch-screen display with microprocessor control system allows to perform tests within a speed range of 0.00001 to 12 mm/min.

The maximum load capacity is 50 kN, and it is suitable either for cells S305 (max. specimen size 70x140mm) and S306 (max. specimen size 100x200mm),

Matest or other manufacturers made. The system guarantees high resolutions in real time. The load plate is foreseen of electric end of stroke, to save the machine from wrong manipulations.

### Frame Specifications:

- Maximum load capacity: 50kN
- Infinitesimal testing speed: from 0.00001 to 12 mm/min.
- Minimum vertical clearance: 400 mm (140 mm with ring)
- Maximum vertical clearance: 1100 mm (840 mm with ring)
- Horizontal clearance: 380 mm
- Platen diameter: 177 mm

### Firmware:

- Electronic control unit "Cyber-plus Evolution" with Touch-Screen color graphic display ¼ VGA, that runs like a standard PC based on Windows operating system for the management of the data. (Analysis of the data, test results, graphs with S335-10N software; optional accessory).
- The Touch-Screen icon interface allows an easy set-up of the parameters and immediate execution of the test.
- The machine can perform the tests without any external PC, because of the "Cyber-Plus" grants performances like a PC.
- Direct connection to Intranet (connection to a LAN network) and Internet to establish a remote communication and receive an immediate diagnosis from Matest technicians, or for upgrades of the Firmware.
- Unlimited memory storage with: 2 USB ports, 1 SD card.
- Possibility to select different languages.
- Hardware technical details: see p. 18
- The machine is equipped with 8 connectors for the acquisition and data processing system up to 8 analogical/digital channels (that is activated with the S301-05 optional firmware) for load cells and transducers. Extra slot available to expand the on-board channels to 16 (with S301-06)



**S301N with data acquisition**



**S301N with load ring**

The frame is supplied with loading ram and sphere, but **without** load rings, dial gauges, electric load cells or displacement transducers that **have to be ordered separately** (see next pages).

**Power supply:** 230V 1ph 50-60Hz 600W

**Dimensions:** 490x510x1800 mm

**Weight:** 115 kg approx.

 **Note:** Triaxial load frame 50kN is available also with wider variable speed range from 0.00001 to 100 mm/min. See model S301-02



**Detail of the 8 connectors**

### UPGRADING ACCESSORIES

**S301-05** FIRMWARE FOR ACQUISITION AND DATA PROCESSING system up to 8 analogical/digital channels for load cells and transducers. Graphic and numbers visualization, processing, printing and storing of the test results. This software activates the 8 connectors foreseen on the load frame.

**S301-06** 8-CHANNEL INTERNAL MODULE, for system expansion to 16 channels of the triaxial load frame. This upgrade is possible only in Matest factory.

**S335-10N** SOFTWARE TRIAXLAB CONNECT & REPORTS See p. 554

## S301-02

**AVANT-GARDE**  
**TRIAXIAL LOAD FRAME 50 kN**

EXPANDED VARIABLE SPEED RANGE



Matest Avant-garde is the new high-performance load frame specifically designed for advanced laboratories.

The expected variable speed range of this electro-mechanical machine **up to 100 mm/min** makes it suitable to perform Unconfined, CBR and Marshall tests other than standard triaxial tests.

This heavy-duty load frame has provision for automatic load and displacement/deformation control, thanks to the latest generation control board incorporated into the machine. Distinguished by its **elegant shape with rounded corners**, Avant-garde counts with a **touch-orientable display**, front mounted, which allows an easy and innovative control of the main functions and data acquisition, including detailed charts.

If desired, the display can be detached by using a dedicated Kit to allow on-spot complete test managing. This feature might be useful in cases where a direct overview of hardware is preferred (eg pre-saturation conditions checks during triaxial testing).

**MAIN FEATURES**

- Maximum testing speed: 100 mm/min
- Maximum specimen diameter: 150 mm
- Maximum compression capacity: 50kN
- Suitable to perform Unconfined, CBR, Marshall and Standard Triaxial tests.
- 10 profiles, with a potential of 80 storable calibrations, for an immediate use of multiple sensors.
- Real time display of time, load, deformation, displacement and graph simultaneously.
- Responsive and precise control board.

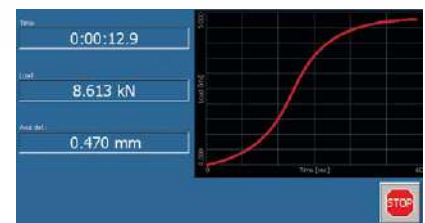
**S301-02**

Load vs time graph during triaxial testing

**THECNICAL SPECIFICATIONS****HARDWARE**

- Maximum Sample Diameter : 150 mm
- Minimum testing speed : 0.00001 mm/min
- Maximum testing speed : 100 mm/min
- Maximum compression force: 50 kN
- Minimum vertical clearance : 390 mm
- Maximum vertical clearance : 1100 mm
- Horizontal clearance : 380 mm
- Platen diameter : 177 mm
- Platen travel : 100 mm

**Dimensions:** (h x w x d) 1675x500x530 mm approx.

**Power supply:** 230V 1ph 50/60Hz 1500W

**Weight:** 130 kg approx.

**FIRMWARE**

- Display LCD, TFT, 800x480 pixels, 7 inches, graphic touchscreen
- 8 analog channels (24 bit) suitable for connection of load, displacement, deformation, LVDT, temperature (PT100, PT1000, NTC) transducers and strain gauges (by using an external adapter).
- Ethernet, RS232, RS485, 2 x USB Host-port.
- Slot for Micro SD



Triaxial test general settings

## TRIAXIAL CELLS

Triaxial cells are provided in two different dimensions, mod. S305 and S306. Top and low cell caps are made in aluminium corodal alloy and the transparent cell cylinder is in high resistant acrylic material. The cell can be easily assembled and disassembled by means of quick clamping rods. In order to reduce as much as possible friction, a particular care is deserved during loading ram realisation. The low cell cap is supplied with "four inlet valves": back pressure, low drainage, pore pressure, cell pressure.

In order to measure the specimen axial deformation, an adjustable dial gauge or a displacement transducer is also provided.

**Note:** No top caps, base adapters, rubber membranes and sealing rings, porous stones, dial gauges, etc. are included and **should be ordered separately**. In the table all accessories for triaxial cells are listed.

**S305 WITH ACCESSORIES**
**S306**

Models	S305	S306
Max. specimen size mm	Ø 70x140	Ø 100x200
Max. cell pressure	1700 kPa	1700 kPa
Overall dimensions mm	Ø 280x480	Ø 310x540
Weight kg	8	16

**Note:** Cell S305 can be also used also for specimens having diameter 50x100 and 38x76 mm with accessories of suitable diameter, but it is not suitable for 100x200 mm samples.

**Note:** Cell S306 can be also used also for specimens having diameter 70x140, 50x100 and 38x76 mm with accessories of suitable diameter.

### MAXIMUM REACHABLE VERTICAL TOTAL STRESS:

Sample	Ø 38x76 mm	Ø 50x100 mm	Ø 70x140 mm	Ø 100x200 mm
Cell <b>S305</b>	~ 44 MPa	~ 25 MPa	~ 13 MPa	–
Cell <b>S306</b>	~ 44 MPa	~ 25 MPa	~ 13 MPa	~ 6 MPa

Accessories for Triaxial Cells:	Ø 38x76 mm	Ø 50x100 mm	Ø 70x140 mm	Ø 100x200 mm	Ø 150x300 mm
Rubber membrane (pack of 10)	S310	S310-01	S310-02	S310-03	S310-04
"O" ring (pack of 10)	S311	S311-01	S311-02	S311-03	S311-04
Membrane stretcher	S312	S312-01	S312-02	S312-03	S312-05
Split former	S313	S313-01	S313-02	S313-03	S313-04
Split mould <b>NEW</b>	S313-10	S313-11	S313-12	S313-13	S313-14
Top cap with drainage	S314	S314-01	S314-02	S314-03	S314-04
Base adapter for cell. mod. S305	S315	S315-01	S315-02	–	–
Base adapter for cell. mod. S306	S315-04	S315-05	S315-06	S315-07	–
Porous disc (2 pcs)	S316	S316-01	S316-02	S316-03	S316-04
Perspex plain disc (2 pcs)	S317	S317-01	S317-02	S317-03	S317-04
"O" ring for base adapter	S318	S318-01	S318-02	S318-03	S318-04
Filter paper for lateral drainage (50 pcs)	S319	S319-01	S319-02	S319-03	S319-04
Filter paper for base (100 pcs)	S320	S320-01	S320-02	S320-03	S320-04
Stainless core cutter	S122-13	S122-14	S122-15	S122-16	
Dolly for extraction	S123-13	S123-14	S123-15	S123-16	
Drainage burette, 10 ml cap.	S321	S321	S321	–	
Drainage burette, 50 ml cap.	–	–	–	S322	
Nylon tube Ø 6x4 (20 m)	S325	S325	S325	S325	
Terminal for connection tube (10 pcs)	S326	S326	S326	S326	
Flaring tool	S327	S327	S327	S327	
Vaseline oil (1000 ml)	S328	S328	S328	S328	
Silicon grease (1 kg)	S329	S329	S329	S329	
Grease pump	S330	S330	S330	S330	
Null displacement valve (spare)	S331	S331	S331	S331	

**Note:** Mod. S307 triaxial cell max. 150x300 mm for cyclic tests is described at p. 569

## ACCESSORIES

RUBBER MEMBRANE, to isolate the specimen from cell water.

“O” RING, to seal the membrane around the top cap and the base adapter.

MEMBRANE STRETCHER, to stretch the membrane during its positioning, avoiding to disturb the specimen.

SPLIT FORMER, to prepare coarse grain soil specimens. It is made of two aluminium halves.

SPLIT MOULD, to trim the ends of undisturbed specimens. It is made of two aluminium halves. **NEW**

TOP CAP WITH DRAINAGE, to load the whole cross section area of specimen when drainage is required. It is made of anodized aluminium. Connector is provided.

BASE ADAPTER, used to adapt the triaxial cell to the specimen diameter. It is made of aluminium.

POROUS DISCS, to allow the drainage in or out of the specimen in the whole cross sectional area, toward the top cap and the lower base. Two pieces are required. They are made of phosphor bronze.

PERSPEX PLAIN DISCS, to replace porous discs in undrained tests. Two pieces are required. They are made of 10 mm thick Perspex.

FILTER PAPER FOR LATERAL DRAINAGE, for lateral drainage on low permeability specimens.

FILTER PAPER FOR BASE, to avoid passages of soil particles into the porous stones.

CORE CUTTER, to cut soil cohesive specimens in correct diameters from bigger samples. It is made of stainless steel with a cutting edge.

**NEW**

S313-10

S313-11

S313-12

S313-13



DOLLY FOR EXTRACTION, to extrude the specimen from the core cutter.

DRAIN BURETTE, to prepare coarse grain specimens by applying a negative pressure to the base of the specimen and to measure the water volume change in or out the specimen during testing with specimen open to the atmosphere. Two models are available: 10 ml capacity for specimens up to 70 mm  $\phi$  and 50 ml for specimens up to 100 mm  $\phi$ . It is supplied with cell rod and cell couplings.

“O” RING FOR BASE ADAPTER, to seal the membrane on the base adapter and the top cap.

FLARING TOOL, to cut and prepare the ends of nylon tubes which have to be fixed to the suitable connectors.



S321...S331



## MEASURE OF THE AXIAL FORCE APPLIED TO THE SPECIMEN

Three different equipments are available to measure the axial force applied to the specimen:

- load proving rings (manual readings)
- load cells (automatic readings)
- submersible load cells (automatic readings and no friction effects)

### LOAD PROVING RINGS

Mechanical equipment for manual reading. In order to avoid any overload damage, an electrical safety device is supplied to stop the loading process when the maximum capacity of the ring is reached. Technical details, other models and accessories see p. 573

Max Capacity load kN	Dial Gauge 0.01 mm	Dial Gauge 0.001 mm	Height mm	Weight kg
1	<b>S370-01S</b>	<b>S371-01S</b>	210	1.7
3	<b>S370-03S</b>	<b>S371-03S</b>	210	1.9
5	<b>S370-04S</b>	<b>S371-04S</b>	210	2
10	<b>S370-05S</b>	<b>S371-05S</b>	210	2.2
20	<b>S370-07S</b>	<b>S371-07S</b>	210	3
50	<b>S370-10S</b>	<b>S371-10S</b>	210	7.2

### ACCESSORY

#### S374 STEM MECHANICAL BRAKE DEVICE

It keeps the max. reached value on the dial gauge and allows the manual zero setting.

### ELECTRIC STRAIN GAUGE LOAD CELLS

Electrical equipment for automatic reading. The load cell must be connected to the automatic data acquisition system mod. S334 (see p. 559). Cable, connector and device to fix the load cell to the triaxial frame are supplied.

Rated output: 2 mV/V nominal  
Accuracy: 0.1%

Models	Capacity
<b>S337-31</b>	2.5 kN
<b>S337-35</b>	5 kN
<b>S337-32</b>	10 kN
<b>S337-33</b>	25 kN
<b>S337-34</b>	50 kN



**S337-34**



**S337-32**



**S370-03S**

**S371-07S**

### SUBMERSIBLE LOAD CELLS

Submersible electrical equipment for automatic reading.

The submersible load cell must be placed inside the cell and connected to the automatic data acquisition system mod. S334 (see p. 559).

It is made of high quality materials. It is a sealed waterproof device with an excellent resistance to lateral forces.

It guarantees no friction effect of the ram. It is strongly recommended when high accuracy in testing is required.

It must be equipped with the loading ram mod. S337-21.

Rated output: 2 mV/V nominal

Accuracy: 0.1%

Non-linearity: 0.05%

Models	Capacity
<b>S337-02</b>	3 kN
<b>S337-03</b>	5 kN
<b>S337-04</b>	10 kN
<b>S337-05</b>	25 kN

### ACCESSORIES

**S337-21** LOADING RAM: Loading ram for submersible cells

**S337-51** CALIBRATION PROCESS of one device that is combined with the acquisition/processing system mod. S334.

To be chosen among:

- displacement transducer mod. S336-11 to S336-22,
- electric load cell mod. S337-02 to S337-34.

Calibration certificate is supplied.



## MEASURE OF THE AXIAL STRAIN

Two different equipments are available to measure the specimen axial displacement:

- Dial gauges (manual readings)
- or:
- Displacement transducers (automatic readings)



### DIAL GAUGES (manual readings)

- S377** Dial gauge, 25x0.01 mm suitable for specimens of max. dimensions 50x100 mm
- S379** Dial gauge, 50x0.01 mm suitable for specimens of max. dimensions 70x140 mm
- S383** Dial gauge, 25.4x0.001 mm with RS 232 port for PC connection.

**Note:** For other requirements, dial and digital gauges with different maximum travel and sensibility are also available: see technical details at p. 574.



**Note:** The displacement transducers must be connected to the automatic data acquisition system mod. S334 (see p. 559) or mod. S301-05 (see p. 544).

### ACCESSORIES for DISPLACEMENT TRANSDUCERS

- S336-30** Extension cable 2 metres long
- S336-31** Extension cable 5 metres long
- S336-32** Extension cable 10 metres long

**Note:** It is recommended to use not more than 10 m of extension cable to avoid noise problems that might occur.

- S335-15** Universal coupling pliers to hold the transducer/dial gauge. It fits all Matest displacement transducers and dial gauges (from  $\varnothing$  8 mm to 20 mm).
- S305-05** Mounting device of the universal coupling pliers mod. S335-15 to fix the displacement transducer/dial gauge to the Triaxial Cell mod. S305 or mod. S306

### DISPLACEMENT TRANSDUCERS (automatic readings)

Electrical devices for automatic readings. Calibration certificate is supplied. Cable, connector and signal conditioner are provided.

TYPES OF AVAILABLE TRANSDUCERS:

**TYPE "A":** Accurate and versatile linear potentiometric displacement transducer.

Independent linearity < 0.3% (0.3x10 mm)  
Max. displacement speed: up to 10 m/s.

#### MODELS

- S336-11** 10 mm travel
- S336-12** 25 mm travel
- S336-14** 50 mm travel
- S336-13** 100 mm travel

**TYPE "B":** Linear Strain Gauge Transducer. It guarantees good repeatability and noise reduction.

Full bridge at 350 Ohm  
Independent linearity < 0.1%  
Standard sensitivity: 2 mV/V

#### MODELS

- S336-18** 5 mm travel
- S336-15** 10 mm travel
- S336-16** 25 mm travel
- S336-17** 50 mm travel

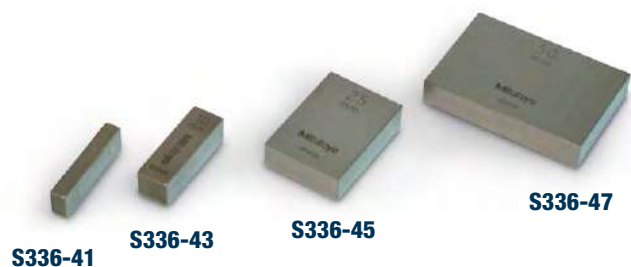

### GAUGE BLOCKS. Grade 1

Used to calibrate the linear displacement transducers.

#### MODELS

- S336-41** Nominal length 5 mm
- S336-43** Nominal length 10 mm
- S336-45** Nominal length 25 mm
- S336-47** Nominal length 50 mm



## PRESSURE SYSTEMS

Two different solutions are available:

- Oil/Water motorized constant pressure system
- Air/Water interface system with air pressure regulator (to be connected to a pneumatic compressor)

### A144 OIL/WATER CONSTANT PRESSURE SYSTEM

This unit provides a constant pressure from 0 to 3500 kPa by using a motorized hydraulic pump, an oil/water interchange tank, ram/spring, valves and connectors, high viscosity oil. Test pressure precision gauge, range 0-3500 kPa is supplied. To be noted that the maximum tolerable pressure in the cell is 1700 kPa.

**Power supply:** 230V 1ph 50Hz  
**Dimensions:** 320x320x410 mm  
**Weight:** 20 kg approx.



A144

### S350N AIR/WATER BLADDER PRESSURE SYSTEM

It provides a water pressure up to 1700 kPa. Simple, practical and extremely accurate system used to select test pressures, it can also offer the possibility to further system expansions. The use of deaerated water is recommended. It must be connected to a pneumatic compressor as mod. S351N or mod. V207. The cell set is equipped with an inlet high pressure air valve and 2 outlet valves for pressurized water and water.

**Dimensions:** 270x300x425 mm  
**Weight:** 9 kg approx.

#### ACCESSORIES

**S350-05N** PRESSURE REGULATOR, high accuracy model, to preset and control the work pressure, complete with two outlet air valves.

**S355-01** FILTER UNIT (water trap) composed by filtering device and interchangeable cartridge, used to collect moisture.

#### SPARE

**S350-04** Membrane for air/water cell.  
 Pack of 2 pieces.



S355-01

S350-05N

S350-04

S350N

### S351N LABORATORY AIR COMPRESSOR

It reaches a maximum pressure of 15 bar and it must be used with the air/water interface cell.

Sucked air: 84 litre/minute.  
 Reservoir capacity: 3 litres.

**Power supply:**  
 230V 1ph 50Hz 0.75HP  
**Dimensions:**  
 460x300x470 mm  
**Weight:** 22 kg approx.



S351N

### S350-08N PRESSURE MULTIPLIER **NEW**

Made in anodized aluminum, this device doubles the hydraulic pressure output from the air/water pressure system (S350N) and it enables confined triaxial tests to be performed up to 20 bar whenever an air compressor capable of maintaining a pressure of 10 bar is used. The amplification factor is guaranteed by special testing and calibration performed in our facilities: output pressure (manometer of the pressure source) is multiplied by this factor. An autonomous digital manometer 0 – 20 bar is available as an option for direct readout of pressure. A bypass valve shuts off the amplification, so there is no need to remove the device from the line when not needed.

**Maximum displacement:** 400 cm<sup>3</sup>  
**Dimensions:** Ø150 x 350 (h) mm  
**Weight:** 8 kg approx.



S350-08N

#### ACCESSORY

**S342-06** Digital manometer scale 0-2000 kPa with battery supply.

### S355 DE-AIRING TANK 20 LITRES CAPACITY

It produces de-aired water when connected to the vacuum pump. It is a perspex tank with an inlet water valve and an outlet air valve. Tank capacity: 20 litres.

**Dimensions:** 320x320x520 mm  
**Weight:** 15 kg approx.



S355

#### ACCESSORIES

**V205** VACUUM PUMP

**V205-10 - V205-12** VACUUM REGULATOR

**V230-03** Rubber tube. Suitable for vacuum, 3 m

#### Note:

Other models of vacuum pumps described at p. 597

## PRESSURE SYSTEM

### S340 DIAL GAUGE UNITS 4 VALVES TO MEASURE PRESSURE (0-1700 KPa)

4 inlet/outlet null displacement valves are supplied with the dial gauge. Used to measure water pressure as cell pressure or pore pressures. The dial gauge is set in a metallic support. Pressure range: 0-1700 kPa.

**Dimensions:** 410x350x110 mm

**Weight:** 6 kg approx.



S340

### S345 SCREW PUMP

It has to be connected to the pressure dial gauge unit and it is used to control water pressures by means of small screw rotations. It can decrease or increase pressures as required.

**Weight:** 3 kg approx.



S345

S348

S350-01

### S348 DISTRIBUTION UNIT

It is provided with 5 inlet/outlet valves with null variation of volume. All valves are connected to an aluminium support. It is used to deliver pressurized water to different lines.

**Dimensions:** 200x200x55 mm

**Weight:** 3 kg approx.

**S350-01** Two-way distribution valve for air or water.

### S342-01 2 WAYS PRESSURE PANEL



This pressure panel is designed to distribute the water pressure used in soil laboratory applications, such as automatic triaxial systems. The panel is constituted by two pressure lines fitted with high accurate regulators and pressure valves.

**Dimensions:** 416x430x181 mm

**Weight:** 10 Kg approx.



S342-01

S342-06

### S342-02 3 WAYS PRESSURE PANEL



Identical to the S342-01 but fitted with three pressure lines.

**Dimensions:** 460x430x181 mm

**Weight:** 13 Kg approx.



S342-02

S342-06

## ACCESSORY

**S342-06** DIGITAL GAUGE to be fitted on S342-01 and S342-02.  
Resolution: 1 kPa

## SPARES

**S342-04** Pressure air regulator, 10 bar

**S325** Nylon tube  $\varnothing$  4x6 mm

## PORE PRESSURE TRANSDUCER

It is a good reliability electronic device used to measure pore pressure. It requires a de-airing block. Every transducer must be connected to the automatic data acquisition system mod. S334 (see p. 559) or mod. S301-05 (see p. 544).

- Input voltage: 10 volts dc, Sensitivity range: 2 - 4 mV/V
- Accuracy: 0.15 fs
- Pressure connection: 0.25 BSP
- Protected against corrosive pore water pressure
- 2 metres cable and 5 pin plug included

### MODELS

**S336-50** Pressure transducer up to 1000 kPa

**S336-51** Pressure transducer up to 2000 kPa

### ACCESSORIES

**S336-55** De-airing block for pressure transducer



## EXTENSION CABLE FOR TRANSDUCERS

### MODELS

**S336-30** 2 metres long

**S336-31** 5 metres long

**S336-32** 10 metres long

**Note:** It is recommended to use not more than 10m of extension cable to avoid noise problems that might occur.

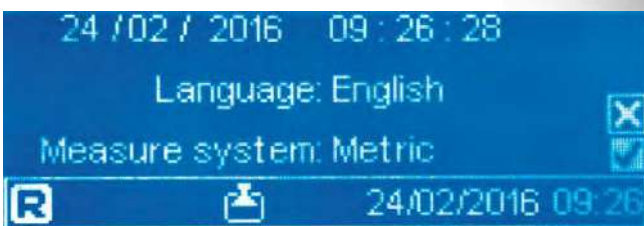

Channel configuration and calibration

## S356N

### 2 CHANNELS UNIT FOR PORE PRESSURE MEASUREMENT



Based on a high resolution graphic display this instrument allows continuous control and monitoring of pore pressure measurements coming from pressure transducers.

Models like S336-50 or S336-51 supplied along with proper connection cable can be plugged into this new S356N readout so that manual triaxial tests can be performed without need of automatic data acquisition units or outdated mercury manometers.

S356N unit allows real time visualization of the pore pressure measurements and subsequent peak data recording through its dedicated peak function.

### Technical specifications

- Measuring units (selectable): mbar, bar, MPa, kPa, psi
- Acquisition and data processing system at 24 bit, effective resolution: 17 bit.
- Operator interface composed by 5 multi-functions pushbuttons; function icons shown on the display
- The two analogue-digital channels accept sensors at 2mV/V
- Languages: see C108N at page 219...221
- Graphic display with high resolution: 192x64 pixels
- Class: 0.5% starting from 10% of maximum value

**Power supply:** 230V 1ph 50-60Hz

**Dimensions:** 230x145x240 mm

**Weight:** 4 kg approx

### ACCESSORIES for S356N

- Pressure transducers, available models see p. 549
- De-airing block
- Extension cables for transducers



S356N+S336-50+S336-51

## MEASURE OF VOLUME CHANGE

In order to measure volume changes during test, two solutions are proposed:

- **Double burette apparatus**
- **Standard or automatic volume gauge with displacement transducer or dial gauge.**

### S358 DOUBLE BURETTE VOLUME CHANGE APPARATUS

It is composed by two measuring burettes which are placed inside a perspex tube and connected directly to a reverse valve system.

A by-pass valve is also included.

Capacity: 200ml

Accuracy: 0.2ml

**Dimensions:** 230x270x860 mm

**Weight:** 5 kg approx.

### S338N VOLUME GAUGE

The unit consists of a metallic air/water interface. It measures the water volume changes inside the sample. It has to be used with linear strain transducer, or dial gauge.

Capacity: 100 ml

Accuracy: better than 0.1 ml.

**Dimensions:** 180x180x240 mm

**Weight:** 4.7 kg approx.

Easy de-airing of bottom and top chambers.  
No measuring device and mounting block are included (see accessories).

### S338-01 KIT AUTOMATIC VOLUME GAUGE

The unit consists of a 100 ml metallic air/water interface. A change valve box provides unlimited capacity.

Easy de-airing of top and bottom chambers. Displacement transducer, coupling pliers and mounting device are not included (see accessories)

Capacity : unlimited

Accuracy: better than 0.1 ml

**Dimensions:**

360x270x210 mm

**Weight:**

7.6 kg approx.

#### Note:

The volume gauge has to be used with linear strain transducer which must be connected to the automatic data acquisition system mod. S334 (see p. 559) or mod. S301-05 (see p. 544).



S358



S338N



S338-01 KIT

## ACCESSORIES for VOLUME GAUGES

**S336-12** Displacement transducer 25 mm travel TYPE "A"

**S336-16** Displacement transducer 25 mm travel TYPE "B"

 **Note:** Technical data for all transducers: see p. 549

**S335-15** Universal coupling pliers to hold the transducer/dial gauge. It fits all Matest displacement transducers and dial gauges (from Ø 8 mm to 20 mm).

**S338-05** Mounting device of the universal coupling pliers mod. S335-15 to fix the displacement transducer/dial gauge to the volume gauge.

### S359 THREE-CELLS CONSOLIDATION FRAME

It is used to apply a constant axial load to three specimens, at the same time. It performs an anisotropic consolidation stage reducing the consolidation testing times.

It is made of a resistant metallic structure which accepts up to 3 triaxial cells for specimens dia. 38 mm up to 100 mm, and it is provided with centering plate cells.

Load can be applied through an hanger with two different ratios:

- Ratio 1:1 (directly), maximum load for each cell: 50 kg
- Ratio 5:1 (by means of a lever), maximum load for each cell: 250 kg

**Dimensions:** 2300x400x1800 mm

**Weight:** 150 kg approx.

## ACCESSORIES

**S273 KIT** Set of slotted weights 50 kg

**S377** Dial gauge, 25x0.01 mm suitable for specimens of max. dimensions 50x100 mm

**S379** Dial gauge, 50x0.01 mm suitable for specimens of max. dimensions 70x140 mm

As an alternative:

**S336-12** Displacement transducer 25 mm travel

**S336-14** Displacement transducer 50 mm travel



S359 with accessories

## S335-10N SOFTWARE TRIAXLAB CONNECT & REPORTS

STANDARDS: NF P94-070, P94-074 | ASTM D2850-03a, D4767-95, D7181-11 | BS 1377:8

TriaxLab Connect is the new acquisition software for Matest triaxial systems. This software allows the user to:

- Configure the acquisition parameters necessary to conduct the test
- Perform all of the 3 steps of a triaxial test (saturation, consolidation and shearing)
- Calculate the t100 value used for the shearing speed
- Record data for each calculation step
- Save test data and test parameters

Hence, the files created by this software can be used in TriaxLab Reports to generate a report by selecting the dedicated Standards.

Both Connect and Reports programs can be used in a very simple and intuitive way. Thanks to a suitable window, TriaxLab Reports gives the opportunity to perform calculations for all triaxial tests (UU, CU+u or CD).



**S335-10N** Consolidation step in TriaxLab Connect

The software provides the user with a simple and flexible graphical interface, giving the possibility to view, edit and print all the parameters involved in triaxial tests.

### Laboratory coefficients of:

- Saturation
- Consolidation
- Shearing

### CHARTS:

- Water Volume (cm<sup>3</sup>) / Square-root Time (min)
- Press Load (kN) / Press Displacement (mm)
- Deviator Stress (kPa) / Axial Strain (%)
- Pore Pressure (kPa) / Axial Strain (%)
- Shear Stress (kPa) / Normal Stress (kPa)
- Volume Deformation (%) / Axial Strain (%)
- Stress t' (kPa) / Stress s' (kPa)
- Effective Principal Stress Ratio / Axial Strain (%)

### PC specification:

- Operating system: Windows XP or more recent

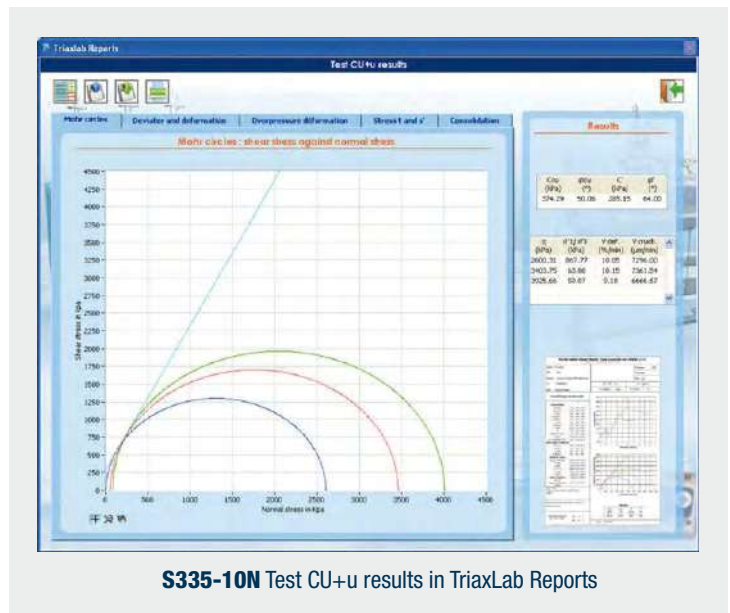

**S335-10N** Test CU+u results in TriaxLab Reports

RECOMMENDED TYPICAL CONFIGURATION OF THE TRIAXIAL SYSTEM WITH ONE CELL  
IN ANALOGUE, DIGITAL AND DIGITAL WITH SUBMERSIBLE LOAD CELL VERSIONS

APPARATUS SECTION	ITEM CODE	ITEM DESCRIPTION	ALTERNATIVE ITEM	ANALOGUE CELL SET	DIGITAL CELL SET	DIGITAL CELL SET with Submersible Load Cell
Hardware	<b>S301N</b>	digital triaxial load frame 50 kN		1	1	1
	Software	<b>S301-05</b> <b>S305</b> <b>S335-10N</b>	acquisition and data processing triaxial cell dia max. 70 x 140 mm software triaxlab reports - Matest Made	S306	- 1 -	1 1 1(opt)
Measure of Axial force	<b>S370-05S</b>	load proving ring 10 kN	S370/1-xxS	1	-	-
	<b>S374</b>	stem mechanical brake device		1(opt)	-	-
	<b>S337-32</b>	electric load cell 10 kN capacity	S377-31..34	-	1	-
	<b>S337-04</b>	submersible load cell 10 kN	S337-02..05	-	-	1
	<b>S337-21</b>	loading ram for submersible cell		-	-	1
	<b>S337-51</b>	calibration process for load cell		-	1(opt)	1(opt)
Measure of Axial strain	<b>S377</b>	dial gauge 25 mm	S379	1	-	-
	<b>S336-12</b>	displacement transducer 25 mm	S336-16	-	1	1
	<b>S336-31</b>	extension cable 5 m	S336-30..32	-	1	1
	<b>S335-15</b>	universal coupling pliers		1	1	1
	<b>S305-05</b>	mounting device for pliers		1	1	1
	<b>S337-51</b>	calibration process for displacement transducer		-	1(opt)	1(opt)
	<b>S336-45</b>	gauge block 25 mm	S336-41..47	-	1(opt)	1(opt)
De-aired water system	<b>S355</b>	de-airing tank		1	1	1
	<b>V205</b>	vacuum pump		1	1	1
	<b>V205-10</b>	vacuum regulator		1	1	1
	<b>V205-12</b>	moisture filter		1	1	1
	<b>V230-03</b>	rubber tube 3 m		1	1	1
Pore pressure system and measure	<b>S350N</b>	air/water interface pressure system	A144	2	2	2
	<b>S351N</b>	laboratory air compressor 17 bar (only if S350N system is chosen)	V207	1	1	1
	<b>S350-04</b>	membrane for air/water cell (spare) (only if S350N system is chosen)		1(opt)	1(opt)	1(opt)
	<b>S350-05N</b>	pressure regulator (only if S350N system is chosen)		2	2	2
	<b>S355-01</b>	filter unit		1	1	1
	<b>S340</b>	dial gauge unit 4 valves (only if S350N system is chosen)	S342-01 + S342-06	2	2	2
	<b>S345</b>	screw pump (only if S340 is chosen)		2	2	2
	<b>S348</b>	distribution unit		-	-	-
	<b>S350-01</b>	2-way distribution valve		5	5	5
	<b>S336-51</b>	pore pressure transducer 2000 kPa (cell pressure + pore + back pressure)	S336-50	-	3	3
	<b>S336-55</b>	de-airing block		-	3	3
	<b>S336-31</b>	extension cable 5 m	S336-30..32	-	3	3
	<b>S356N</b>	digital pore pressure readout		1(opt)	-	-

Measure of Volume change	<b>S358</b>	double burette system	S338N	1	-	-
	<b>S377</b>	dial gauge 25 mm (only if S338N system is chosen)		1	-	-
	<b>S335-15</b>	universal coupling pliers (only if S338N system is chosen)		1	-	-
	<b>S338-05</b>	mounting device for pliers (only if S338N system is chosen)		1	-	-
	<b>S338-01 KIT</b>	automatic volume gauge	S338N	-	1	1
	<b>S336-12</b>	displacement transducer 25 mm	S336-16	-	1	1
	<b>S336-31</b>	extension cable 5 m	S336-30..32	-	1	1
	<b>S335-15</b>	universal coupling pliers		-	1	1
	<b>S338-05</b>	mounting device for pliers		-	1	1
	<b>S337-51</b>	calibration process for displacement transducer		-	1(opt)	1(opt)
Specimen preparation and Accessories	<b>S310</b>	rubber membrane (10 pcs) (accordingly to specimen dimensions)	S310-01..03	1+	1+	1+
	<b>S311</b>	"O" ring (10 pcs) (accordingly to specimen dimensions)	S311-01..03	1+	1+	1+
	<b>S312</b>	membrane stretcher (accordingly to specimen dimensions)	S312-01..03	1	1	1
	<b>S313</b>	split former (accordingly to specimen dimensions)	S313-01..03	1	1	1
	<b>S313-10</b>	split mould (accordingly to specimen dimensions)	S313-11..13	1	1	1
	<b>S314</b>	top cap with drainage (accordingly to specimen dimensions)	S314-01..03	1	1	1
	<b>S315</b>	base adapter for cell (accordingly to cell model and specimen dimensions)	S315-01..07	1	1	1
	<b>S316</b>	porous disc (2 pcs) for CD/CU/UU tests (accordingly to specimen dimensions)	S316-01..03	1	1	1
	<b>S317</b>	plain disc (2 pcs) for UU test only (accordingly to specimen dimensions)	S317-01..03	1	1	1
	<b>S318</b>	"O" ring for base adapter (accordingly to specimen dimensions)	S318-01..03	1+	1+	1+
	<b>S319</b>	filter paper for lateral drainage (50 pcs) (accordingly to specimen dimensions)	S319-01..03	1+	1+	1+
	<b>S320</b>	filter paper for base (100 pcs) (accordingly to specimen dimensions)	S320-01..03	1+	1+	1+
	<b>S122-13</b>	stainless core cutter (accordingly to specimen dimensions)	S122-14..16	1	1	1
	<b>S123-13</b>	dolly for extraction (accordingly to specimen dimensions)	S123-14..16	1	1	1
	<b>S321</b>	drainage burette 10 ml	S322	1	1	1
	<b>S325</b>	nylon tube Ø 6x4 (20 m)		3	3	3
	<b>S326</b>	terminal for connection tube (10 pcs)		1+	1+	1+
	<b>S327</b>	flaring tool		1	1	1
	<b>S328</b>	vaseline oil (1 kg)		1+	1+	1+
	<b>S329</b>	silicon grease (1 kg)		1+	1+	1+
	<b>S330</b>	grease pump		1	1	1
	<b>S331</b>	null displacement valve (spare)		1(opt)	1(opt)	1(opt)
	<b>S332-02</b>	wearable material and recommended spares (accordingly to cell set)	S332-02..05	1	1	1

RECOMMENDED TYPICAL CONFIGURATION OF THE TRIAXIAL SYSTEM WITH THREE CELL  
IN ANALOGUE, DIGITAL AND DIGITAL WITH SUBMERSIBLE LOAD CELL VERSIONS

APPARATUS SECTION	ITEM CODE	ITEM DESCRIPTION	ALTERNATIVE ITEM	3 ANALOGUE CELL SET	3 DIGITAL CELL SET	3 DIGITAL CELL SET with Submersible Load Cell
Hardware Software	<b>S301N</b>	digital triaxial load frame 50 kN		1	1	1
	<b>S301-05</b>	acquisition and data processing		-	1	1
	<b>S301-06</b>	8 channel expansion module		-	1 (opt)	1 (opt)
	<b>S334</b>	Cyber-plus evolution touch screen		-	1	1
	<b>S334-01</b>	8-channel internal module, for system expansion to 16 channels		-	1	1
	<b>S334-11</b>	network connection RJ45 cable		-	1	1
	<b>S334-12</b>	switch to connect from 2 up to 7 Cyber-Plus to the Ethernet network		-	1	1
	<b>S305</b>	triaxial cell dia max. 70 x 140 mm	S306	3	3	3
	<b>S359</b>	3 cell consolidation frame		1	1	1
	<b>S273 KIT</b>	set of slotted weights 50 kg		3	3	3
Measure of Axial force	<b>S335-10N</b>	software triaxlab reports - Matest Made		-	1 (opt)	1 (opt)
	<b>S370-05S</b>	load proving ring 10 kN	S370/1-xxS	1	-	-
	<b>S374</b>	stem mechanical brake device		1 (opt)	-	-
	<b>S337-32</b>	electric load cell 10 kN capacity	S377-31..34	-	1	-
	<b>S337-04</b>	submersible load cell 10 kN	S337-02..05	-	-	1
	<b>S337-21</b>	loading ram for submersible cell		-	-	1
	<b>S337-51</b>	calibration process for load cell		-	1 (opt)	1 (opt)
Measure of Axial strain	<b>S377</b>	dial gauge 25 mm	S379	4	-	-
	<b>S336-12</b>	displacement transducer 25 mm	S336-16	-	4	4
	<b>S336-31</b>	extension cable 5 m	S336-30..32	-	4	4
	<b>S335-15</b>	universal coupling pliers		4	4	4
	<b>S305-05</b>	mounting device for pliers		4	4	4
	<b>S337-51</b>	calibration process for displacement transducer		-	4 (opt)	4 (opt)
	<b>S336-45</b>	gauge block 25 mm	S336-41..47	-	1 (opt)	1 (opt)
De-aired water system	<b>S355</b>	de-airing tank		1	1	1
	<b>V205</b>	vacuum pump		1	1	1
	<b>V205-10</b>	vacuum regulator		1	1	1
	<b>V205-12</b>	moisture filter		1	1	1
Pore pressure system and measure	<b>V230-03</b>	rubber tube 3 m		1	1	1
	<b>S350N</b>	air/water interface pressure system	A144	6	6	6
	<b>S351N</b>	laboratory air compressor 17 bar (only if S350N system is chosen)	V207	1	1	1
	<b>S350-04</b>	membrane for air/water cell (spare) (only if S350N system is chosen)		1 (opt)	1 (opt)	1 (opt)
	<b>S350-05N</b>	pressure regulator (only if S350N system is chosen)		6	6	6
	<b>S355-01</b>	filter unit		1	1	1
	<b>S340</b>	dial gauge unit 4 valves (only if S350N system is chosen)	S342-02 + S342-06	3	3	3
	<b>S345</b>	screw pump (only if S340 is chosen)		3	3	3
	<b>S348</b>	distribution unit		3	3	3
	<b>S350-01</b>	2-way distribution valve		6	6	6
	<b>S336-51</b>	pore pressure transducer 2000 kPa (cell pressure + pore + back pressure)	S336-50	-	9	9
	<b>S336-55</b>	de-airing block		-	9	9
<b>S336-31</b>	extension cable 5 m	S336-30..32	-	9	9	



Measure of Volume change	<b>S356N</b>	digital pore pressure readout		2 (opt)	-	-
	<b>S358</b>	double burette system	S338N	3	-	-
	<b>S377</b>	dial gauge 25 mm (only if S338N system is chosen)		3	-	-
	<b>S335-15</b>	universal coupling pliers (only if S338N system is chosen)		3	-	-
	<b>S338-05</b>	mounting device for pliers (only if S338N system is chosen)		3	-	-
	<b>S338-01 KIT</b>	automatic volume gauge	S338N	-	3	3
	<b>S336-12</b>	displacement transducer 25 mm	S336-16	-	3	3
	<b>S336-31</b>	extension cable 5 m	S336-30..32	-	3	3
	<b>S335-15</b>	universal coupling pliers		-	3	3
	<b>S338-05</b>	mounting device for pliers		-	3	3
	<b>S337-51</b>	calibration process for displacement transducer		-	3 (opt)	3 (opt)
Specimen preparation and Accessories	<b>S310</b>	rubber membrane (10 pcs) (accordingly to specimen dimensions)	S310-01..03	1+	1+	1+
	<b>S311</b>	"O" ring (10 pcs) (accordingly to specimen dimensions)	S311-01..03	1+	1+	1+
	<b>S312</b>	membrane stretcher (accordingly to specimen dimensions)	S312-01..03	1	1	1
	<b>S313</b>	split former (accordingly to specimen dimensions)	S313-01..03	1	1	1
	<b>S313-10</b>	split mould (accordingly to specimen dimensions)	S313-11..13	1	1	1
	<b>S314</b>	top cap with drainage (accordingly to specimen dimensions)	S314-01..03	3	3	3
	<b>S315</b>	base adapter for cell (accordingly to cell model and specimen dimensions)	S315-01..07	3	3	3
	<b>S316</b>	porous disc (2 pcs) for CD/CU/UU tests (accordingly to specimen dimensions)	S316-01..03	3	3	3
	<b>S317</b>	plain disc (2 pcs) for UU test only (accordingly to specimen dimensions)	S317-01..03	1	1	1
	<b>S318</b>	"O" ring for base adapter (accordingly to specimen dimensions)	S318-01..03	1+	1+	1+
	<b>S319</b>	filter paper for lateral drainage (50 pcs) (accordingly to specimen dimensions)	S319-01..03	1+	1+	1+
	<b>S320</b>	filter paper for base (100 pcs) (accordingly to specimen dimensions)	S320-01..03	1+	1+	1+
	<b>S122-13</b>	stainless core cutter (accordingly to specimen dimensions)	S122-14..16	1	1	1
	<b>S123-13</b>	dolly for extraction (accordingly to specimen dimensions)	S123-14..16	1	1	1
	<b>S321</b>	drainage burette 10 ml	S322	1	1	1
	<b>S325</b>	nylon tube Ø 6x4 (20 m)		9	9	9
	<b>S326</b>	terminal for connection tube (10 pcs)		2+	2+	2+
	<b>S327</b>	flaring tool		1	1	1
	<b>S328</b>	vaseline oil (1 kg)		1+	1+	1+
	<b>S329</b>	silicon grease (1 kg)		1+	1+	1+
<b>S330</b>	grease pump		1	1	1	
<b>S331</b>	null displacement valve (spare)		1 (opt)	1 (opt)	1 (opt)	
<b>S332-02</b>	wearable material and recommended spares (accordingly to cell set)	S332-02..05	1	1	1	

## AUTOMATIC DATA ACQUISITION AND PROCESSING SYSTEM FOR GEOTECHNICAL TESTS

S334  
 DATATRONIC 8 CHANNELS CYBER-PLUS EVOLUTION TOUCH SCREEN  
 EXPANDABLE TO 16 CHANNELS



Controller for MATEST equipment or  
 for other manufacturers machines



S334



S301N Triaxial UU - CU - CD tests



S260 Consolidation test



S276 Direct/Residual shear tests



S290 Consolidation frame for shear boxes and consolidation cells



S359 Consolidation frame for triaxial specimens

**S334**
**DATATRONIC 8 CHANNELS CYBER-PLUS EVOLUTION TOUCH SCREEN**
**EXPANDABLE TO 16 CHANNELS**

This unit is designed and produced to satisfy the requirements of all laboratories, from the small, up to the most complex.

8 channels acquisition and processing data system (expandable to 16 channels, see accessory mod. S334-01), colour "Touch Screen" display, it automatically performs test and data processing. Directly connected to PC via USB, it prints the test certificate. Equipped with slots for external Pendrive or SD Card infinite memory supports. Hardware technical details at p. 18.

One or more cyber-plus (8 or 16 ch) can be connected to create a network multichannel system. A flexible, customizable and infinitely expandable solution.

Data collection is completely automatic, improving considerably the productivity and cost effectiveness.

Windows based program with menu driven command selection, is straightforward and easy to follow and does not require a skilled operator.

The system can be used for:

- Oedometer (consolidation) tests
- Direct and residual shear tests (cycle test)
- Triaxial UU, CU, CD tests
- Automatic data acquisition and processing systems permit the utilization of different channels that can be independently calibrated, zeroed and set up in order to visualize the units being measured;
- The appliances contain a modern high speed - high performing 24 bit conversion device;
- The appliances permit to acquire the signals coming from different types of transducers:
- Strain Gauge Bridge and Potentiometric Wide input range available for the electrical signal:  
 $\pm 40 \text{ mV} \dots \pm 3 \text{ V}$
- User interface:  
 Full-color display 320x340 pixel – Touchscreen
- Data storage:  
 The data test can be stored directly into the appliance on a flash memory and be transferred to the PC at the end of the test by USB pendrive or SD card
- Every channel can be set with different sampling modes (linear form, quadratic form, logarithmic form, etc.). The sampling process can be executed with different frequencies: from 50 ms to infinite
- The calibration data are protected by password and they can be transferred to external supports archives.

**Power supply:** 230V 1ph 50Hz

**Dimensions:** 260x260x155 mm

**Weight:** 5 kg approx.

**ACCESSORIES**

**S334-01** 8-CHANNEL INTERNAL MODULE, for system expansion to 16 channels.

**S334-11** NETWORK CONNECTION RJ45 cable.

**S334-12** SWITCH to connect from 2 up to 7 Cyber-Plus (mod. S334) to the Ethernet network.

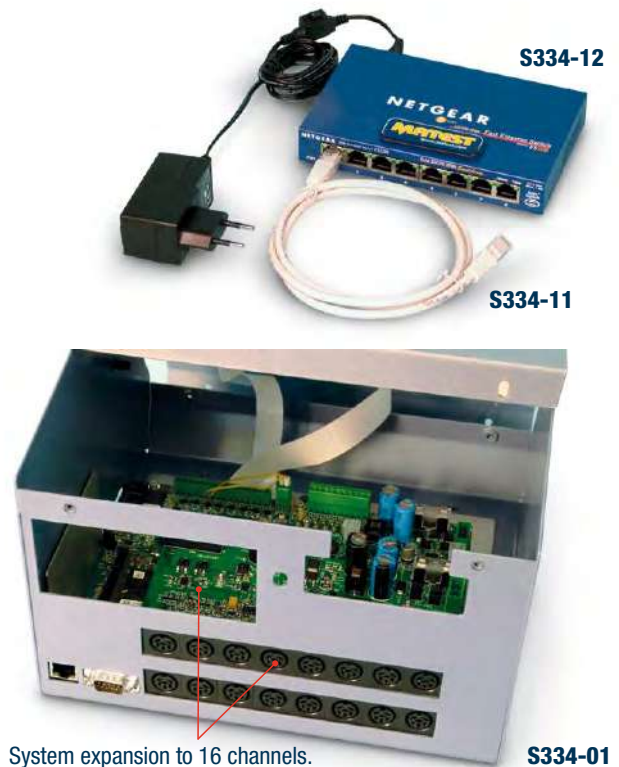

System expansion to 16 channels.

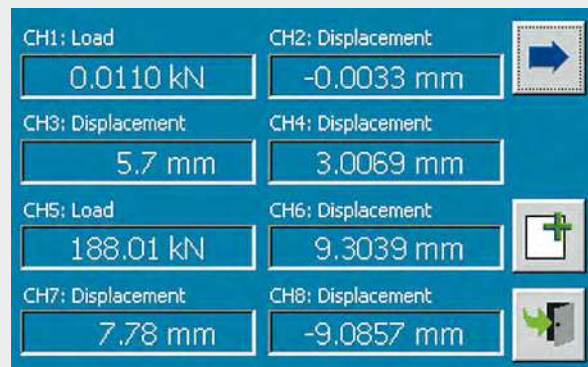

**S334** output channels and readings

## TRIAXLAB AUTOMATED SYSTEM

STANDARDS: BS 1377:7, BS 1377:8 | ASTM D2850, D4767, D7181 | NF P94-070, P94-074 | CEN-ISO-TS 17892



### MAIN FEATURES

- Automatic execution of 5 independent triaxial tests from start to finish.
- Type of tests: total and effective stress, standard stress path, optional KO and optional permeability.
- Servo feedback controlled precision pressure (Pressurematic) generation system.
- Real time graphing and configurable real time transducers.
- Pre-programmed user-friendly “Method files” through the TestLab Software.
- Compact and versatile for improving productivity and cost effectiveness.
- No need of air source.



TriaxLab Automated System

Matest TRIAXLAB is an outstanding system specifically designed for advanced soil testing.

This system can be used from educational to construction engineering laboratories to reduce to the absolute minimum any form of manual intervention.

Based on the unparalleled performance of CDAS and flexibility of TestLab Software, the new MATEST TriaxLab Automated System is the optimized system to perform automatically total and effective triaxial tests such as:

- CD Consolidated Drained test
- CU Consolidated Undrained test
- UU Unconsolidated Undrained test
- Standard stress path
- Optional KO tests
- Optional Permeability tests

The **TRIAXLAB automated system** basically consists of 3 major groups:

- **Load frame and triaxial cell** with accessories
- **Control system** based on the CDAS Control and Data Acquisition System and TestLab Software controlled by PC
- **Data Acquisition System** comprising:
  - 1 load cell for axial force
  - 1 displacement transducer for axial displacement
  - 2 pressure transducers for cell pressure and back pressure
  - 1 pressure transducer for pore pressure
  - 2 Pressurematic for pressure / volume change

To suit the specific customer's requirements the MATEST TriaxLab Automated System basic configuration can be modified by adding or removing the hardware elements which are controlled and monitored under a closed-loop integrated system with the CDAS and TestLab Software.

Pre-programmed "Method files" offer the operator the unique opportunity to run a range of tests without the need for specific computer programming. The possibility to customize the Method files is also given to the operator granting ultimate flexibility and versatility.

## MAIN FEATURES

- **POWERFUL**  
Equipped with Pavetest's leading edge Control and Data Acquisition System (CDAS) and TestLab Software.
- **VERSATILE**  
Designed for routine tests, central laboratories and for research purposes.
- **GREAT EFFICIENCY**  
By working in complete automatic mode, it reduces to absolute minimum the manual intervention.
- **EASY TO USE**  
The system works via the pre-programmed Method Files.
- **FLEXIBLE**  
Multiple triaxial tests with no need for compressed air supply.

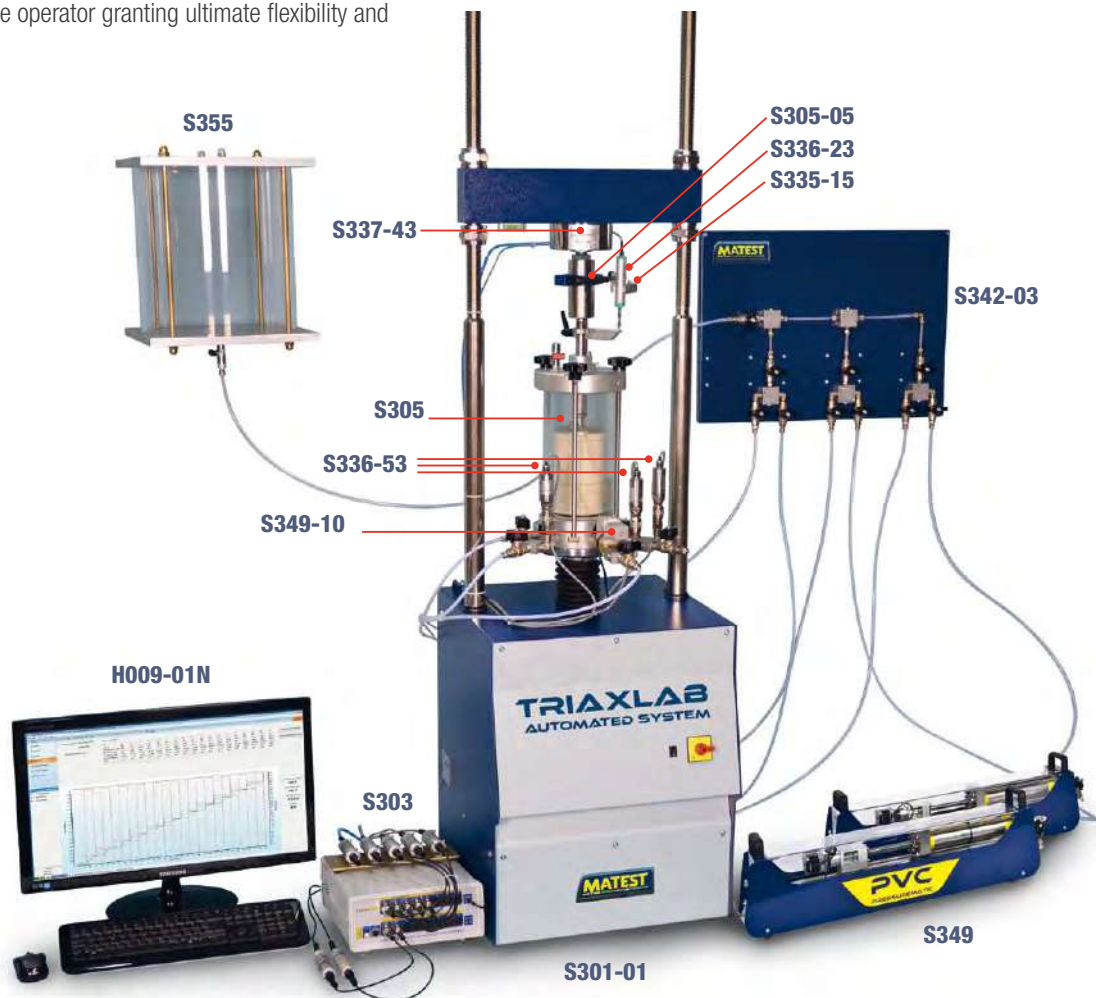

## TRIAXLAB AUTOMATED SYSTEM

### ORDERING INFO:

#### HARDWARE - SOFTWARE

##### S301-01

#### DIGITAL TRIAXIAL LOAD FRAME 50 KN

Technical Specifications:

Maximum load capacity: 50 kN

Infinitesimal testing speed:  
from 0.00001 to 12 mm/min

Minimum vertical clearance: 400 mm

Maximum vertical clearance: 1100 mm

Horizontal clearance: 380 mm

Platen diameter: 177 mm

Power Supply: 230V 1ph 50/60Hz 600W

##### S303

#### CDAS AND TESTLAB SOFTWARE

Technical Specifications:

Acquisition 16 Channels 20 bit resolution

Sampling rate up to 192 kHz  
(all channels)

Smoothing up to 64 times over-sampling

Calibration Automatically on power up

Control Axis 4

Communication USB or Ethernet

Power supply:

90-264 V 50/60 Hz 1 ph 240 W

Dimensions: 100(h) x 310(d) x 250(w) mm

##### S305

#### TRIAXIAL CELL MAX. Ø 70X140 MM

Technical Specifications:

Max. specimen size: mm Ø 70x140

Max. cell pressure: 1700 kPa

Overall dimensions: mm Ø 280x480

Weight: 8 kg approx.

##### S306

#### TRIAXIAL CELL MAX. Ø 100X200 MM

Technical Specifications:

Max. specimen size: mm Ø 100x200

Max. cell pressure: 1700 kPa

Overall dimensions: mm Ø 310x540

Weight: 16 kg approx.

##### S307

#### TRIAXIAL CELL MAX. Ø 150X300 MM

Technical Specifications:

Max. specimen size: mm Ø 150x300

Max. cell pressure: 2200 kPa

Overall dimensions: mm Ø 338x648

Weight: 40 kg approx.

See p. 569

#### MEASURE OF AXIAL FORCE

##### S337-43

#### LOAD CELL 25 KN WITH SIGNAL CONDITIONER

Rated output: 2 mV/V nominal

Accuracy: 0.1%

##### S337-41

#### LOAD CELL 50 KN WITH SIGNAL CONDITIONER

Rated output: 2 mV/V nominal

Accuracy: 0.1%

#### MEASURE OF AXIAL STRAIN

##### S336-23

#### TRANSDUCER TYPE "A" TRAVEL 25 MM WITH SIGNAL CONDITIONER

Independent linearity: <0.3% (0.3 x 10 mm)

Max. displacement speed: up to 10 m/S

 **Note:** For different requirements load cells capacity and transducers stroke or submersible load cells, see page 548

#### ACCESSORIES

##### S305-05

Mounting device of the universal coupling pliers mod. S335-15 to fix the displacement transducer/dial gauge to the Triaxial Cell.

##### S335-15

Universal coupling pliers to hold the transducer/dial gauge. It fits all Matest displacement transducers and dial gauges (from dia. 8mm to 20mm).

##### S337-51

Calibration process of one force, strain and pressure device that is combined with the CDAS control and data acquisition system.

##### S335-15



##### S305-05



##### S305

with accessories

##### S336-23



##### S306

#### DEAIRED WATER SYSTEM

##### S355

#### DE-AIRING TANK 20 LITRES CAPACITY

It produces de-aired water when connected to the vacuum pump. It is a perspex tank with an inlet water valve and an outlet air valve.

Tank capacity: 20 litres.

Dimensions: 320x320x520 mm

Weight: 15 kg approx.



S355

#### ACCESSORIES

##### V205

#### VACUUM PUMP

To produce vacuum up to of 0,1 mbar (see p. 597)

##### V205-10



V205

##### V205-10 - V205-12

#### VACUUM REGULATOR

It is supplied with vacuum gauge, control valve, suction filter and moisture trap.

##### V230-03

Rubber tube. Suitable for vacuum, 3 m

#### MEASURE OF PORE PRESSURE SYSTEM AND VOLUME CHANGE

##### S349

#### PRESSUREMATIC PVC FOR AUTOMATIC PRESSURE AND VOLUME CONTROL

Technical Specifications:

Output pressure: 3500 kPa

Volume capacity: 250 cc. Details at p. 565

#### NEEDED ACCESSORIES

**S336-53** Pressure transducer 2000 kPa with signal conditioner.

**S336-55** De-airing block for pressure transducer

**S349-10** Solenoid valve

#### OPTIONAL ACCESSORIES

**S342-03** 3 ways water distribution panel

**S303**  
**CDAS – CONTROL AND DATA ACQUISITION SYSTEM**

**S303** CDAS 16 Channels

**MAIN FEATURES**

- Directly communicates with the TestLab software, providing automatic test execution and data processing.
- Compact high reliability data acquisition and control.
- Up to 5 kHz data acquisition and feedback control provides excellent waveform fidelity.
- Normalized ( $\pm 10V$ ) analog data acquisition inputs provide flexibility to use any transducer in any channel.
- Software and test methods expandable for future requirements.

Pavetest's compact Control and Data Acquisition System (CDAS) delivers unparalleled performance, real time control and ultimate versatility in acquisition and provide a flexible and user friendly testing solution for soils when coupled with the Matest TriaxLab Automated System and the Cyclic TriaxLab Automated one.

The CDAS provides excellent waveform fidelity from integrated acquisition and control functions, with low level sampling at speeds of up to 192,000 samples per second simultaneously on all channels (using up to 64x oversampling).

S303 CDAS provides an optimized solution for the TriaxLab Automated Systems. The CDAS works with close synchronization to the TestLab software providing dynamic and precise servo control of the TriaxLab frame, Pressurematic systems. Acquisition and control is provided for:

- Vertical load and displacement
- Confining and back pressure (through the solenoid valve)
- Volume change and water pressures
- Local strain

**THECNICAL SPECIFICATIONS**
**S303**  
**16 Channel CDAS**

Acquisition 16 CH, 20 bit resolution

- Sampling rate up to 192 kHz (all channels)
- Smoothing up to 64 times over-sampling for low noise performance
- Calibration automatically on power up
- Control Axis 4
- Communication USB or Ethernet

**Power supply:** 90-264V 50-60Hz 1pPh 240W

**Dimensions:** 100 (h) x 310 (d) x 250 (w) mm

**Weight:** 2 kg approx.

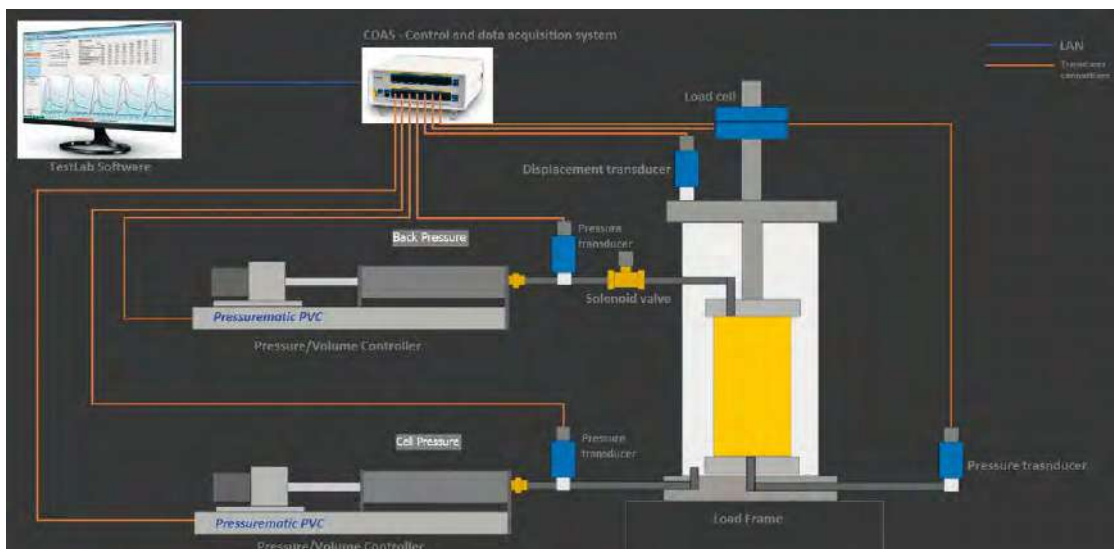

TriaxLab conceptual schematic

## S349 PRESSUREMATIC PVC

### MAIN FEATURES

- Compact stainless steel construction
- Powered and controlled by the CDAS and TestLab Software
- Closed loop control up to 3500 kPa
- 0.001 kPa pressure and 0.0003 cc volume resolution
- High volume capacity: 250 cc
- Graduated scale for approximate volume change indication
- No need of air source

Pressurematic is the new solution for geotechnical laboratories demanding automatic pressure and volume control. By using a servo stepper motor directly controlled by the TestLab software and CDAS, Pressurematic allows to build confining pressure and back pressure up to 3500 kPa. The unparalleled performance of the CDAS allows to regulate the pressure under a closed loop control regulated to 0.1 kPa.

The operation is continuously monitored by the TestLab software, thus catering to all levels of operator experience.

Standard effective stress tests require 2 Pressurematic units: one for cell pressure and the other for back pressure which can be also used to measure the change in volume of the specimen to 0.0003 cc. The latter is provided with a solenoid valve directly installed on the triaxial cell and used to open and close the pressure line whenever it is needed.



S349

### THECNICAL SPECIFICATIONS

- Output pressure: 3500 kPa
- Volume capacity: 250 cc
- Pressure accuracy: 0.25% of full scale
- Pressure resolution: 0.001 kPa
- Volume resolution: 0.0003 cc
- Closed loop control of pressure regulated to 0.1 kPa
- Closed loop control of volume regulated to 0.0003 cc
- Maximum operational speed: 8 cc/s

**Power supply:** 24V DC 1A powered from CDAS

**Dimensions:** 900x110x230 mm

**Weight:** 7 Kg approx.

### NEEDED ACCESSORIES

- S336-53** Pressure transducer up to 2000 kPa
- S336-55** De-airing block for pressure transducer
- S349-10** Solenoid valve

### OPTIONAL ACCESSORIES

- S342-03** 3 ways water distribution panel



S342-03



## TRIAXLAB AUTOMATED SYSTEM: suggested typical configuration

Apparatus Section	Item Code	Item Description	Quantity
<b>Hardware Software</b>	<b>S301-01</b>	Triaxial load frame 50kn for triaxlab automated system	1
	<b>S303</b>	16 ch CDAS & testlab software	1
	<b>S305</b>	Triaxial cell max $\varnothing$ 70x140 mm	1
<b>Measure of Axial force</b>	<b>S337-41</b>	Load cell 50 kn capacity with signal conditioner	1
	<b>S337-51</b>	Calibration process for load cell	1
<b>Measure of Axial Strain</b>	<b>S336-23</b>	Transducer type "a" travel: 25 mm with signal conditioner	1
	<b>S337-51</b>	Calibration process for displacement transducer	1
	<b>S305-05</b>	Mounting device on triaxial cell	1
	<b>S335-15</b>	Universal coupling pliers for transducer	1
<b>De-aired water system</b>	<b>S355</b>	De-airing tank	1
	<b>S355-01</b>	Filter group (water trap)	1
	<b>V205</b>	Vacuum pump	1
	<b>V205-10</b>	Vacuum regulator	1
	<b>V205-12</b>	Condensed water trap	1
	<b>V230-03</b>	Rubber tubing for vacuum, 3 metres	1
<b>Measure of pore pressure and volume change</b>	<b>S349</b>	Pressurematic PCV	2
	<b>S336-53</b>	Pressure transducer 2000 kpa with signal conditioner	3
	<b>S337-51</b>	Calibration process for pressure transducers	3
	<b>S336-55</b>	De-airing block	3
	<b>S342-03</b>	3 ways water distribution pannel	1
	<b>S349-10</b>	Solenoid valve	1
<b>Specimen preparation and Accessories</b> <small>(also available with <math>\varnothing</math> 38, 70, 100 mm see page 546)</small>	<b>S310-01</b>	Rubber membrane $\varnothing$ 50 mm (10 pcs)	2
	<b>S311-01</b>	Sealing ring $\varnothing$ 50 mm (10 pcs)	1
	<b>S312-01</b>	Membrane stretcher $\varnothing$ 50 mm	1
	<b>S313-01</b>	Split former $\varnothing$ 50 mm	1
	<b>S313-11</b>	Split mould $\varnothing$ 50 mm	1
	<b>S314-01</b>	Top cap with drain $\varnothing$ 50 mm	1
	<b>S315-01</b>	Plinth $\varnothing$ 50 mm for cell mod. s305	1
	<b>S316-01</b>	Porous disc $\varnothing$ 50 mm (2 pcs)	1
	<b>S317-01</b>	Plein disc $\varnothing$ 50 mm (2 pcs)	1
	<b>S318-01</b>	"O" ring for plinth $\varnothing$ 50 mm	1
	<b>S319-01</b>	Filter paper drain $\varnothing$ 50 mm (50 pcs)	1
	<b>S320-01</b>	Filter paper for base $\varnothing$ 50 mm (100 pcs)	1
	<b>S122-14</b>	Hollow punch $\varnothing$ 50 mm - triaxial	1
	<b>S123-14</b>	Tamper $\varnothing$ 50 mm - triaxial	1
	<b>V205-11</b>	Special oil for pumps	1
	<b>S325</b>	Nylon tube $\varnothing$ 4 mm (20 mt)	2
	<b>S326</b>	Terminal for connection tube (10 pcs)	2
	<b>S327</b>	Flaring tool	1
	<b>S329</b>	Water-repellent grease (1000 g)	1
	<b>S330</b>	Grease pump	1
	<b>S328</b>	Vaseline oil 1000 ml	1
	<b>S332-04</b>	Spares and wearable 1 cell automatic	1+

## CYCLIC TRIAXLAB AUTOMATED SYSTEM

STANDARDS: ASTM D7181 | ASTM D2850 | ASTM D3999 | ASTM D4767 | ASTM D5311 | BS 1377:7 | BS 1377:8 | AASHTO T307-9



**ALSO AVAILABLE  
IN VERSION  
ELECTROMECHANICAL**

### MAIN FEATURES

- Automatic execution of static and dynamic triaxial tests including effective stress and standard stress path.
- 4 axis control and 16 channel control Data Acquisition System.
- Servo feedback controlled precision pressure (Pressurematic) generation system.
- Digital Servo-Pneumatic Control to provide accurate loading wave shapes up to 70 Hz.
- Real time charting.
- Compact and versatile for improving productivity and cost effectiveness.
- Pre-programmed user friendly "Method files" through the TestLab Software.
- Possibility to upload user-defined wave-shapes (e.g. earthquakes time series) through Replay Editor.
- Fully configurable to suit a large range of testing applications including maximum shear modulus calculation through bender elements option.
- Programmable Dashboard display showing real-time system status and test result.



DTS-9 Cyclic TriaxLab Automated System

The Cyclic TriaxLab automated with its innovative features represents the most ideal solution for modern laboratories that need to investigate the effects of vibration and dynamic loading for soil and unbound granular materials.

Typical applications include:

- Civil engineering including seismic and blasting analysis
- Environmental engineering
- Construction and architectural design
- Advanced research on soils

Based on the 4 axis control and 16 channel control and Data Acquisition CDAS, Matest Cyclic TriaxLab has provision for:

- Vertical load tension/compression up to 9 kN
- Vertical displacement up to 50 mm
- Cell pressure up to 2000 KPa
- Back pressure up to 2000 KPa

The Cyclic TriaxLab automated system is subdivided into 3 major groups similarly to the TriaxLab Automated System:

- **Fully digital controlled load frame** and fit for purpose Triaxial cell with accessories
- **Control system** based on the CDAS
- **Data Acquisition System** comprising:
  - 1 submersible load cell for axial force
  - 3 pressure transducers for cell pressure, back pressure and pore pressure
  - 2 Pressurematic for pressure/volume change

To suit the specific customer's requirements the MATEST Cyclic TriaxLab Automated System basic configuration can be modified by adding or removing the hardware elements which are controlled and monitored under a closed-loop integrated system with the CDAS and TestLab Software.

Pre-programmed "Method files" offer the operator the unique opportunity to run a range of tests without the need for specific computer programming. The possibility to customize the Method files is also given to the operator granting ultimate flexibility and versatility.

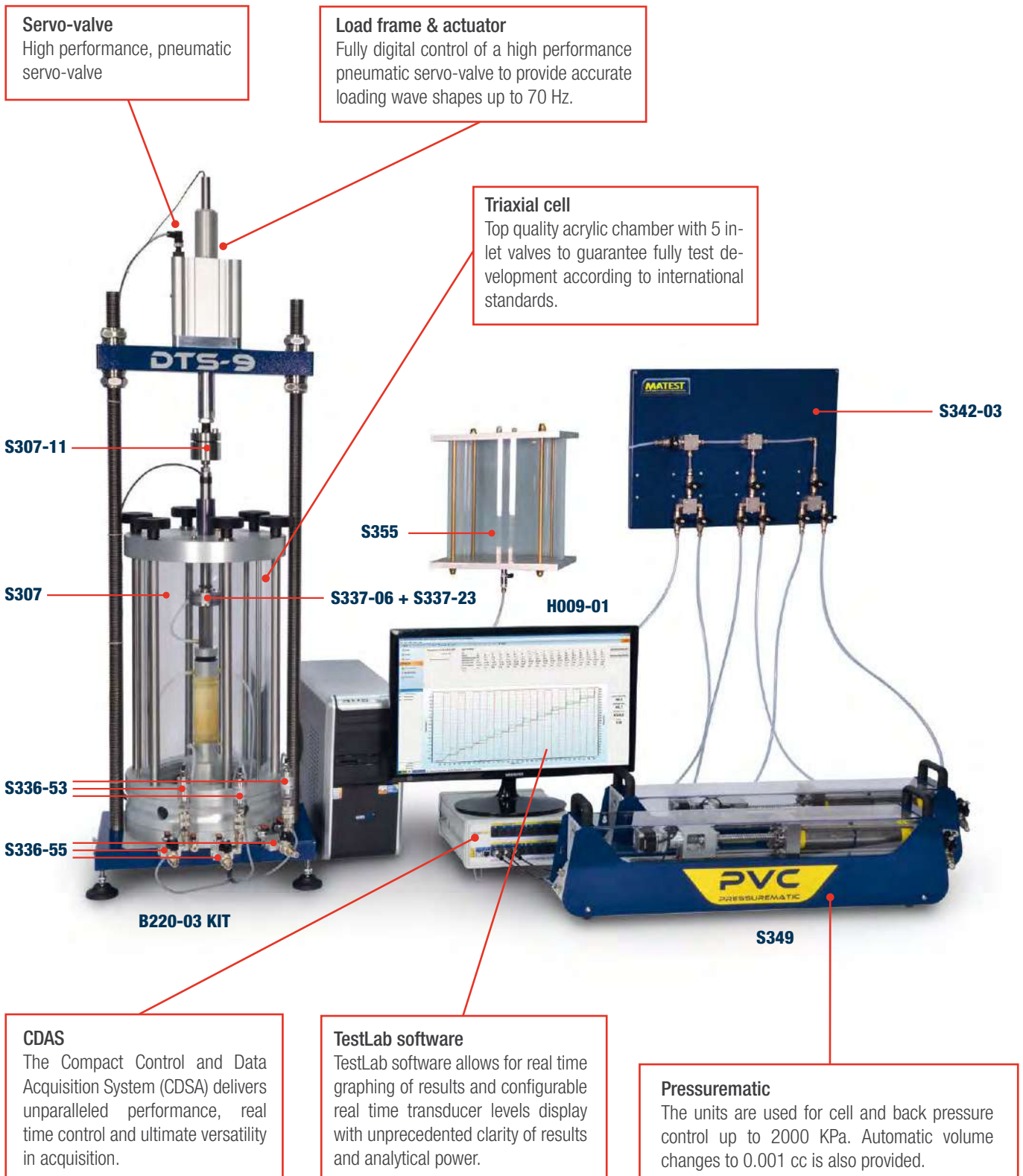

#### Servo-valve

High performance, pneumatic servo-valve

#### Load frame & actuator

Fully digital control of a high performance pneumatic servo-valve to provide accurate loading wave shapes up to 70 Hz.

#### Triaxial cell

Top quality acrylic chamber with 5 inlet valves to guarantee fully test development according to international standards.

#### CDAS

The Compact Control and Data Acquisition System (CDSA) delivers unparalleled performance, real time control and ultimate versatility in acquisition.

#### TestLab software

TestLab software allows for real time graphing of results and configurable real time transducer levels display with unprecedented clarity of results and analytical power.

#### Pressurematic

The units are used for cell and back pressure control up to 2000 KPa. Automatic volume changes to 0.001 cc is also provided.

## CYCLIC TRIAXLAB AUTOMATED SYSTEM ORDERING INFO:

### HARDWARE - SOFTWARE

#### B220-04 KIT DTS9 WITH MANUAL CROSSHEAD

The machine includes:

##### B220-14

20 kN load frame with manual crosshead  
9 kN servo-pneumatic actuator with its LVDT,  
50mm stroke, 70 Hz frequency.

**Power supply:** 90-264V 50-60Hz 1ph 240W

**Dimensions:** 1262(h)x400(d)x470(w)

**Weight:** 80 kg load frame

##### S303

16 Channel Control and Data Acquisition  
System (CDAS) and TestLab software.

For technical specifications, see p. 564

##### B270-12

Air reservoir assembly with membrane dryer.  
It requires pressurized air, minimum 7 bar  
(not included).

##### S307

#### TRIAXIAL CELL MAX Ø 150X300 MM

Technical specifications:

- Max specimen mm Ø 150x300
- Max cell pressure 2200 kPa
- Overall dimensions mm Ø 338x648
- Weight 40 kg approx.

Accessories listed at p. 546

**Note:** Triaxial cell for cyclic tests  
max. 100x200 mm available on request.



S307 with accessories

### MEASURE OF AXIAL FORCE

#### S337-06 SUBMERSIBLE LOAD CELL 10 KN WITH SIGNAL CONDITIONER

■ Rated output 2 mV/V nominal

■ Accuracy 0.1%

**Note:** For different requirements load  
cells capacity and transducers stroke or  
submersible load cells, see p. 548

#### ACCESSORIES FOR TRIAXIAL CELL

**S337-23** Loading ram for the submersible  
load cell

**S307-05** Transducers holder ring

**S307-10** Vacuum generator

**S307-19** Vacuum adaptor

**S307-11** Alignment coupler assembly

**S307-12** Spherical exclusion

**S307-13** Base pedestal spacer

#### OPTIONAL ACCESSORIES

BENDER ELEMENTS KIT for the evaluation of  
the stiffness of a soil starting from the meas-  
urement of the maximum shear modulus  
(G<sub>max</sub>). The Kit includes:

**S307-08** Picoscope

**S307-07** T-4001 waveforms transformer

**S307-03** Kit of upper and lower bender  
holders

**S307-22 | 32 | 42 | 52**

Base pedestal for bender element  
Ø 38 | 50 | 70 | 100 mm

**S307-23 | 33 | 43 | 53**

Top platen for bender element  
Ø 38 | 50 | 70 | 100 mm

**S307-24 | 34 | 44 | 54**

Pair of porous disc  
Ø 38 | 50 | 70 | 100 mm



Bender elements KIT

### DEAIRED WATER SYSTEM

#### S355 DE-AIRING TANK 20 LITRES CAPACITY

It produces de-aired water when connected  
to the vacuum pump. It is a Perspex tank with  
an inlet water valve and an outlet air valve.  
Tank capacity: 20 litres.

**Dimensions:** 320x320x520 mm

**Weight:** 15 kg approx.

#### ACCESSORIES

##### V205

VACUUM PUMP

To produce vacuum up to of 0.1 mbar  
(see p. 597)

##### V205-10 - V205-12

VACUUM REGULATOR

It is supplied with vacuum gauge, control  
valve, suction filter and moisture trap.

##### V230-03

Rubber tube. Suitable for vacuum, 3 m

### MEASURE OF PORE PRESSURE SYSTEM AND VOLUME CHANGE

#### S349 PRESSUREMATIC PVC FOR AUTOMATIC PRESSURE AND VOLUME CONTROL

Output pressure: 3500 kPa

Volume capacity: 250 cc

For Technical Specifications, see p. 565

#### NEEDED ACCESSORIES

**S336-53** Pressure transducer 2000 kPa  
with signal conditioner.

**S336-55** De-airing block for pressure  
transducer

**S349-10** Solenoid valve

#### OPTIONAL ACCESSORIES

**S342-03** 3 ways water distribution panel

## TESTLAB SOFTWARE ➤ NEW

Developed with ultimate flexibility in mind, TestLab test and control software caters to all levels of operator experience. By using pre-programmed **Method files**, an inexperienced operator can run a range of international test methods without the need for any programming. Moreover, a test **Wizard**, available with popular tests, can guide the operator step by step based on a “recipe book” approach. Most importantly, the experienced engineer and/or researcher need not be constrained by the functions and analysis in the method files provided. The operator may clone, modify and/or generate his/her own method file to suit their specific requirements. The Excel based data analysis offers the operator the flexibility to implement alternative analysis and customize reporting facilities. TestLab allows for real time graphing of results and configurable real time transducer levels display with unprecedented clarity of results and analytical power. These features make the TestLab software the optimized solution for the new Matest Triaxlab Automated and Cyclic Systems. It is provided with CDAS mod. S303 see p. 564.

### MAIN FEATURES

- Pre-programmed Method files based on international test methods for complete control of triaxial testing for saturation, consolidation and shearing phases.
- Integrated data results post processing feature with MS Excel.
- Standard and user customizable test reporting.
- Real time graphing of results and configurable real time transducer.
- Flexible and user-friendly with unprecedented clarity of results and analytical power.
- Automatic B value measurement.
- Automatic backpressure solenoid valve control.



## TESTLAB, A NEW APPROACH

TestLab is an open architecture user programmable software application. Our engineers have taken the time to review all the relevant international test standards and used TestLab “Test Designer” to program method files according to these standards. Basically, any of these tests can be designed, cloned and/or modified by the user within TestLab. The user is no longer restricted to the test applications provided at time of purchase the possibilities are only limited by the skill and imagination of the user.

### TESTLAB MANAGER

The TestLab materials testing software is designed to interface with the CDAS and a wide range of Pavetest machines including Automatic TriaxLab system. A TestLab Manager interface allows users to easily and efficiently locate the necessary method files to load and execute.

The method files for soil testing include: saturation, consolidation, CU compression test, CD compression test, UU compression test in accordance with:

- ASTM 04767, ASTM D7181, BS 1377: part 8
- ASTM D2850, BS 1377: part 7



TestLab Manager

### TEST METHOD SELECTION

The operator can run pre-programmed Method files, in accordance to the requested Standards, or configure an application test and then save that configuration to a customised Method file. This includes the real-time transducer and calibration allocations, comprising all the stresses, strain and volume changes for automatic triaxial testing; control parameters for the Pressurematic; solenoid valves and triaxial frames; terminal conditions as for instance end of stroke or maximum capacity limits, test pause features for the Pressurematic live control, additional options to hold the stress and strain applied to the specimen.

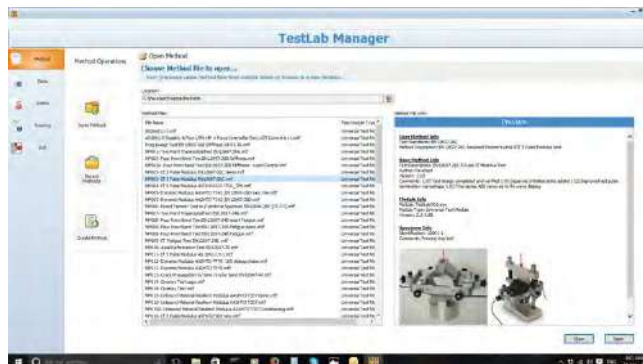

Selection of Method Files

## TESTLAB, USER FRIENDLY INTERFACE FOR SOIL TESTING ▶ NEW

### TEST WIZARD

The wizard section provides a prompted menu approach to running a test. The user is driven to enter information throughout a series of easy steps. Examples of input information for consolidated drained compression test include:

- Specimen Information: axial gauge length (mm), Consolidated Height (mm), Consolidated Area (mm<sup>2</sup>), Membrane Modulus (MPa), Membrane thickness (mm), Filter Paper K<sub>fp</sub> (kN/mm), Filter Paper Perimeter P<sub>fp</sub> (mm), Axial Strain Limit (%), Break Detect (% drop)
- Loading sequences settings: confining pressure (kPa), Road Seal Diameter (mm), back pressure valve, Loading rate (%/min)
- Test data: Axial Load (kN), Axial Deformation (mm), Total and Effective Stress (kPa), Back and Pore Pressure (kPa), Volume Change (cc) and Axial Strain (%)
- Real time tuning (PID control increments) and chart controls (Corrected Deviator Stress, Axial Stress, Radial Stress, Induced Pore Pressure, Effective Radial Stress)

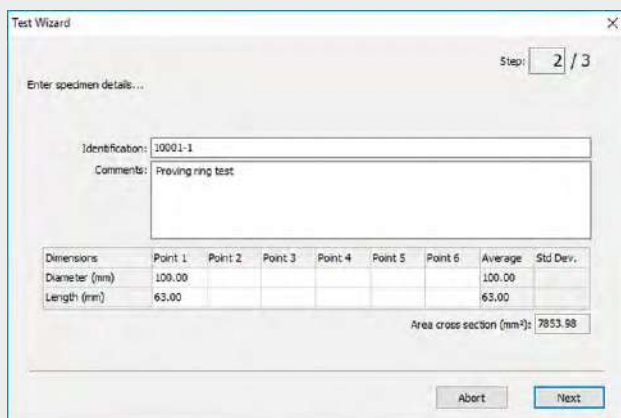

Dimensions	Point 1	Point 2	Point 3	Point 4	Point 5	Point 6	Average	Std Dev.
Diameter (mm)	100.00						100.00	
Length (mm)	63.00						63.00	
							Area cross section (mm <sup>2</sup> ):	7853.98

User guided Test wizard

### TESTLAB UNIVERSAL TEST

The Test Data section displays run-time information, such as the loading time, cycle count, transducer readings (force, displacement, pressure), stress calculations.

Volume changes, B valve, consolidation parameters (t<sub>100</sub>), stress path, optional K<sub>0</sub> and permeability coefficients.

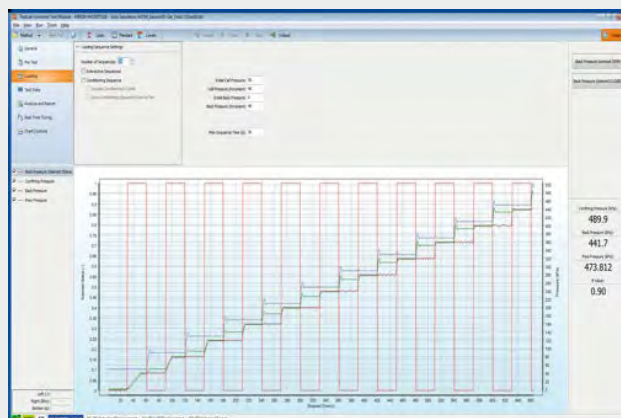

ASTM D4767, D7181-11 Automatic Saturation

### REAL TIME DASHBOARD DISPLAY

For the automatic and cyclic triaxial tests, Pavetest provides the user with an alternative, simpler and more intuitive representation of the current status of both machine and test method. This dashboard display feature of TestLab shows real time transducer levels, computed data and charted data before, during and after the test has completed.



Typical dashboard screen

### POST PROCESSING

All TestLab Method file tests provide the facility to send the data directly to an Excel workbook including test input and results data. This facility provides a means of efficiently post processing raw data results and customizing reports from within Excel and optionally displaying summary result in TestLab.

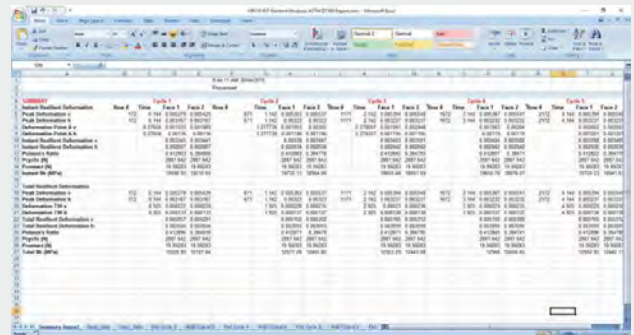

Post processing summary results

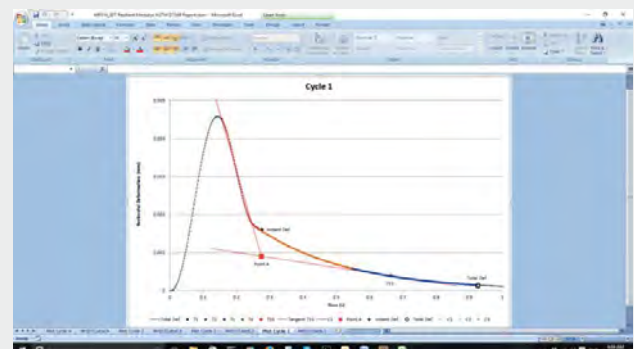

Excel post processing report

CYCLIC TRIAXLAB AUTOMATED SYSTEM: suggested typical configuration

Apparatus Section	Item Code	Item Description	Quantity
Stretcher, actuator and controller	B220-04-KIT	Loading frame	1
		Triple axis control & data acquisition system (CDAS)	1
		9 KN Servo-Pneumatic actuator assembly, 50 mm stroke, LVDT $\pm$ 50 mm calibrated over $\pm$ 37.5 mm	1
Triaxial cells with accessories	S307	Triaxial cell for specimens up to 150x300 mm	1
	S337-06	Submersible load cell calibrated to -5/+5 kn	1
	S337-23	Loading ram for the submersible load cell (for S307)	1
	S307-05	Transducers holder ring	1
	S307-10	Vacuum generator	1
	S307-19	Vacuum adaptor	1
	S307-11	Alignment coupler assembly	1
	S307-12	Spherical extension	1
	S307-13	Base pedestal spacer	1
	S337-51	Calibration process for load cell	1
	Water pressure system, measure of pressure and measure of volume	S342-03	3 Ways distribution panel w/out regulators
S349		Pressurematic PVC	2
S349-10		Solenoid valve	1
S336-53		Pressure transducer 2000 kpa with ILC	3
S336-55		De-airing block	3
S355		De-airing tank	1
S355-01		Filter group (water trap)	1
V205		Vacuum pump 1 stage air: 4.5 m <sup>3</sup> /h	1
S337-51		Calibration process for pressure transducers	3
V205-10		Vacuum regulator	1
V205-12		Condensed water trap	1
V230-03		Rubber tubing for vacuum, 3 meters	1
Bendel elements kit		S307-08	Picoscope
	S307-07	T-4001 waveforms transformer	1
	S307-03	Kit of upper and lower bender holders	1
	S307-22/32/42/52	Base pedestal for bender element $\varnothing$ 38/50/70/100 mm	1
	S307-23/33/43/53	Top platen for bender element $\varnothing$ 38/50/70/100 mm	1
	S307-24/34/44/54	Pair of porous disc $\varnothing$ 38/50/70/100 mm	1
Accessories for specimen preparation, $\varnothing$ 38 mm   $\varnothing$ 50 mm   $\varnothing$ 70 mm   $\varnothing$ 100 mm   $\varnothing$ 150 mm	S307-20/30/40/50/60	Vacuum plate 38/50/70/100/150 mm specimen	1
	S307-21/31/41/51/61	Vacuum top platen 38/50/70/100/150 mm specimen	1
	S310, S310-01/02/03/04	Rubber membrane $\varnothing$ 38/50/70/100/150 mm (10 pcs)	1
	S311, S311-01/02/03/04	Sealing ring $\varnothing$ 38/50/70/100/150 mm (10 pcs)	1
	S312, S312-01/02/03/05	Membrane stretcher $\varnothing$ 38/50/70/100/150 mm	1
	S313, S313-01/02/03/04	Split former $\varnothing$ 38/50/70/100/150 mm	1
	S313-10/11/12/13/14	Two -part split mould $\varnothing$ 38/50/70/100/150 mm	1
	S315-10/11/12/13/14	Plinth $\varnothing$ 38/50/70/100/150 mm for cell mod. s307	1
	S316, S316-01/02/03/04	Porous disc $\varnothing$ 38/50/70/100/150 mm (2 pcs)	1
	S317, S317-01/02/03/04	Plein disc $\varnothing$ 38/50/70/100/150 mm (2 pcs)	1
	S318, S318-01/02/03/04	"O" Ring tool for plinth $\varnothing$ 38/50/70/100/150 mm	1
	S319, S319-01/02/03/04	Filter paper drain $\varnothing$ 38/50/70/100/150 mm (50 pcs)	1
	S320, S320-01/02/03/04	Filter paper for base $\varnothing$ 38/50/70/100/150 mm (100 pcs)	1
	S122-13/14/15/16	Hollow punch $\varnothing$ 38/50/70/100 mm - triaxial	1
	S123-13/14/15/16	Tamper $\varnothing$ 38/50/70/100 mm - triaxial	1
Other elements	S325	Nylon tube 4 mm $\varnothing$ (20 mt)	1
	S326	Terminal for connection tube (10 pcs)	1
	S327	Flaring tool	1
	S328	Vaseline oil, 1000 ml	1
	S329	Water-repellent grease (1000 g)	1
	S330	Grease pump	1
S332-04	Spares and wearable 1 cell automatic	1	

## LOAD PROVING RINGS

Used for load compression measurement applied by the testing machine.

Made from hardened alloy steel, they are chrome-coated and complete with upper and lower coupling blocks having M10 female gas thread.

The accuracy is  $\pm 1\%$  of applied load and repeatability is within 0.2%

Each ring is supplied complete with calibration chart made by PC

Large range from 0.5 kN to 100 kN in the following versions:

**S370 Serie** with dial gauge 0.01 mm graduation

**S371 Serie** with dial gauge 0.001 mm graduations

**S372 Serie** with digital gauge 0.001 mm graduation, including battery and RS232 port to PC connection.

Max. Capacity kN	Dial gauge 0.01 mm	Dial gauge 0.001 mm	Digital gauge 0.001 mm - RS232	Height mm	Weight kg
0.5	<b>S370</b>	<b>S371</b>	<b>S372</b>	210	1.6
1	<b>S370-01</b>	<b>S371-01</b>	<b>S372-01</b>	210	1.7
2	<b>S370-02</b>	<b>S371-02</b>	<b>S372-02</b>	210	1.8
3	<b>S370-03</b>	<b>S371-03</b>	<b>S372-03</b>	210	1.9
5	<b>S370-04</b>	<b>S371-04</b>	<b>S372-04</b>	210	2
10	<b>S370-05</b>	<b>S371-05</b>	<b>S372-05</b>	210	2.2
15	<b>S370-06</b>	<b>S371-06</b>	<b>S372-06</b>	210	2.5
20	<b>S370-07</b>	<b>S371-07</b>	<b>S372-07</b>	210	3
30	<b>S370-08</b>	<b>S371-08</b>	<b>S372-08</b>	210	3.5
40	<b>S370-09</b>	<b>S371-09</b>	<b>S372-09</b>	210	3.9
50	<b>S370-10</b>	<b>S371-10</b>	<b>S372-10</b>	210	7.2
60	<b>S370-11</b>	<b>S371-11</b>	<b>S372-11</b>	210	7.7
100	<b>S370-12</b>	<b>S371-12</b>	<b>S372-12</b>	210	10.2



### ACCESSORIES

**Stop electrical safety device** to stop the machine when reaching the max. capacity of the ring, to prevent any overload damage.

For ordering you have to add the letter "S" at the end of the load ring code.

Ex.: S370-09S

**S374** Stem mechanical brake device, it holds the max. reached value on the dial gauge, with manual zero setting.

**S374-02** Ball seat, complete with connector, for an articulated coupling to the testing machine.

### SPARE

**S373-05** COUPLING DEVICE between the dial indicator and the load ring.



## DIAL INDICATORS

Foreseen on different machines and equipments described in this catalogue.

Diameter of the dial: 60 mm, 80 mm mod. S379-01 with clockwise rotation.

Model	Travel mm	Division mm
S375	5	0.001
S375-01	12	0.002
S376	10	0.01
S377	25	0.01
S378	30	0.01
S379	50	0.01
S379-01	100	0:01

## DIGITAL DIAL INDICATORS

Including battery and RS 232 port for PC connection.

Model	Travel mm	Division mm
S382-01	12.7	0.001
S383	25.4	0.001

## ACCESSORY

**S382-13** CABLE to connect S382-01 and S383 to PC through USB port for direct visualization and recording of the measurement.



## ACCESSORIES

- S380** MAGNETIC DIAL HOLDER, comprising a fix rod and an adjustable rod.  
MAGNETIC BASE FORCE 25 kg approx.
- S374** STEM BRAKE DEVICE to hold the max. reached value on the dial gauge.
- S380-01** REAR MOUNT of the dial indicator.

## S390 CALIBRATION UNIT FOR EXTENSOMETERS AND DIAL GAUGES

This Appliance can be used to check the displacement calibration of extensometers, dial gauges, transducers etc.

Composed by:

Aluminium frame,  
Delicate moving saddle,  
Digital micrometric head 50 mm travel,  
resolution 0.001 mm,  
error limit  $\pm 0.003$  mm  
Sample holder to fit dial gauges with stem having 8 mm diameter (different sample holders are available on demand).

**Weight:** 18 kg approx.



**S390**



**S390N + S336-12**

## S390N CALIBRATION UNIT FOR TRANSDUCERS AND DIAL GAUGES

Simple model, stainless steel and aluminium made, complete with mechanical micrometer with friction 50 mm travel and 0.001 mm resolution. Sample holders to fit dial gauges with stem having 8 mm diameter and transducers having 19 mm diameter.

**Weight:** 2 kg approx.

# OUR CLIENTS ARE OUR BEST ADVERTISEMENT.





# SECTION V

## GENERAL EQUIPMENT



This section proposes a wide range of laboratory equipment and accessories that cannot be located in a specific application, but they are used for general purposes and are suitable to perform properly different measuring procedures of liquids and solids, weighing, temperature, containers, still, pH, chemicals, reagents etc. from scales to pumps, from thermometers to laboratory glassware, Matest complete its range of equipment for testing building materials.



## MECHANICAL BALANCES ORIGINAL OHAUS

### AVAILABLE MODELS

#### V014

DIAL-O-GRAM Balance 310 g capacity x 0.01g sensitivity, triple beam with vernier. Includes stainless steel pan, zero adjustment.

**Weight:** 3 kg

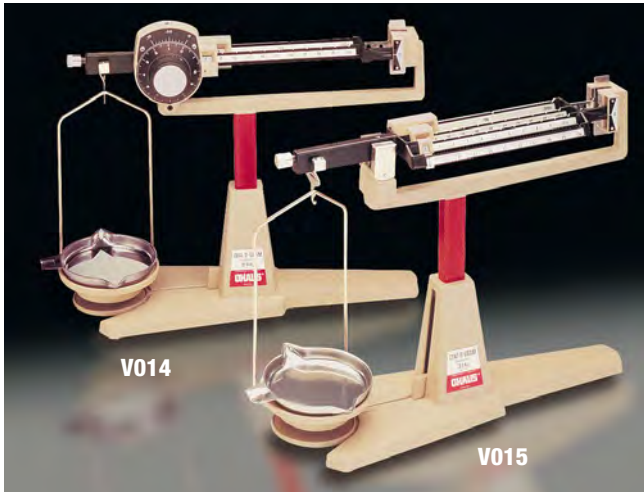

#### V015

CENT-O-GRAM Balance 311 g capacity x 0.01 g. sensitivity, four beams. Includes stainless steel pan, zero adjustment. **Weight:** 3 kg

#### V016

TRIPLE BEAM Balance 2610 capacity x 0.1 g sensitivity. Includes stainless steel pan, set of weights. **Weight:** 4 kg

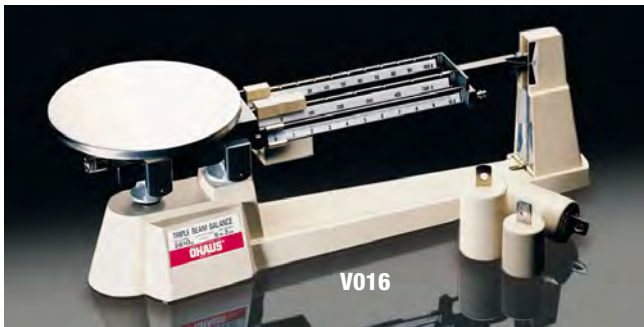

#### V017

HEAVY DUTY SOLUTION Balance 20 kg capacity x 1 g sensitivity. Complete with set of weights, sliding weight for tare up to 2270 g, holding plate 280 mm diameter. **Weight:** 20 kg approx.



## ROTARY AUTOMATIC SCALES

Five pointer turns allow a larger amplitude of the subdivision. Double quadrant and under quadrant sicking for multiples. Oil oscillation shock-absorber, with exterior adjustment. Displacement of the head in all positions without angulation limit. Pan, mass-produced, stainless steel.



V057

Models	Capacity	Sensitivity
V057	60 kg	20 g
V059	150 kg	50 g

#### V051

### BATCHING SCALE

Capacity: 200 kg

Sens. 100 g

Completely produced in painted metal, double oscillation, case in strong profiled, platform in reinforced steel. The sliding weight and accessories are brass made while the rod is from chromed steel.

Supplied complete with set of weights.



V051

## SEMI-AUTOMATIC ZERO-CENTERING BALANCE

This scale with central zero is particularly suitable for predetermined weights. It has two pans; the sample is placed on the main pan and the weights are placed on the other until the pointer indicates the dial. Weights are not included and should be ordered separately.

### MODELS

#### V031

Capacity 10 kg sens. 1 g

Dial -100 +100 g

#### V034

Capacity 30 kg sens. 5 g

Dial -250 +250 g



V031

## WEIGHTS FOR BALANCES

### V036

SET OF BRASS WEIGHTS comprised in a wooden box.

Total weight reaching 1000 g. The set is formed by: 1x500 g, 1x200 g, 2x100 g, 1x50 g, 1x20 g, 2x10 g, 1x5 g, 2x2 g, 1x1 g

<b>E066-02</b>	Weight	100 g, brass calibrated
<b>V036-02</b>	Weight	0.5 kg, cast iron, calibrated
<b>V037</b>	Weight	1 kg, cast iron, calibrated
<b>V038</b>	Weight	2 kg, cast iron, calibrated
<b>V039</b>	Weight	5 kg, cast iron, calibrated
<b>V040</b>	Weight	10 kg, cast iron, calibrated
<b>V040-01</b>	Weight	20 kg, cast iron, calibrated



V036-02...V040-01

## STANDARD CALIBRATION WEIGHTS

Used for the periodic verification of the balance readings. CLASS: M1  
Made in Italy

The weights are also available with ACCREDIA Calibration Certificate.



V035-03

Code	Weight	Plastic box
V035-01	50 g	yes
V035-02	100 g	yes
V035-03	200 g	yes
V035-04	500 g	yes
V035-05	1 kg	yes
V035-06	2 kg	yes
V035-07	5 kg	yes
V035-08	10 kg	yes

## MOISTURE DETERMINATION BALANCES

### AVAILABLE MODELS

#### V023-01

MOISTURE BALANCE, 160 g capacity x 0.001/0.01 g sensitivity with tare up to 10 g  
Samples are dried by a infrared lamp with adjustable heat control. A built-in-timer 0-61 min. switches off the heater at the end of the drying cycle which is signaled by a bell.  
Moisture loss percentage and residual mass are read directly from the lighted scale.

**Power supply:** 230V 1ph 50-60Hz

#### V023-02

MOISTURE BALANCE, as above, but 120 g capacity x 0.001/0.01 g sensitivity.

#### V023-03

MOISTURE BALANCE, as above, but 60 g capacity x 0.001/0.01 g sensitivity.



V023-01...V023-03

## ELECTRONIC ANALYTICAL BALANCES

### AVAILABLE MODELS

#### V065-02

ELECTRONIC ANALYTICAL BALANCE  
Capacity: 250 g Readability: 0.1 mg  
Tolerance:  $\pm 0.2$  mg  
Outer keyboard with direct reading on a wide LCD display.  
Data interface: RS 232  
Single pan  $\varnothing$  80 mm  
Tare range: by subtraction up to full capacity.  
Dust proof plexiglass cover. Ideal for very accurate weightings and for heat of hydration cement tests.

**Power supply:** 230V 50-60Hz 1ph

**Dimensions:** 315x225x330 mm

**Weight:** 10 kg approx.



V065-02...V065-03

#### V065-03

ELECTRONIC ANALYTICAL BALANCE, as above, but 220 g capacity x 0.1 mg readability.

**ELECTRONIC PRECISION TOP LOADING AND PLATFORM BALANCES**

Designed for laboratory general purposes, most of them are fitted with under balance weighting facility for specific gravity tests, and RS232 for PC or printer connection.

Sturdy and precise, they are fitted with strain gauge cells and large backlit display.

Immediate and automatic zeroing and tare, automatic changeover of scale sensitivity (dual range models only).

Power supply and standard - optional accessories are listed for each model of balance and described in the legend.

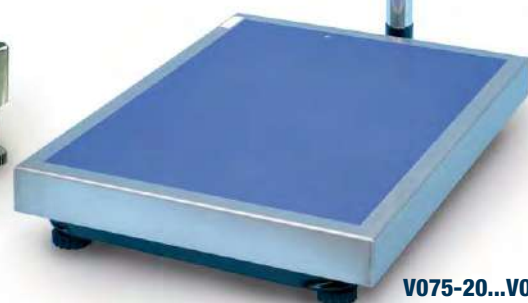
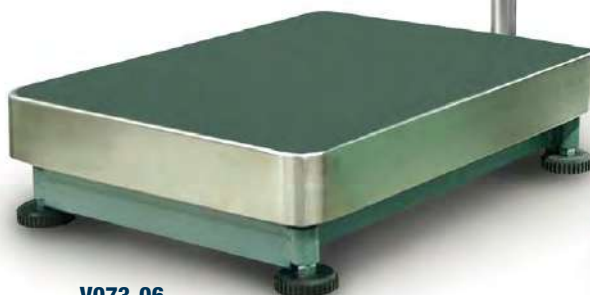
**V070-02...V070-06****V071-10...V072-02****V072-06N, V075-11...V075-13****V072-09, V073-04****V073-01****V075-02...V075-04****V075-06****V073-06****V075-20...V075-22**

Model	Capacity	Readability	Pan dimensions mm	Standard accessories	Optional accessories
V070-02	210 g	0.001 g	Ø 110	A + F + G	H
V070-05	310 g	0.001 g	Ø 110	E + F + G	H
V070-06	500 g	0.001 g	Ø 110	A + F + G	H
V071-10	2200 g	0.01 g	Ø 160	A + F + G	H
V071-07	3100 g	0.01 g	Ø 160	A + F + G	H
V071-11	4200 g	0.01 g	Ø 160	A + F + G	H
V072-02	800/5500 g	0.01/0.1 g	Ø 160	A + F + G	H
V072-06N	15 kg	0.1 g	320x210	E + F + G	H
V072-09	4500/16000 g	0.1/1 g	320x210	A + F + G	H
V073-01	16 kg	0.1 g	320x360	E + F	H
V073-04	4500/32000 g	0.1/1 g	320x210	A + F + G	H
V073-06	60 kg	1 g	425x600	E + G	H
V075-02	300 g	0.005 g	Ø 120	E + G	H
V075-03	600 g	0.01 g	Ø 120	E + G	H
V075-04	1500 g	0.01 g	Ø 120	E + G	H
V075-06	3000 g	0.05 g	125x145	E + G	H
V075-11	6 kg	0.1 g	225x300	E + F + G	H
V075-12	15 kg	0.2 g	225x300	E + F + G	H
V075-13	30 kg	0.5 g	225x300	E + F + G	H
V075-20	60 kg	2 g	450x600	E	
V075-21	150 kg	5 g	450x600	E	
V075-22	300 kg	10 g	450x600	E	

## LEGEND

## STANDARD ACCESSORIES

- A = Power supply only 230V 1ph 50-60Hz  
E = Power supply: rechargeable batteries and also 230V 1ph 50-60Hz  
F = Under balance weighting facility for specific gravity tests  
G = RS 232 port

## OPTIONAL ACCESSORIES

- H = **V074-12** Printer complete with connection cable  
**V074-13** Traceable calibration certificate



**V085**
**SPECIFIC GRAVITY FRAME**

(BOUYANCY BALANCE SYSTEM)

STANDARDS: EN 12697, EN 1097-6 | EN 12390:7

ASTM C127, C128 | AASHTO T84 | BS 812:2, 1881:114

Used for specific gravity determination of concrete, aggregates etc. To be used with a suitable electronic balance fitted with an under-hook facility.

Robust steel frame made, it incorporates on its lower part a platform adjustable in height, holding a water container, and allowing the specific gravity test. The balance is not included and must be ordered separately.

**Dimensions:** 510x510x1150 mm

**Weight:** 50 kg approx.

**ACCESSORIES**
**V085-01** CRADDLE for holding concrete cube and cylinder specimens

**V041** DENSITY BASKET, stainless steel, Ø 200x200 mm, mesh 3.35 mm

**V086 KIT**
**SPECIFIC GRAVITY KIT**

Used for specific gravity determination of solid materials. Simplified and economical solution.

The kit is composed of:

**V086** Support bridge frame with hook rod.

**V042** Density tank, plastic, 370x370x330 mm

**V041** Density basket, stainless steel, Ø 200x200 mm, mesh size 3.35 mm

To be used with a suitable electronic balance fitted with under-hook facility.

**ACCESSORY**
**V085-01** CRADDLE for holding concrete cube and cylinder specimens.

**DENSITY BASKETS**

STAINLESS STEEL MADE

**AVAILABLE MODELS**
**V041** DENSITY BASKET  
 STANDARDS: ASTM C127 | AASHTO T85 | BS 812:2  
 Used for specific gravity tests, Ø 200x200 mm, mesh size 3.35 mm (N° 6 ASTM). Weight 1.5 kg approx.

**B017-01** Ø 130x135 mm, mesh size 0.063 mm

**B017-02** Ø 130x135 mm, mesh size 0.4 mm

**B017-04** Ø 130x135 mm, dual mesh size 0.063 and 0.4 mm

**A103** Ø 120x160 mm, mesh size 3.35 mm

**A103-01** Ø 95x120 mm, mesh size 1.18 mm

**A103-02** Ø 95x120 mm, mesh size 0.600 mm

**A103-03** Ø 65x80 mm, mesh size 0.150 mm

**V042**

 DENSITY TANK PLASTIC,  
 dimensions 370x370x330 mm

**Weight:** 3 kg approx.

**V042**

## LABORATORY GLASSWARE

### MEASURING CYLINDERS

available in the following models:

Capacity	transparent plastic spouted	glass with stopper	opaque plastic spouted	transparent glass spouted
10 ml	<b>V098</b>	<b>V099</b>	<b>V100</b>	<b>V101</b>
25 ml	<b>V098-01</b>	<b>V099-01</b>	<b>V100-01</b>	<b>V101-01</b>
50 ml	<b>V098-02</b>	<b>V099-02</b>	<b>V100-02</b>	<b>V101-02</b>
100 ml	<b>V098-03</b>	<b>V099-03</b>	<b>V100-03</b>	<b>V101-03</b>
250 ml	<b>V098-04</b>	<b>V099-04</b>	<b>V100-04</b>	<b>V101-04</b>
500 ml	<b>V098-05</b>	<b>V099-05</b>	<b>V100-05</b>	<b>V101-05</b>
1000 ml	<b>V098-06</b>	<b>V099-06</b>	<b>V100-06</b>	<b>V101-06</b>
2000 ml	<b>V098-07</b>	<b>V099-07</b>	<b>V100-07</b>	<b>V101-07</b>



### PYKNOMETERS

Pyrex glass, with ground-in-perforated stopper.

Capacity	Mouth 29 mm	Wide Mouth 50 mm
250 ml	<b>V105-03</b>	=
500 ml	<b>V105</b>	<b>V105-04</b>
1000 ml	<b>V105-01</b>	<b>V105-05</b>
2000 ml	<b>V105-02</b>	<b>V105-06</b>
3000 ml	=	<b>V105-08</b>

### BEAKERS

pyrex glass with spout. Squat form.

Model	Capacity
<b>V104</b>	25 ml
<b>V104-01</b>	50 ml
<b>V104-02</b>	100 ml
<b>V104-03</b>	250 ml
<b>V104-04</b>	600 ml
<b>V104-05</b>	1000 ml
<b>V104-06</b>	2000 ml
<b>V104-07</b>	5000 ml



### PYKNOMETERS

STANDARD: EN 1097-6

Borosilicate glass, complete with capillary tube, stopper and funnel, used to determine the voids and bulk density of aggregates.

Model	Capacity
<b>V103</b>	500 ml
<b>V103-01</b>	1000 ml
<b>V103-02</b>	2000 ml

### CONICAL FLASKS, ERLLENMEYER

Pyrex glass wide mouth.

Model	Capacity
<b>V106</b>	100 ml
<b>V106-01</b>	250 ml
<b>V106-02</b>	500 ml
<b>V106-03</b>	1000 ml
<b>V106-04</b>	2000 ml



## FILTER FLASKS

Pyrex glass, for Vacuum filtering.

Model	Capacity	Perforated bung with glass tube
V107	250 ml	V107-11
V107-01	500 ml	V107-12
V107-02	1000 ml	V107-13
V107-03	2000 ml	V107-14

## SPECIFIC GRAVITY GAY-LUSSAC BOTTLES

Model	Capacity
V108	25 ml
V108-01	50 ml
V108-02	100 ml
V108-03	250 ml



## VOLUMETRIC FLASK

Borosilicate glass, with plastic stopper  
STANDARDS: BS-ISO 1042 | ASTM D854

Model	Capacity
V109	100 ml
V109-01	250 ml
V109-02	500 ml
V109-03	1000 ml
V109-08	2000 ml

## VOLUMETRIC FLASK

Unstoppered, borosilicate glass.

Model	Capacity
V109-04	100 ml
V109-05	250 ml
V109-06	500 ml
V109-07	1000 ml
V109-09	2000 ml

## REAGENT BOTTLES

Model	Capacity
V108-10	250 ml
V108-11	500 ml
V108-12	1000 ml



## GRADUATED IMPURITIES TEST BOTTLES

Stoppered, pyrex glass

Model	Capacity	Standard
S132-01	500 ml	ASTM C40
S132-02	500 ml	UNI 8020-14
S132-03	1000 ml	ASTM C40



## WEIGHTING BOTTLES

Glass, with cover

Model	Dimensions
V110	Ø 50 x 30 mm
V110-01	Ø 25 x 40 mm
V110-02	Ø 70 x 50 mm
V110-03	Ø 40 x 60 mm

## GLASS FUNNELS

Model	Diameter
V119	25 mm
V119-01	50 mm
V119-02	100 mm
V119-03	150 mm

## V111 HUBBARD SPECIFIC GRAVITY BOTTLE

STANDARD: ASTM D70 | EN ISO 3838

Capacity: 24 ml

## V111-01 HUBBARD-CARMICK SPECIFIC GRAVITY BOTTLE

STANDARD: ASTM D70 | EN ISO 3838

Capacity: 25 ml

## V124 DROPPING BOTTLE

Capacity: 100 ml



## WATCH GLASS (beaker cover)

Model	Diameter
V115	100 mm
V115-01	130 mm

## PETRI DISH with cover, pyrex glass

Model	Diameter
V123	100 mm
V123-01	60 mm

**MEASURING PIPETTES**, MOHR type, graduated

Model	Capacity	Sub-divisions
V142	1 ml	0.01 ml
V142-01	5 ml	0.1 ml
V142-02	10 ml	0.1 ml
V142-03	25 ml	0.1 ml
V142-04	50 ml	0.1 ml
V142-05	100 ml	0.2 ml

**GRADUATED BURETTES**, BENT

Soda glass with stopcock

Model	Capacity	Sub-divisions
V143	25 ml	0.1 ml
V143-01	50 ml	0.1 ml
V143-02	100 ml	0.2 ml

**GRADUATED BURETTES**, STRAIGHT

Soda glass with stopcock

Model	Capacity	Sub-divisions
V143-05	10 ml	0.02 ml
V143-06	25 ml	0.1 ml
V143-07	50 ml	0.1 ml
V143-08	100 ml	0.2 ml

**V138****FILTER FUNNEL**, PYREX GLASS

Ø 90 mm for particle analysis tests to BS 1377



V138

**V300-15****DISSICATORS SALTS**, SILICA GEL

Box of 1000 g



V147

V147-01

V143

V142

V143-05

**V147****STIRRING ROD**, glass, Ø 8 mm x 250 mm long. Pack of 10**V147-01****MARKING PENCIL**, glass. Pack of 12**DESICCATORS BOROSILICATE GLASS**

Complete with perforated porcelain plate.



A039

A035

Without vacuum		With vacuum	
A035	Ø 200 mm	A039	Ø 200 mm
A036	Ø. 250 mm	A040	Ø 250 mm
A036-01	Ø 300 mm	A040-01	Ø 300 mm

## PLASTIC PRODUCTS



## DECANTERS, polypropylene made

Model	Capacity
V102-01	500 ml
V102-02	1000 ml
V102-03	2000 ml
V102-04	3000 ml

## S157-05

**BEAKER**, graduated, plastic, 2000 ml capacity.  
STANDARD: EN 933-9

## WASH BOTTLES, plastic

Model	Capacity
V120	100 ml
V120-01	250 ml
V120-02	500 ml
V120-03	1000 ml

## FUNNELS, plastic

Model	Diameter
V135	100 mm
V135-01	140 mm
V135-02	210 mm

## FUNNELS, wide mouth, plastic

Model	Diameter	
V136	max. 80 mm	min. 15 mm
V136-01	max. 120 mm	min. 30 mm
V136-02	max. 150 mm	min. 35 mm

## BOTTLES, plastic, wide mouth stoppered

Model	Capacity
V118	250 ml
V118-01	500 ml
V118-02	1000 ml
V118-03	2000 ml
V121	5 litri
V121-01	10 litri



## V128

**BUCKET** plastic, with handle  
capacity 12 litres



## BOXES plastic, stacking

Model	Dimensions	Capacity
V127	380x280x200 mm	20 litri
V127-01	560x330x280 mm	50 litri
V127-02	650x380x320 mm	80 litri



## SAMPLE BAGS

Heavy plastic, pack of 100 pcs

Model	Dimensions
V145-10	25x35 cm
V145-11	40x60 cm



## PORCELAIN PRODUCTS

### MORTAR AND PESTLE, porcelain

Model	Diameter	Height
V112	100 mm	60 mm
V112-01	125 mm	65 mm
V112-02	150 mm	76 mm
V112-03	180 mm	92 mm
V112-04	200 mm	100 mm

### V113

#### RUBBER HEADED PESTLE

For soil mortar conforming to ASTM D421, BS 1377:2, BS 1924:1

### EVAPORATING DISHES, porcelain, with spout

Model	Diameter
V114-01	80 mm
V114-02	100 mm
V114-03	120 mm
V114-04	160 mm
V114-05	210 mm
V114-06	254 mm

### V114-10

#### SILICA EVAPORATING DISH

Ø 130 mm x 30 mm high.

Capacity: 160 ml



- V117** PORCELAIN CRUCIBLE, 30 ml squat form
- V117-01** PORCELAIN LID for V117
- V117-02** PORCELAIN CRUCIBLE, 50 ml squat form
- V117-03** PORCELAIN LID for V117-02

- V117-04** PLATINUM CRUCIBLE 25 ml capacity, Ø 35x38 mm weight 19 g, thickness 0.25 mm

- V117-05** PLATINUM CRUCIBLE 25 ml capacity, Ø 35x40 mm, weight 30 g, thickness 0.39 mm



**V117-05**

### V140

**BUCHNER FUNNEL**, porcelain, 115 mm diameter for use with Ø 110 mm filter paper.



**V148****WEATHER STATION** for external use.

Comprising: aneroid barometer, min/max thermometer, hair hygrometer.

**V148-01****ANEMOMETER DIGITAL CUPS, PORTABLE**

for direct reading of wind speed.

Data logger: 100 points.

Cups system, highly sensible.

Functions: MIN, MAX and HOLD.

Large LCD display with Auto Power Off.

Measuring range: 0.9 to 35 m/s; resolution: 0.1 m/s; precision:  $\pm 2\%$

Measuring systems: m/s, km/h, knots, mp/h, ft/min, knots.

Feeding: 4 batteries AAA, 1.5V

**Weight:** 180g

**V148****V148-01****V167**

**RAIN GAUGE**, for measuring rain fall. Simple model in plastic material

**V167-01**

**RAIN GAUGE**, for measuring rain fall; professional model, brass made. Capacity 250 cc corresponding to 25 ml of rain with 1 mm resolution.

**V168**

**THERMOHYGROGRAPH**, for external use.

Simultaneous recording of temperature and humidity on the same chart.

Temperature range:  $-35\text{ }^{\circ}\text{C}$   $+45\text{ }^{\circ}\text{C}$

Humidity range: 0 - 100%

Time scale: 24 hours or 7 days.

Spring operated. Supplied complete

**Dimensions:** 280x150x250 mm

**Weight:** 3 kg

**V168****V167****V167-01****SPARES**

**V168-02** Diagrams for thermohygrograph mod. V168.  
Pack of 55

**V168-03** Diagrams for thermohygrograph mod. V168-01.  
Pack of 55

**V168-04** Writing pen for thermohygrograph.  
Pack of 4

**V169**

**HAIR HYGROMETER**,  
range 0 to 100%

**V169****V168-01**

**THERMOHYGROGRAPH**, internal use, same to mod. V168 but with temperature range 0  $+40\text{ }^{\circ}\text{C}$ .

Battery operated



## DIGITAL THERMOMETERS

Complete with depth stainless steel probe, for temperature measurements of liquid, fluid, semisolid, granular materials, air. The probe is directly connected to the digital unit.

Model	Temp. range °C	Resolution °C	Accuracy °C	Probe dimensions Ø x length
V150	-50 +150	0.1	± 0.3	3x105 mm
V151	-50 +220	0.1	± 0.3	5x125 mm
V152	-40 +550	1	± 2	3x130 mm

### V153

**DIGITAL THERMOMETER**, including remote probe connected to the instrument with a cable 1 metre long.

Temperature range: -50 +150 °C

Resolution: 0.1 °C. Accuracy: ± 0.3 °C

Stainless steel probe Ø 3x160 mm

### V154

#### DIGITAL MICROPROCESSOR THERMOMETER

Rugged, easy to use portable instrument with K type sensor for high temperature measurements, it is equipped with a membrane keyboard and microprocessor with memory functions of: hold, min/max temperatures measured in the cycle, readings in °C or °F.

Dual temperature range: -50 to +200 °C resol. 0.1 °C  
+200 to +1350 °C resol. 1 °C

Accuracy: ± 0.5% full scale

Power supply: 1x9 V battery with 500 hours use

Supplied **without** probe to be selected and ordered separately.

## ACCESSORIES

Stainless steel probes, complete with 1 metre cable and connector

**V154-01** PENETRATION PROBE Ø 3x120 mm

Max temperature: 900 °C

**V154-02** SURFACE PROBE, Ø 16x260 mm

Max temperature: 650 °C

**V154-03** AIR PROBE, Ø 3x245 mm. Max temperature: 300 °C

**V154-04** GENERAL PURPOSE PENETRATION PROBE,

Ø 5x220 mm

Max temperature: 900 °C

**V154-05** K-TYPE THERMOCOUPLE 5 m long

**V154-06** COUPLING UNIT



**C216**  
**FOUR CHANNELS THERMOMETER** k-type thermocouple with SD card data recorder for precast concrete. Technical data and accessories: see p. 338

### V155

#### INFRARED THERMOMETER

To measure surface temperatures without touching the object.

Measuring range: -50 °C +750 °C

Resolution: 0.1 °C up to 200 °C

Functions: Hold and autoswitch-off.

Battery type: 9V



## DIAL THERMOMETERS

For temperature measurement of freshly mixed concrete, bituminous mixtures and general purpose use. Stainless steel made, the terminal part of the stem in **pointed** to get easier the penetration into the material.

Model	Range °C	Sub-divisions °C	Dial Ø	Stem length mm
<b>V160</b>	-40 +40	1	50 mm	250
<b>V160-01</b>	0 +60	1	50 mm	250
<b>V160-02</b>	0 +100	2	50 mm	250
<b>V160-03</b>	0 +250	5	50 mm	250
<b>V160-04</b>	0 +300	5	50 mm	250
<b>V160-06</b>	0 +250	5	75 mm	600



**V160...V160-04**



**V160-01**



**V160-06**

## ASTM, IP, NF THERMOMETERS

Model	Range °C	Graduation °C	ASTM	IP
<b>B057-08</b>	23 / 27	0.1		38C
<b>B063-01</b>	-2 / 300	1	7C	5C
<b>B064-03</b>	150 / 175	0.5	13C	47C
<b>B069-11</b>	-2 / 400	1	8C	6C
<b>B072-01</b>	-2 / 80	0.2	15C	60C
<b>B072-02</b>	30 / 200	0.5	16C	61C
<b>B077-02</b>	-38 / 30	0.5		42C
<b>B082-01</b>	18 / 28	0.2	23C	
<b>B082-02</b>	39 / 54	0.2	24C	
<b>B082-03</b>	95 / 105	0.2	25C	
<b>B082-04</b>	0 / 55	0.2	NF T66-020	
<b>B083-07</b>	0 / 44	0.2		8C
<b>B086-10</b>	-6 / 400	2.0	11C	28C
<b>B088-12</b>	58.5 / 61.5	0.1	47C	
<b>B088-13</b>	133.5/136.5	0.1	110C	
<b>B089</b>	19 / 27	0.1	17C	
<b>B089-01</b>	34 / 42	0.1	18C	23C
<b>B089-02</b>	49 / 57	0.1	19C	
<b>B089-03</b>	57 / 65	0.1	20C	
<b>B089-04</b>	79 / 87	0.1	21C	
<b>B089-05</b>	95 / 103	0.1	22C	
<b>B092-10</b>	-5 / 110	0.5	9C	15C
<b>B092-11</b>	-20 / 50	0.5	57C	
<b>B094-10</b>	90 / 370	2.0	10C	16C



**B057-08...B094-10**

### V161-01

DIAL THERMOMETER, range 0+200 °C for surface measurements.

## ARMOURED THERMOMETERS, pocket size

Model	Range °C	Graduation °C
<b>V162</b>	0...100	1
<b>V162-01</b>	0...200	2

### V163

Max./Min. Thermometer range -30 °C +50 °C



**V163**

**THERMOMETERS** glass stem and mercury system, for general laboratory use.

Model	Range °C	Graduation °C
<b>V164</b>	-5 + 50	0.5
<b>V164-01</b>	-10 + 100	1
<b>V164-02</b>	-10 + 200	1
<b>V164-03</b>	-10 + 300	1



**V164...**

**V162**

**V170  
STOP WATCH**

Digital, non magnetic, having also watch functions.  
Precision 0.1 second.

**V170-01  
STOP WATCH**

Mechanical dial type, non magnetic. Precision 0.1 second.

**V171  
TIMING DEVICE**

From 0 to 60 minutes, with alarm.

**V166-01N  
CONDUCTIVITY METER – THERMOMETER**

Digital, portable. Used for site and laboratory measurements of the conductivity in soils.

Measuring scale: 0 - 4000  $\mu\text{S}/\text{cm}$  - resolution 1  $\mu\text{S}/\text{cm}$  - accuracy 1%

Temperature in  $^{\circ}\text{C}$  and  $^{\circ}\text{F}$ ., range 0 – 50  $^{\circ}\text{C}$  resolution 0.1  $^{\circ}\text{C}$

Calibration and temperature compensation: automatic.

Use conditions: 0 to 50  $^{\circ}\text{C}$ , R.H. 95%

Feeding: battery

**Dimensions:** 50x196x21 mm

**Weight:** 74g

**SOIL HYDROMETERS**

**V172** Range 0.995 - 1.038 g/ml, div. 0.001 - 151 H

**V172-02** Range -5 + 60 g/litre - 152 H

**V172-03N** Range 0.995 - 1.030 g/ml - BS 1377 - long stem

**V172-04** Range 1.000 to 1.200 g/ml for additives

**V172-05** Range 1200 to 1300 g/ml for aggregates. EN 1367-2

**V165  
THERMO-HYGROMETER**

Digital, portable, with detachable probe, it measures and displays in a short time both relative humidity and temperature.

Range: R.H. 20.0 to 95.0% - resolution 0.1% - accuracy  $\pm 4\%$

$^{\circ}\text{C}$  0.0 to 60.0 - resolution 0.1  $^{\circ}\text{C}$  - accuracy  $\pm 0.5\%$

Battery: 1x9 V

**Dimensions:** 185x82x45 mm

**Weight:** 400 g



**V173-01**

BUNSEN BURNER, universal, with air control.  
IT CANNOT BE SOLD IN the european community.

As an alternative:

**V173-01CE**

BUNSEN BURNER, universal, with air control. Complete with gas-stop valve controlled by a flame sensor and maximum thermostat with reset button.

It can be sold in the european market, but not usable in closed spaces.

**V173-02** Tripod Ø 100 x 150 mm

**V173-05** Tripod Ø 120 x 220 mm

**V173-06** Tripod Ø 150 x 230 mm

**V173-03** Iron wire gauze, 150 mm square with ceramic centre

**V173-04** Iron wire gauze, 200 mm square with ceramic centre

**V174** CRUCIBLE TONGS

**V175** VERNIER CALIPER, 0-150 mm x 0.02 mm

**V175-01** VERNIER CALIPER, 0-205 mm x 0.02 mm

**V175-02** DIGITAL VERNIER CALIPER, 0-200 mm x 0.01 mm  
Readings in mm and inch.

**V175-03** DIGITAL VERNIER CALIPER, 0-153 mm x 0.01 mm

**V175-04** DIGITAL VERNIER CALIPER, 0-300 mm x 0.01 mm

**V176** STEEL FOLDING RULE, 2 metres long

**V176-01** STEEL RULE, 300 mm long, 0.5 mm grad.

**V176-02** STEEL RULE, 500 mm long, 0.5 mm grad.

**V177** WORKING SAFETY GLOVES

**V177-01** NEOPRENE GLOVES



**V178** SOFT BRUSH, for cleaning sieves etc.

**V178-01** FINE WIRE BRUSH

**V178-03** BOTTLE BRUSH Ø 50 mm

**V179** BRISTLE, round, Ø 35 mm soft hair

**V179-01** BRISTLE, flat 62 mm soft hair

**V179-02** SIEVE BRUSH, double-ended, brass/nylon

**V179-03** SIEVE BRUSH, double-ended, soft/hard nylon

**V179-04** SIEVE BRUSH, fine brass

**V179-05** SOFT HAIR BRUSH, Ø 3 mm - BS812

**V179-06** BRISTLE, flat, 60 mm, nylon



## METAL CONTAINERS AND PRODUCTS

## MIXING BOWLS, stainless steel

Model	Diameter
V116-03	160 mm
V116	240 mm
V116-01	290 mm
V116-02	340 mm



## V112-05

## MORTAR AND PESTLE, stainless steel, Ø 135 mm

## TINS, with or without cover

- V122** Ø 55 x 36 mm aluminum, with cover
- V122-01** Ø 55 x 65 mm aluminum, with cover
- V122-02** Ø 75 x 50 mm aluminum, with cover
- V122-03** Ø 57 x 32 mm aluminum, without cover
- V122-04** Ø 45 x 13 mm aluminum, without cover
- V122-05** Ø 55 x 35 mm brass, without cover
- V122-06** Ø 70 x 45 mm brass, without cover
- V122-07** Ø 90 x 20 mm aluminum, with cover
- V122-08** Ø 55 x 40 mm aluminum, without cover
- V122-11** Ø 55 x 36 mm aluminum, without cover



V122...



V125-12...V125-18

## PLASTIC CONTAINERS WITH AIRTIGHT LID

Pack of 10 pieces

Model	Capacity	Handle	Quantity
V125-12	1 litres	no	10 pcs
V125-16	6.1 litres	yes	10 pcs
V125-18	12.5 litres	yes	10 pcs

## PANS aluminum, galvanized and stainless steel made

Model	Dimensions mm	Material
V182	600x600x80	galvanized steel
V182-03	500x400x120	galvanized steel
V182-04	250x120x80	galvanized steel
V182-06	306x306x38	galvanized steel
V182-07	460x460x50	galvanized steel
V182-08	910x910x76	galvanized steel
V182-01	370x260x50	aluminum
V182-02	330x220x50	aluminum
V182-05	270x180x50	aluminum
V182-10	265x195x47	stainless steel
V182-11	315x240x50	stainless steel
V182-12	370x270x57	stainless steel
V182-13	420x305x60	stainless steel

## SAMPLE CONTAINERS, TINNED STEEL, AIRTIGHT LID

Model	Capacity
V125	0.5 litre
V125-01	1 litre
V125-02	3 litres
V125-03	5 litres
V125-04	11 litres

V125...V125-04



V182...

V182-10...

V182-01...

## SCOOPS

### ROUND ALUMINIUM

Model	Dimensions mm	Capacity ml
V183	245x80	325
V184	260x90	500
V184-01	335x120	1000
V184-02	380x145	1550
V184-03	420x160	2600

### FLAT ALUMINIUM

Model	Dimensions mm	Capacity ml
V184-04	210x70	165
V184-05	310x110	450

### ROUND STAINLESS STEEL

Model	Dimensions mm	Capacity ml
V185	100x185	500 ml
V185-01	120x200	1000 ml
V185-02	150x270	2000 ml
V185-03	125x250	5 kg of concrete

STANDARDS: EN 12350-1 | UNI 9416  
BS 1881:101



## SPATULAS

### FLEXIBLE, STAINLESS STEEL

Model	Blade length mm
V192	100
V192-01	150
V192-02	200
V192-03	300

### RIGID, STAINLESS STEEL

Model	Blade width mm
V192-04	20
V192-05	50
V192-06	70
V192-07	100

**V192-08** CHATTAWAY SPATULA 120 mm long.



- A068-05** SCOOP steel made, 700x300x100 mm
- V186** SAMPLING SPOON, large sized
- V186-01** LADLE, stainless steel
- V187** RECTANGULAR TROWEL 120x260 mm stainless steel
- V188** TROWEL 100x200 mm - stainless steel
- V189** TROWEL 60x140 mm - stainless steel
- V193** STEEL HAMMER, 300 g
- V194** STEEL MALLET, 1000 g
- V194-01** STEEL MALLET, 2000 g
- V195** RUBBER MALLET, head Ø 55 mm
- V196** SHOVEL, with handle
- V197** PICK MATTOCK, with handle
- V198** DENSITY CHISEL, 300 mm long x 25 mm wide
- V199** DENSITY PICK, small sized
- S124** WIRE SAW
- S125** TRIMMING KNIFE

## HOT PLATES

Laboratory general utility hot plates, used to dry soil and aggregate samples, and for other general heating applications.

**Power supply:** 230V 1ph 50-60Hz

### AVAILABLE MODELS

#### ROUND PLATES

Cast iron plate, with temperature control by a multiposition thermostat.

**V200** PLATE DIAMETER 185 mm - 1500 W

**V200-02** PLATE DIAMETER 220 mm - 2000 W

#### RECTANGULAR AND SQUARE PLATES

- aluminium alloy plate
- max. temperature: 350 °C
- thermostat range 0-350 °C with fluid expansion probe
- insulation class: 1
- two fuses to ensure electrical protection
- bipolar main luminous switch
- pilot light to signal active status of the heating element

**V200-01N** RECTANGULAR PLATE 200x300 mm - 1500 W

**V200-03N** SQUARE HOT PLATE 380x380 mm - 2000 W

**V200-05N** RECTANGULAR PLATE 400x500 mm - 2000 W

**V200-06N** RECTANGULAR PLATE 400x600 mm - 2000 W

**B074****V200****V200-05****V200-01**

## HOT PLATES

(They can be used also for the determination of the softening point of bitumen, see p. 150)

**B074** ROUND PLATE Ø 160 mm - 1000 W

### B073-01

HOT PLATE WITH MAGNETIC STIRRER

Complete with thermoregulator for temperature adjustment and magnetic stirrer with electronic adjustment from 100 to 1200 rpm. Suitable for tests in distilled water with softening point between +30 °C to +80 °C.

**Power supply:** 230V 1ph 50-60Hz 700W

**Weight:** 4 kg approx.

**B073-01**

### B073-02

HOT PLATE WITH MAGNETIC STIRRER

Same to mod. B073-01, but with more powerful electric heating resistance, suitable **also** for tests in glycerine with softening point over +80 °C up to +150 °C.

### V203 VACUUM PUMP

Portable, one stage type, it produces an ultimate vacuum of 650 mm Hg (150 mbar)

Volume sucked: 2 Cu.m/h

Supplied complete with water trap and electric cable

**Power supply:** 230V 1ph 50 Hz

**Dimensions:** 180x180x220 mm

**Weight:** 5 kg approx.



### VACUUM PUMP

Lubrifed, paddle rotatory type.

Supplied complete with:

Thermal protection with automatic resetting, assembled inside the motor.

On/Off luminous switch, cable, carrying handle, base, bottle of special oil.

CE labelled with certificate of conformity.

Ideal for laboratory and site use to produce vacuum

Rotation speed: 2800 rpm

**Power supply:** 230V 1ph 50-60Hz

### V204 VACUUM PUMP

Portable, volume sucked: 5 Cu.m/h

Ultimate vacuum 730 mm/Hg (40 mbar)

Supplied complete with water trap and electric cable

**Power supply:** 230V 1ph 50Hz

**Dimensions:** 220x260x190 mm

**Weight:** 12 kg approx.



### AVAILABLE MODELS

Models		V205	V205-01	V205-02
Free air displacement	litres/min.	75	75	150
Ultimate vacuum	mbar	0.1	0.01	0.01
Stages		1	2	2
Motor power	W	180	240	370
Dimensions	mm	300x150x240	300x150x280	350x150x275
Weight	kg	8.4	9.8	11



### ACCESSORIES

**V205-10** VACUUM REGULATOR, complete with vacuum gauge Ø 80 mm, regulation cock, suction filter.

**V230-03** RUBBER TUBE, lined for vacuum, 3 m long

**V205-12** CONDENSED WATER TRAP

### SPARES

**V205-11** Special oil for vacuum pumps. Bottle of 500 cc.



### V202

ASPIRATOR PUMP, used with current water having approx. pressure of 0.7 kg/cm<sup>2</sup> to create a moderate vacuum.





**V201**
**WARM AIR DRIER**

For general laboratory purposes, to dry soil and aggregate samples.

**Power supply:** 230V 1ph 50Hz 1200W

**V201**
**V201-01**
**BUTANE THREE-BURNER**

field heater, to be used with a common butane cylinder.

Dimensions: 600x320x90 mm approx

Weight: 5 kg approx.

**V201-01**
**V208-05**
**UNINTERRUPTIBLE POWER SUPPLY**

Used to protect electrical devices from fluctuations in the power supply and to provide emergency power for a limited time

- Input voltage: 230V
- 50-60Hz 1ph
- Output voltage 230V

**Dimensions:** 150x240x360 mm

**Weight:** 16 kg approx.

**V208-05**
**V208-10**
**VOLTAGE STABILIZER**

It maintains the voltage stable, by adjusting and linearizing the tension variations.

Advantages: high quality of the tension, better load protection against electromagnetic disturbances.

Recommended when electronic, informatic, PC devices are used.

Power: 4 kVA

Accuracy:  $\pm 3\%$

**Nominal output voltage:**

18A 230V 1ph 50Hz

**Weight:** 25 kg approx.

**V208-10**
**S351N**
**LABORATORY AIR COMPRESSOR**

It reaches a maximum pressure of 15 bar and it is normally used with the air/water interface system (see p. 550).

Sucked air: 84 litre/minute.

Reservoir capacity: 3 litres.

**Power supply:** 230V 1ph 50Hz 0.75HP

**Dimensions:** 460x300x470 mm

**Weight:** 22 kg approx.

**S351N**
**V207**
**LABORATORY AIR COMPRESSOR**

Max. pressure: 10 bar

Air delivery: 240 litre/minute.

Reservoir capacity: 50 litres

**Power supply:** 230V 1ph 50Hz 1.5KW

**Weight:** 40 kg approx.

**V207**
**V206**
**AIR COMPRESSOR**

Max pressure: 8 bar

Air delivery: 222 litre/minute

Reservoir capacity: 24 litres

**Power supply:** 230V 1ph 50 Hz 1.5 KW

**Weight:** 30 kg approx.

**V206**
**V206-01**
**AIR COMPRESSOR**

Max pressure: 10 bar

Air delivery : 260 litre/minute

Air reservoir: 90 litres capacity

**V206-02**
**AIR COMPRESSOR**

Max pressure: 10 bar

Air delivery: 320 litres/minute

Air reservoir: 200 litres capacity

## WATER STILLS

Stainless steel manufactured, they are used to produce distilled water for laboratory purposes, they are equipped with an automatic device to keep the water at a constant level and to cut off the current in case of shortage of water, overheating.

**Power supply:** 230V 1ph 50-60Hz



V211

### AVAILABLE MODELS

#### V211

WATER STILL 4 LITRES/H CAPACITY

**Power:** 3000W

**Dimensions:** 250x222x542 mm.

**Weight:** 13 kg approx.

#### V211-01

WATER STILL 8 LITRES/H CAPACITY

**Power:** 6000W

**Dimensions:** 260x260x610 mm.

**Weight:** 16.5 kg approx.

## PH METERS, DIGITAL

STANDARDS: ASTM D1067 | BS 1377:3

### AVAILABLE MODELS

#### V215

pH METER, POCKET, battery operated, with replaceable electrode

Range: 0.00 to 14.00 pH - Resolution 0.01 pH  
Manual 2 points calibration.

Power supply: standard battery, 3000 hours use.  
Supplied complete with: electrode, batteries, 5+5 kit of pH 4 and 7 calibration solutions

**Weight:** 70 g



V215

#### V215-01N

### PH / MV / °C METER, PORTABLE, WATERPROOF

Range pH: 0.00 to 14.00 - Resolut. 0.01 pH

mV:  $\pm 1999$  - Resolut. 0.1mV - 1mV

Temperature: 0 to 100 °C

Manual 2 points calibration.

Automatic temperature compensation.

Power supply: 9V battery, 100 hours use.

Supplied complete with: electrode, temperature probe, battery, calibration solutions, case.

**Weight:** 180 g



V215-01N

#### V215-02N

### PH / °C ORP (OXIDATION REDUCTION POTENTIAL) METER LABORATORY MODEL

Range pH: -2.00 to 16.00 - Resolut. 0,01pH

Temperature: -20 to 120.0 °C - Resolut. 0.1 °C

Automatic 1 or 5 points calibration with 7 memorised buffers.

Automatic temperature compensation.

Digital electrodes with mini-jack connector.

Power supply: 5Vdc (230V adapter included)

Supplied complete with: electrode, temperature probe, electrode-holder, adaptor, calibration solutions, dual USB port

**Dimensions:** 202x140x13 mm

**Weight:** 250 g



V215-02N

### ACCESSORIES (for all pH models)

**V215-11** BUFFER SOLUTION, pH 4.01

**V215-12** BUFFER SOLUTION, pH 7.01

**V215-13** BUFFER SOLUTION, pH 10.1

**V215-14** ELECTRODES MAINTENANCE SOLUTION

**METAL STANDS**, with rod

**V219** Metal stand, base 165x140.  
Rod Ø 10x500 mm  
**Weight:** 3 kg approx.

**V219-01** Metal stand, base 200x260.  
Rod Ø. 12x800 mm  
**Weight:** 5 kg approx.



V219...



V220...

**V220** Hoffman screw clamp, max opening 25 mm

**V220-01** Mohr clamp

**V220-02** Double sleeve metal/metal. Ø 10...25 mm

**V220-03** Double sleeve metal/metal. Ø 10...20 mm

**V220-04** Simple clamp. Ø 10...20 mm

**V220-05** Simple clamp. Ø 20...30 mm

**V222  
TOOL KIT**

For general purpose uses and normal maintenance of laboratory equipment.

**Weight:** 7 kg approx.



V222

**LABORATORY TROLLEY**

Used for laboratory displacement of heavy pieces like moulds, soil and concrete samples etc.

Steel made, mounted on rubber wheels.

**V224** Trolley platform size 735x475 mm  
**Weight:** 9 kg approx.

**V224-01** Trolley platform size 910x610 mm  
**Weight:** 17 kg approx.

**V225** Trolley at double shelf size 790x480 mm  
**Weight:** 21 kg approx.



V225

V224

**V226  
WHEEL BARROW**, pneumatic type

V226

**RUBBER TUBING**

Model	Inside diameter	Length
V230	5 mm	5 metre
V230-01	6 mm	5 metre
V230-02	8 mm	5 metre

**V230-03  
SPECIAL TUBING FOR VACUUM**

Applications 8 mm inside diameter by 3 metre length.



V230...

## V241 SAND BATH

For the homogeneous heating or evaporation of the content of beakers flasks et.

**Inside dimensions:** 300x240x90 mm Volume: 7 litres

**Overall dimensions:** 420x400x280 mm

**Power supply:** 230V 1 ph 50/60 Hz

**Weight:** 17 kg approx.



V241



V218...

**FILTER PAPER**, pack of 100 pieces

Model	Whatman n° x Ø	Degree of filtration
V218-01	1 x 110 mm	Fast
V218-02	1 x 150 mm	Fast
S200-14	5 x 150 mm	Slow
V218-05	40 x 150 mm	Middle
V218-06	44 x 150 mm	Slow
V218-07	44 x 110 mm	Slow
V218-08	50 x 110 mm	Slow
V218-09	54 x 150 mm	Fast
V218-10	540 x 150 mm	Middle
V218-11	541 x 110 mm	Slow
V218-12	54 x 400 mm	Fast

## THERMOSTATIC WATER BATHS

See Sections: Asphalt/Bitumen p. 74

Cement/Mortars p. 382

Soils p. 458



B052

## CHEMICALS

Model	Description	Q.ty
V300-05	Distilled water	2000 ml
V300-15	Silica gel	1000 g
V300-16	Glycerine	1000 ml
S328	Vaseline oil	1000 ml
V300-19	Paraffin wax	5000 g
V300-23	Sodium hexametaphosphate	1000 g

Model	Description	Q.ty
V300-24	Sodium hydroxide	1000 g
V300-25	Sodium sulfate	1000 g
V300-28	Blue of methylene	100 g
V300-29	Kaolinite	500 g
V300-30	Ion exchange resin	500 g

**Note:** Several chemicals classified as dangerous, cannot be supplied for shipping safety problems.



V300...

# INDEX \_\_\_\_\_

**ANALYTICAL** **603 - 614**

---

**STANDARDS** **615 - 623**

---

**PRODUCT CODE** **624 - 638**

---

A	Mod.	Page
AAV - Aggregate abrasion value	A111N	59
Abrams, slump cone	C178 KIT	332
Abrasimeter	A109	63
Abrasimeter for natural stones and concrete	A112	59
Abrasion machine, Dorry	A111N	59
Abrasion machine, Los Angeles	A075N	46, 86
Abrasion tester Böhme	C129	324
Abrasion tester, Planetary	B053-20	136
Abrasive white corundum	A112-01	59
Abson, recovery of binder	B018-10	83
Absorption cone and tamper	S148	54, 136, 479
Accelerated curing of concrete	C307	347
Accelerated polishing machine	A128N	58, 168
Accessories for tests on metals	H001A-11	437
Accredia hardness certificate	C097-08	313
ACD - Automated Core Drill	B040-20	120
Acidity test kit of water	S135	469
Adhesion test Vialit apparatus	B053	136
Adhesion tester, plaster	E142	363, 406
Adhesive for tiles	C313-05N	27, 349
Admixtures for concrete	C199-10	337
Affinity between aggregate and bitumen	B022SP	52
AgeingVessel	B091M	158
Aggregate crushing value apparatus	A082	53
Aggregate density by water displacement	A086	53
Aggregate impact value apparatus	A080 KIT	47
Aggregate shape gauge	A072	45
Air/water permeability of concrete, Figg technique	C375-10 KIT	365
Air bath for bitumen	B016	141
Air compressors	S351N / V206	550, 598
Air content meters, cement	E027	386
Air content of mortar: measurer	E029	385
Air drier	V201	598
Air entrainment meters, concrete	C195	336
Air jet sieving machine	A058-05N	38, 51, 478
Air permeability apparatus, Blaine	E009 KIT	384
Air/water permeability of concrete	C375-10 KIT	365
Air/water pressure system, triaxial test	S350N	550
AMA - Asphalt Mix Analyzer	B003	76
AMPT/SPT Asphalt Mixture Performance Tester	B200	196
Analytical balance	V065-02	579
Andreasen pipette	S144	52, 475
Anemometer	V148-01	589
Angle measurer, Gyrotory	B041-28	105
Angularity of aggregates	A073N	45
Anvil for test hammers, concrete	C390	64, 368
APS - Automatic Pave Saw	B040	118
Aquameter, moisture meter	C374-06	364
ARC - Asphalt Roller Compactor	B039	106-109
Armoured thermometers	V162	591
Array meter , resistivity method	C412-01	375
ASC - Asphalt Shear box Compactor	B039A	110
Ash content	A022N	25, 79
Asphalt compactibility	B031N1 / B033N	94, 95

Asphalt content, furnace by ignition method	B005	79
Asphalt density	B111	165
Asphalt indentation penetrometer	B059-10	87
Asphalt Institute viscometers	B088-34	163
Asphalt Mix Analyzer - AMA	B003	76
Asphalt mixers	B027	91, 465
Asphalt Mixture Performance Tester	B200	196
Asphalt oven with rotating shelf	"B064 KIT"	149
Asphalt permeability	B024	164
Asphalt samples sealing device	B114 / B114-12	89
Asphalt samples vacuum drying device	B115	89
Asphalt shear box compactor	B039A	110
Aspirator pump	V202	479, 597
Assessment of fines aggregates: methylene set ..	S157 KIT	52, 475
Assessment of flatness	C250-10	339
Augers, hand and power head	S092 KIT / S097	462
Autoclave for soundness, cement	E070	396
Automated Core Drill - ACD	B040-20	120
Automatic binder extraction unit	B008	78
Automatic data acquisition and processing systems	S334	528, 559
Automatic Pave Saw - APS	B040	118
Automatic servo-controlled system for pressure setting	C104N LP	70
AutoRice	B067A	85
Autotec, automatic servo-controlled system two channels	C098N	219-221, 413
Axial strain measurement	S336-11	287, 303, 549

B	Mod.	Page
Bacon sampler	B060	142
Bags, plastic	V145-10	587
Balance mud Baroid	E037-01	388
Balance, electronic analytical	V065-02	579
Balance, moisture determination	V023-01	30, 473, 579
Balances, electronic	V070-02	581
Balances, Ohaus	V014	578
Balances, zero-centering	V031	578
Ball penetration measuring apparatus	E031	387
Balloon density apparatus	S230 KIT	523
Bar (grid) sieves	A048N KIT	32
Bar container, mortar	E067-05	62, 399
Barcode scanner	C099-01	223
Baroid mud balance	E037-01	388
Barton comb	A122	63
Basket, density	V041	54, 337, 582
Batching scales	V051	578
Bath air, bitumen	B016	141
Bath, cooling for resilience tests on steel	H052	453
Bath, Le Chatelier	E064N	398
Baths, bitumen	B052	135, 601
Baths, curing aggregates/cement	E136	54, 410, 479
Baths, Marshall	B051	134, 135
BBR - Bending Beam Rheometer	B085-05	157
Beaker EN 933-9	S157-05	52, 475, 587

Beakers, pyrex glass	V104	583
Beam apparatus, Benkelman	B100	166, 519
Beam device, travelling	B098N	165
Beam moulds, concrete	C254	342
Bearing capacity and deflection	B103-05 KIT	167
Bearing plate equipment, soil	S222D KIT	514
Bearing plate, road pavements	B103-10	167, 516
Bench for testing machines	C126	317
Bending beam Rheometer	B085-05	157
Bending machine, steel	H065N	454
Bending test on metal	H001A-40	437
Bending test, four points	S205-16	322, 506, 512
Benkelman beam apparatus	B100	166, 519
Binder adhesion, Vialit	B053	136
Binder drainage, basket method	B022-20	88
Binder recovery apparatus	B018	83
Binder, automatic extraction unit	B008	78
Bits, diamond for drilling machines	C339-01	120, 357
Bitumen emulsion: penetration power	B075-08	152
Bitumen emulsion: settling tendency	B075-01	152
Bitumen Ageing Vessel	B091M	158
Bituminous emulsions: mixing stability with cement residue on sieving	B076-21/B076-24	147
Blade, diamond	C350-12	358
Blaine air permeability apparatus	E009 KIT	384
Blaine automatic air permeability apparatus	E011-01	384
Blaine, electronic air permeability apparatus	E011N	384
Bleeding determination, concrete	C199-10	337
Blue of methylene	V300-28	52, 475, 601
Blue of methylene test set	S157 KIT	52, 475
Böhme, abrasion tester	C129	324
Bond strength tester, Pull-Off	E142	363, 406
Bottle dropping	V124	585
Bottle roller	B022SP	52
Bottle specific gravity	V108	479, 584
Bottle, Hubbard specific	V111	146, 585
Bottles, plastic	V118	587
Bouyancy balance system	V085	582
Bowls, mixing	V116	594
Boxes, plastic	V127	330, 587
Breaking point, Fraas apparatus	B077 KIT	146
Brickworks, test on	C358-01	360
Briquette mould, cement	E111	408
Bristles	V179	36, 593
British gypsum crystacal plaster	A129-04	67
Broaching machine, steel	H057N	453
BRTA viscometers	B084-01 KIT	153
Brushes	V178	593
Buchner funnel	V140	588
Bucket	V128	587
Bulk cement sampler	E020	385
Bulk density measures, aggregates	A069	31
Bulk density of bitumen	V085	582
Bulk density of cement	E025	385
Bulk density of lime	E091	387
Bunsen burner	V173-01	593

Burettes, graduated	V143	586
Burner, butane	V201-01	598

<b>C</b>	<b>Mod.</b>	<b>Page</b>
Cabinet with aspirator	B079N	81, 147
Cabinet with aspirator for binder extraction unit	B008-10	78
Cabinet, freeze and thaw	C313N	26, 348
Calcimeter, Dietrich-Frühling	A105	60, 400
Calibration anvil for concrete test hammers	C390	64, 368
Calibration device for Benkelman	B100-02	166
Calibration equipment for testing machines	C138N	146, 326, 448
Calibration glass beads	A060- 31/A060-50	44
Calibration process	C138-05, C155-05, S337-51..	146, 325, 503-513
Calibration unit for extensometers and dial gauges	S390	574
California bearing ratio - CBR	S200-01N	489, 490
Calipers, Vernier	V175	593
Calorimeter, heat of hydration	E061N	395
Canin, corrosion analysing equipment	C411N	375
Cannon BS-IP-RF viscometers	B088-80	163
Cannon-Fenske viscometers	B088-50	163
Cannon-Manning vacuum viscometers	B088-20	163
Capping compound	C290-06	351
Capping equipment of concrete, sulphur method ..	C290-01	351
Capping pads, concrete	C107-09	316, 350
Carbide moisture meters	A025 KIT	29
Carbonation test	C375-02N	364
Casagrande liquid limit	S170	480
CBR in situ apparatus	S220 KIT	492
CBR loading machine, hand operated, field model	S210 KIT	492
CBR testing machines	S209 KIT/S216 KIT	493, 495
CBR, moulding equipment.	S200-01N	489, 490
CBR/Marshall testers	S213-05N S214-05N KIT	124, 494
CBR/Proctor compactor	S199	486
CDAS - 8 and 16 channels	B205, B206	170
Cementometers	C214	338
Centrifuge extractor, bitumen	B011	80
Chapman flask	A029	30
Charpy pendulum impact tester	H060N	456
Charts, colour soil	S132N	60, 469
Chattaway, spatula	V192-08	385, 595
Chemical products	V300-05	601
Chisel	V194	523, 595
Chloride field test system	C375-02N	364
Chloride ion penetration meter	C378N	366
Chloride test kit of water	S136	469
Chloride titrator strips	A019-01	28, 472
Clamp, Mohr and Hoffman	V220 /V220-01	600
Classification of coarse recycled aggregate constituents	S156-20	52
Clay block portion, flexure test	C095-05	321





Deflection on fibre reinforced concrete	C090-07N	294
Deflectometer, telescopic	C405-10	377
Deflectometers, concrete	C405N	378
Deformometers, concrete	C360 KIT	359
Degrassing Oven, Vacuum	B091M-01	159
Demoulding oil	C265	343
Density baskets	V041	54, 337, 582
Density chisel	V198	523, 595
Density gauge, asphalt	B111	165
Density of fresh concrete	C199	337
Density of hardened concrete	V085	582
Density of soil in place	S230 KIT/S237 KIT	523, 525
Density pick	V199	523, 595
Desiccators	A035	30, 479, 586
Deval testing machine	A079	47
Device with central screw	C105	313
Dewar flask.	E062-01	395
Dial indicators and holder	S375	287, 362, 574
Diamond bits for drilling machines	C339-01	120, 357
Diamond blades for cutting machines	C350-12	358
Dibber tool	S240-02	523
Die cutting soil sampler	S118	471
Dietrich-Fruhling calcimeter	A105	60, 400
Differential mercury manometer	S356N	552
Digital shear machine for soil	S276-02N	540
Digitec, two channels semi-automatic control unit ..	C108N	219-221, 413
Direct shear, Leutner	B047-10	123, 127, 131
Direct tension tester, DTT	B225-09	211
Direct/residual shear machines	S276 KIT / S276-01	537
Dish, Petri	V123	585
Dishes, evaporating	V114-01	588
Displacement transducers	S336-11	549
Distance pieces for compression machines	C111	320
Distillation of cut-back asphalts	B069 KIT	147
Distilled water	V300-05	601
Distribution unit water/air for triaxial test	S348	551
Door safety switch	C121-51	317
Dorry, abrasion machine	A111N	59
Drainage basket, binder	B022-20	88
Drainage burette, triaxial	S321	546
Drier, warm air	V201	598
Drill bits	C339-01	120, 357
Drilling machines, asphalt cores	B040-20	120
Drilling machines, concrete	C318N	355
Drilling muds, sand content	E037-10	388
Dropping ball apparatus, cement	E031	387
Dropping bottle	V124	585
Drop-weight tester	S228N	521
Dry-ice maker, metals	H050	453
Drying ovens	A005-01 KIT	22
Drying shrinkage determination	A107	62
DSR - Dynamic Shear Rheometer	B085-07N	157
DTS-130, 130 kN Servo-Hydraulic Dynamic Testing System	B240	178
DTS-16, 16 kN Servo Pneumatic Dynamic Testing Systems	B220-01 KIT	174

DTS-30, 30 kN Servo-Hydraulic Dynamic Testing System	B230	176
Dual low capacity range	C097-01	313
Ductility of fibre reinforced, concrete	C090-16	303, 305
Ductilometers	B054	144, 145
Ductilometers with data acquisition system	B055-10/B055-20N	145
Duriez test set	B095-01	131, 511
Dynamic cone penetrometer (DCP)	S051	460
Dynamic plate load test	S228N	521
Dynamic shear Rheometer	B085-07N	157
Dynamic Test Configurations	/	182-192
Dynamic Testing System, 130 kN Servo-Hydraulic	B240	178
Dynamic Testing System, 30 kN Servo-Hydraulic	B230	176
Dynamic Testing Systems, 16 kN Servo-Pneumatic	B220-01 KIT	174
Dynamic viscosity viscometer	B085-21	160
Dynamometers, Pull-Off bond strength	E142	363, 406

<b>E</b>	<b>Mod.</b>	<b>Page</b>
Earth resistivity meter	S077	468
Edotronic, automatic oedometer	S262N	533
Efflux index apparatus	A073N	45
Efflux viscometers	B084-01 KIT	153
Elastic modulus on concrete	C125N	284
Elastic modulus on mortar	E190N	430
Elastic modulus on rocks	A150N	68, 69, 70
Elasticity modulus on concrete, compressometers ..	C130N	287
Electric generator, portable	C332	355
Electro-Hydraulic loading and control system	C109-09N	289, 307
Electromagnetic density gauge, non nuclear	B111	165
Electromagnetic sieve shakers	A059-01 KIT	40
Electromagnetic vibro-deaerator	A059-02 KIT	84
Electromechanical overlay tester	B215EM	210
Electronic precision top loading and platform balances	V070-02	581
Electro-welded wire nets test, accessory	H003-14	441
Elongation index of aggregates	A071	45
Emery corn and flour	A128-02	58
Emulsified asphalt distillation apparatus	B063 KIT	143
End-Over-End shaker, BS 1377:2	A117	60, 473, 475
Energy absorption test on sprayed concrete specimens	C090-07N	294
Engler viscometers	B080	153
Equivalent test, sand	S158-20 KIT	50, 476
Erlenmeyer flasks	V106	583
Evaporating dishes, porcelain	V114-01	588
Evaporation, rotary apparatus	B065	84, 152
Expansion of concrete or mortar	E114	362
Explosion proof centrifuge	B011-01	80
Extensibility of mould apparatus	E066-03	398, 399
Extensometer wire strands	H003-18	445
Extensometer, electronic for metals	H014	439, 445, 448

Extensometer, plaster	E080	400
Extensometer/Compressometer, concrete, cement	C134	286, 431
Extensometers single use, concrete	C125-10	69, 285, 431
Extraction of binder, automatic	B008	78
Extraction of binder, centrifuge	B014	81
Extraction of bitumen	B016-10	82
Extruder for rocks	A141	71
Extruder, Marshall-CBR-Proctor specimens	S114	97, 470
Extruders, soil	S111 / S114	470

<b>F</b>	<b>Mod.</b>	<b>Page</b>
Falling head permeameter, soil	S246-01	526
Feeler strips	C250-12	339
Fibre reinforced concrete tests	C090-15	303, 305
Field CBR apparatus	S220 KIT	492
Field density	S230 KIT	523
Figg technique, air and water permeability of concrete	C375-10 KIT	365
Filler compaction apparatus	A124	53
Filter discs for centrifuge	B010-15	80
Filter flasks, glass	V107	584
Filter funnel	V138	586
Filter paper	V218-01	601
Filter press for muds	E037-05	388
Filterless centrifuge	B014	81
Filtration behaviour of drilling muds	E037-05	388
Fineness of cement, Blaine apparatus	E009 KIT	384
Fineness of fly ash by wet sieving	E017	385
First crack strength, concrete	C090-16	303, 305
Flakiness index grids	A048N KIT	32
Flakiness sieves BS 812	A049 KIT	32
Flakiness/thickness gauge	A070	45
Flash and fire tester, Cleveland	B086 KIT	154
Flash point, TAG viscometer	B092 KIT	155
Flask, Chapman	A029	30
Flasks, Erlenmeyer	V106	583
Flasks, glassware	V106/V109-09	583, 584
Flat jack method	C358-01	360
Flexural and transverse machine, concrete	C095N / C093-02N	296, 308
Flexural device with centre point	S205-18	321, 507, 512
Flexural device, concrete	C106	315
Flexural device, tests on clay blocks	C093-11	293-299, 309
Flexural devices, cement	E172-01	428
Flexural test, tiles and clay blocks	C095	323
Flexural testing machines, concrete	C090/C091-03N	288-309
Flexural testing machines, concrete high stiffness	C090-06N / C096N	294, 300
Flexural tests on clay block portion	C095-05	321
Flexural/compression machines, cement	E152 / E183N	422-426
Flexure test on concrete beams, accessory	C095N-11 H001A-40	297, 437
Flexure test on metals, accessory	H001A-40	437
Flooding system, internal	C313-05N	27, 349
Flour Emery	A128-03	58
Flow cone apparatus, cement	E038	388
Flow meter, Marshall	B047	121, 124, 494

Flow table, concrete	C192 KIT	333
Flow tables, cement	E086 KIT E090-01 KIT	401
Flow tables, concrete	C208	338
Flow test apparatus, grouts	E059	394
Flow time determination	C171	330
Flowing water sieves device, cement	E016	385
Fly ash fineness by wet sieving	E017	385
Footmeter stability verification tester	C155N	325
Four Point Bending System - Jig	B210-01	193
Four Point Bending System - Stand-Alone	B210 KIT	193
Four point bending test	S205-16	322, 506, 512
Four Point Jig	B212	184, 194
Fraass apparatus	B077 KIT	146
Free expansion in plastic period, cement	E060	394
Free flow and time flow of concrete	C181	330, 332, 333
Freeze and thaw chambers	C313N	26, 348
Fresh concrete testing	C178 KIT	332
Friction tester (Skid)	A113	56, 168, 324
Front loading oedometer	S260	528
Fume exhaust cupboard	B079N	81, 147
Funnel groove, UNI 8997	E059	394
Funnel viscometer Marsh, cement	E037	388
Funnel, Buchner	V140	588
Funnels, glass	V119	585
Funnels, plastic	V135	587
Furnace, ignition method for asphalt	B005	79

<b>G</b>	<b>Mod.</b>	<b>Page</b>
GAM - Gyrotory Angle Measurer	B041-28	105
Gas jar	A116-11	60, 473
Gasometer, Dietrich-Frühling	A105	60, 400
Gauge crack width	C408	378
Gauge dial indicators	S375	287, 362, 574
Gauge for aggregate flatness index	A048-15	32
Gauge go-not go	C250-16	339
Gauges for compression machines	C118-03	317
Gauges, flakiness, length, shape	A070	45
Gauze, iron wire	V173-03	82, 83, 593
Gay-Lussac bottles	V108	479, 584
Generator, electric	C332	355
Geogauge, non nuclear density	S059	467
Geological hammers	A132	63
Geometrical properties of aggregates	S156-20	52
Gillmore apparatus	E058	389
Glass microspheres	A057-31/A057-46	44
Glassware	V098	583
Gloves, heat resistant	V177	593
Glycerine	V300-16	601
Go-not go gauge	C250-16	339
Granulator, asphalt	B007	85
Grid (bar) sieves	A048N KIT	32
Grinder - Polisher	A095	64
Grinding machine, concrete, rocks, natural stones	C298	65
Grooving tools	S173-03	480
Group combined frames	C092	310
Grouts tests	E036 KIT	387

Guards, safety for compression machines	C121	317
Gypsum tests	E055N	389
Gyratory compactor, asphalt	B041	98-104
Gyrotronic compactor, asphalt	B041	98-104

H	Mod.	Page
Hamburg Smartracker	B038A	114-117
Hammer digital, test on concrete	C386N	369
Hammer, geological	A132	63
Hammer, rocks classification	C381	64, 368
Hammers, steel and rubber	V193	523, 595
Hammers, test on concrete	C380	368
Hardness test kit of water	S137	469
Heat of hydration calorimeter	E061N	395
Heater isomantle, asphalt	B028-01	90
Heater, immersion asphalt	B051-01	134
Heater, immersion concrete	C302-01	346
Heater, immersion soil	S155-09	474, 475
Hoek cells, rocks	A136	71
Hoffman screw clamp	V220	600
Hollow punches and tampers, direct/ residual shear	S122-08	471, 538
Hollow punches and tampers, soil	S122	471, 529
Hopper, feed, cement	E106	408
Hot extraction apparatus, bitumen	B017 KIT	82
Hot extractor set	B016-10	82
Hot plates	B074, V200	150, 596
Hubbard-Carmik bottles	V111	146, 585
Humidity and temperature: cabinet	C313N	26, 348
Humidity and temperature: control panel	C309-10	347
Hydration calorimeter, cement	E061N	395
Hydraulic constant isotropic cell pressure system	A142N	72
Hydraulic shrinkage of concrete	C365	362
Hydraulic shrinkage of cement	E077 KIT	397
Hydrometer jar	S155-01	474
Hydrometers, soil	V172	474, 592
Hygrometer, hair	V169	589

I	Mod.	Page
Ignition method, furnace for asphalt	B005	79
Immersion vibrators	C272	345
Impact compactors, Marshall	B031N1 / B033N	94, 95
Impact failure test on tiles	C096	323
Impact pendulum tester, metals	H060N	456
Impact soil tester	S196N	490
Impact testing machine, aggregates	A080 KIT	47
Impermeability tester, concrete	C435	380
Impurities test bottle	S132-01	60, 86, 469
In situ CBR test set	S220 KIT	492
Indentation test on asphalt	B059-10	87
Index of velocity of rocks	C372M	372
Indirect tensile, bitumen	B047-02	121, 123, 131
Indirect tensile, concrete	C100	314
Infrared thermometer	C216	338
Inverter device	C099N	223
Ion exchange device	S140	472
Ion exchange resin	V300-30	472, 601

IP thermometers	B057-08	139, 140, 591
Isomantle heater	B028-01	90
Isotropic rocks pressure system	A142N	72

J	Mod.	Page
Jacks, flat for tests on brickworks	C358-01	360
Jar mill	A091-10	55
Jaws crusher	A092	55
Jig core face preparation	C300-08	65, 353
John Figg method	C375-10 KIT	365
Joisel apparatus	C211	335
Jolting apparatus, cement	E130	409
J-Ring, confined flowability	C174N	331

K	Mod.	Page
Kaolinite	V300-29	52, 475, 601
Kelly ball apparatus	C186	334
Kerbs and slabs device	C091-13	293, 315
Knife, trimming	S125	471, 595
K-slump tester	C187	334
K-type thermometers	C216	338
Kumagawa (Soxhelet) extractor	B061 KIT	82

L	Mod.	Page
Ladle	V186-01	351, 595
Langavant calorimeter	E062-10	395
Lathe, soil	S120	471
Le Chatelier flask	E014	385
Le Chatelier, mould	E066	398, 399
Le Chatelier, water bath	E064N	398
Length comparator, cement	E077 KIT	397
Length gauge, aggregates	A071	45
Leutner direct shear, bitumen	B047-10	123, 127, 131
Light drop-weight tester	S228N	521
Lightweight dynamic penetrometer	S050	460
Lime testing	E034/E064N	386, 398
Lime testing reactivity apparatus	E034	386
Limits of solis	S165 KIT/S166 KIT	482
Linear displacement transducers	S336-11	549
Linear shrinkage mould, soil	S176	481
Linear shrinkage of specimens, mortar	E077 KIT	397
Liquid limit devices, plastic limit	S170 / S178	480, 481
Load calibration apparatus	C138N	146, 326, 448
Load cells, standard	C140	327
Load frames, Marshall	B042 KIT	121, 498
Load proving rings	S370-01/S370-01S	548, 573
Los Angeles abrasion machine	A075N	46, 86
Loss of ignition of cement	A024N	25, 394
Loss on heating oven, asphalt	B064 KIT	149
L-Shape box test, confined flowability	C172	330

M	Mod.	Page
Machine for static tensile test on steel	H001A	434-439
Machine, Los Angeles	A075N	46, 86
Machines for compression tests, cement	E151 / E161-02N	418, 419
Machines for compression tests, concrete	C020	230
Machines for flexure tests, concrete	C090/C091-03A	290
Machines servo-controlled, steel	H004N / H008N	442-449

Mackintosh prospecting kit.	S051-01	461
Macrotexture depth, Sand patch	B099-10	164
Magnesium sulphate test	A103	61, 582
Magnetic holder for dial gauges	S380	574
Magnetic stirrer	B073-01	150, 472, 596
Mallet, rubber	V195	343, 523, 595
Mallets, steel	V194	523, 595
Manometers for compression machines	C118-03	317
Marking pencil	V147-01	586
Marking-off machine, metals	H020	453
Marsh funnel viscometer cement	E037	388
Marshall load frames	B042 KIT	121, 498
Marshall moulding equipment	B029N KIT	94
Marshall, automatic compactors	B031N1 / B033N	94, 95
Marshall, manual compactors	B032 KIT / B032-01	95, 96
Marshall, water baths	B051	134, 135
Masses, standard calibration	V035-01	579
Max. min thermometer	V163	591
Maximum specific gravity of asphalt	B067N	84
Measurers, unit weight, concrete	C199, C200	337
Measuring graduated cylinders	V098	583
Measuring tester digital, concrete	C138N, C155N	146, 325, 448
Mechanical strain gauges, concrete	C360 KIT	359
Melting pot	A106	28, 88, 351, 464
Metal detectors	C396N	394
Methylene blue test	S157 KIT, S157-20	52, 475
Micro-coring equipment	C377	66, 354
Micro-Deval machine	A077	48
Microlance moisture-temperature tester	A021	30
Microscope, crack detection	C399	359
Microspheres, glass	A057-31 / A057-46	44
Microwave oven	A009	28
Mill jar	A091-10	55
Mineral filler method	B090	142
Miscellaneous	V	577-601
Mixer, dry	A093	55
Mixers, asphalt/bitumen	B027	91, 465
Mixers, concrete	C164	328
Mixers, mortar	E092N KIT / E095	402, 405
Mixers, soil	E095	90, 405
Mixing bowls	V116	594
Modified Proctor test	S185	484
Modulus of elasticity, mortars	E190N	430
Mohr clamp	V220-01	600
Mohr, pipettes	V142	586
Mohs stone hardness kit	A115	63
Moist curing room	C309-10	347
Moisture balance	V023-01	30, 473, 579
Moisture condition value (MCV)	S088-10	465
Moisture density (Proctor test)	S185 / S187	484, 485
Moisture density gauge, nuclear	S058	466
Moisture induced stress tester	B068	89
Moisture meter, Aquameter	C374-06	364
Moisture meter, Microlance	A021	30
Moisture meter, microwave	A021-10N	30
Moisture meter, Surveymaster	C374	364
Moisture testers, aggregates/soil	A028	29, 364, 473

Mortar and pestle, porcelain	V112	588
Mortar and pestle, stainless steel	V112-05	594
Mortar bar container	E067-05	62, 399
MOT straight edge	B099 KIT	166
Mould Le Chatelier	E066	398, 399
Mould, craking test	E067	400
Mould, Duriez test	B095-01	131, 511
Mould, P.R.D.	B097	97
Moulds CBR	S200-01N	489, 490
Moulds ductility	B054-01	144
Moulds Marshall, ASTM Spec.	B030 KIT	97
Moulds Marshall, EN Spec.	B029N KIT	94
Moulds Proctor	S185	484
Moulds, cement, prisms	E102 / E112	408
Moulds, cement, shrinkage and expansion tests	E072/E113	396, 397
Moulds, concrete	C223	340
Moulds, gyratory compactor	B041-05	103
Moulds, soil	S195-01	491
Mud Baroid balance	E037-01	388
Muds tests	E038	388
Muffle furnaces	A022N	25, 79
Multispeed testers	S212N/S216 KIT	124, 494-496
Multi-tester 200 kN	S206N	130, 322, 508-513
Multi-tester 50 kN	S205N	126, 321, 500-507

<b>N</b>	<b>Mod.</b>	<b>Page</b>
NDT concrete	C380	368
Needle vibrators poker, concrete	C272	345
Neoprene gloves	V177-01	593
Neoprene pads	C107-18	350
Noise cabinet for sieve shakers	A058	41
Nuclear gauge verification and calibration device	S058-11	466
Nuclear moisture density gauge	S058	466

<b>O</b>	<b>Mod.</b>	<b>Page</b>
Oedometer	S260	528
Oedometer, automatic	S262N	533
Official Accredia hardness certificate	C097-08	313
Ohaus, balances	V014	578
Oil hydraulic for compression machines	C114-10N	318
Oil, demoulding moulds	C265	343
Oil/water pressure system	A144	72, 550
Organic matter test set	S138	469
Oven, loss on heating TFOT method	B064 KIT	149
Oven, rolling thin-film	B066M KIT	148
Ovens, laboratory	A005-01 KIT	22
Overlay Tester	B215	200

<b>P</b>	<b>Mod.</b>	<b>Page</b>
Pachometers (cover meters)	C396N	374
Packaged cement tube sampler	E021	385
Packing set for compression machines	C122	319
Packing strips, hard wood made	C100-01	314, 512
Pads, neoprene	C107-18	350

Pan type mixers	C164	328	Planetary abrasion tester	B053-20	136
Pans, metallic	V182	343, 594	Plaster adhesion tester	E142	363, 406
Paraffin wax	V300-19	28, 88, 395, 601	Plaster extensometer	E080	400
Particle charge tester	B063-10	143	Plastic cube, cylinder and beam moulds	C223	340
Particle density and water absorption	V085	582	Plastic limit set, soil	S178	481
Particle density of filler	V108-01	54, 479, 584	Plastic products	V102-01	587
Particle loss, asphalt	A075N	46, 86	Plasticity meter, concrete	C190	334
Particle shape of aggregates	A048N KIT	32	Plate bearing test, bitumen	B103-05 KIT	167
Particle size analysis of soils	S155 KIT	474	Plate bearing test, soil	S222D KIT	514
Particle size sedimentation/distribution	S143KIT/S155KIT	474, 475	Platens for compression machines	C110	320
Pat test	E082	398	Plates, hot	B074, V200	150, 596
PAV, Pressure Ageing Vessel	B091M	158	Platform balances	V070-02	581
Pavement core drilling machines	C319	356	Platinum crucible	V117-04	588
Pavement surface, irregularity measurement	B099 KIT	166	Plunger	S156-20	52
PaveMix, bitumen mixer	B026N	92	Plunger penetration apparatus, cement	E083	400
Pavetest Products	B200 / B293-02	169-212	Pocket penetrometers and shear vanes	S065 / S076-01	464
PaveTracker, wheel tracking	B038	112	Pocket penetrometers for concrete	C194	335
Pencil, marking	V147-01	586	Point load tester	A125N	64, 323
Pendulum impact resilience tester, metals	H060N	456	Poker vibrators	C272	345
Pendulum SkidTester	A113	56, 168, 324	Polarity of bitumen emulsion	B063-10	143
Penetration depth of water	C435	380	Polished stone value	A128N	58, 168
Penetrometer Proctor	S088	465	Polisher - Grinder	A095	64
Penetrometer proving ring, soil	S086	465	Polishing machine accelerated	A128N	58, 168
Penetrometer, asphalt indentation	B059-10	87	Polishing/Grinding machine, concrete	C298	65
Penetrometer, bitumen	B059M	138	Polystyrene cube mould, concrete	C231N1	341
Penetrometer, concrete	C213	335	Porcelain products	V112	588
Penetrometer, consistency of cement	E083	400	Pore pressure measurement	S353	552
Penetrometer, dynamic cone (DCP)	S051	460	Porosimeters, concrete	C195	336
Penetrometer, Kelly ball	C186	334	Portable rock shear box assembly	A129	67
Penetrometer, lightweight	S050	460	Pot for melting wax	A106	28, 88, 351, 464
Penetrometers, bitumen	B056 KIT / B057M	138	Potential alkali reactivity in concrete	A101N	62
Penetrometers, liquid limit soil	S165 KIT / S166 KIT	482	Potential alkali reactivity of cement-aggregate, container	E067-05	62, 399
Penetrometers, pocket for concrete	C194	335	Potential reactivity of aggregates, container	A030	30
Penetrometers, pocket soil	S065 / S071	464	Potentiometric transducers	S336-11	549
Pensky-Martens tester	B094 KIT	155	PRD mould	B097	97
Percentage refusal, P.R.D.	B097	97	Pressure Ageing Vessel	B091M	158
Permeability air, Blaine apparatus	E009 KIT	384	Pressure control panel	S342-01 / S342-02	551
Permeability apparatus, Blaine automatic	E011-01	384	Pressure maintainer	A129-02	67, 72
Permeability apparatus, Blaine electronic	E011N	384	Pressure measuring units, triaxial	S340	551
Permeability apparatus, concrete	C430	379	Pressure transducers	C116-01N	318
Permeability attachment for oedometers	S275	72, 529	Pressure transducers, pore	S336-50	552
Permeability of rocks	A144	72, 550	Pressurematic PVC	S349	563, 565, 569
Permeability set, air and water	C375-10 KIT	365	Printer, laser, bench	C128	313
Permeameter for bitumen pavements	B024	164	Prism moulds, cement	E102 / E112	408
Permeameter stand, soil	S248	527	Prism moulds, concrete	C254	342
Permeameter, radial-flow falling head	B024-10	164	Probe, Windsor	C410	376
Permeameters, soil	S246-01 / S253	526	Proctor penetrometer	S088	465
Personal computer for testing machines	H009-01	313	Proctor test: moisture/density	S185 / S187	484, 485
Pestle, rubber heated	V113	471, 588	Proctor/CBR compactor	S199	486
Petri dish	V123	585	Profilometers (Barton comb)	A122	63
PH metres	V215	472, 599	Profometers, metal detector	C396N	374
Pick	V197	595	Profoscope	C403-01	374
Pinhole test equipment	S244	525	Prospecting kit, soil	S052 KIT	461
Pipe testing machine	C093-05N	289, 307	Proving rings, load	S370-01/S370	548, 573
Pipette, Andreasen	S144	52, 475	Pull-Off, bond strength tester	E142	363, 406
Pipettes, graduated	V142	586			

Pull-Out tester	C376N	363
Pulse velocity tester, ultrasonic	C369N	63, 371
Pumping units	C113 / C114	318
Punching test on clay blocks	C093-11	321, 322, 506, 513
Punching test on sprayed concrete	C109-15N	282, 283, 298, 303
Pyknometer, 10 litres vacuum, bitumen	B067N	84
Pyknometer, soil	S147	54, 479
Pyknometers, pyrex glass	V105	583

Q	Mod.	Page
Quantab, chloride strips	A019-01	28, 472
Quarterming canvas	A085	53
Quick triaxial test, Unitronic	S205N	126-129, 321, 416, 500-507

R	Mod.	Page
Radial-Flow permeameter, bitumen	B024-10	164
Rain gauges	V167	589
Rammers, soil compaction	S187	485
Rate indicator, CBR	S210-02	493
Rate of spread device	B053-05	136
Reaction container	A030	30
Reactivity apparatus, lime EN 459-2	E034	386
Reagent bottles	V108-10	584
Reagent for moisture testers	A028-11	29, 473
Reagent products	V300-05	601
Rebar corrosion meters	C411N	375
Rebar detector and cover meter, concrete	C403-01	374
Rebound concrete hammers	C380	368
Recovery of binder	B018	83
Recovery solvent, still	B021	81
Redwood, viscometers	B084-01 KIT	153
Reference cement	E010-02	384
Reflux extractor	B019 KIT	83
Refrigerator, water	E141	347, 411
Refusal percentage density test	B097	97
Relative density cohesionless, soil	S238N KIT	522
Relative density of aggregates	S147	54, 479
Residue on sieving, bituminous emulsions	B076-21	147
Resilience test, pendulum impact tester for steel	H060N	456
Resistance of hardening, bituminous binders	B065	84, 152
Resistance to fragmentation, aggregates	A075N	46, 86
Resistance to freezing and thawing determination, aggregates	A103-10	61
Resistance to fuel	A075N	46, 86
Resistance to thermal shock	A023-01N	25, 63
Resistance to wear, aggregates	A077	48
Resistance, friction skid tester	A113	56, 168, 324
Resistivity method, array meter for concrete	C412-01	375
Resistivity of soils	S077	468
Resonance frequency meter	C393	370
Restrained expansion, mortar, concrete	E114	362

Retainers, capping, concrete	C107-09	316, 350
Retention water apparatus, cement	E039-01	387
Rheometer, bending and shear	B085-07N	157
Rice-Test	B067N	84
Rice-Test, Automatic	B067A	85
Riffle Boxes	A062	31
Ring and Ball apparatus	B072	150
Ring and Ball apparatus, automatic	B070N1	151
Ring load measuring	S370-01/S370-01S	548, 573
Road surface irregularity	B098N	165
Rock and masonry saw	C348T	358
Rock classification hammer	C381	64, 368
Rock compression device	A147	71
Rock cradle	A121	64
Rock elastic modulus	A150N	68, 69, 70
Rock index of velocity	C372M	372
Rock shear box apparatus	A129	67
Rock strength index	A125N	64, 323
Rock triaxial Hoek cells	A136	71
Roller Compactor, asphalt	B039	106-109
Roller, bottle	B022	52
Rolling Thin-Film oven	B066M KIT	148
Rotary automatic scales	V057	578
Rotary evaporation apparatus	B065	84, 152
Rotational viscometers	B085-21	160
RTFOT method, oven	B066N KIT	148
Rubber heated pestle	V113	471, 588
Rules	V176-01	332, 333, 593
Rules, folding	V176	593

S	Mod.	Page
Safety guards, concrete	C121	317
Sample containers, airtight lid	V125	594
Sample splitters, aggregates	A062, A068	31
Sampler, Bacon	B060	142
Sampler, die cutting	S118	471
Sampler, surface soil	S084 KIT	463
Samplers for soil	S053, S084 KIT	461, 463
Samplers, bulk and packaged cement	E020	385
Sampling of soil	S052 KIT	461
Sand absorption cone and tamper	S148	54, 136, 479
Sand bath	V241	601
Sand content of drilling muds	E037-10	388
Sand density cone apparatus	S234 KIT / S237 KIT	524, 525
Sand equivalent shakers, motorized	S160N	51, 478
Sand equivalent test set	S158 KIT	50, 476
Sand for density test, soil	S235	524
Sand for mortar mixers	E097-01N	405
Sand patch equipment	B099-10	164
Sand replacement apparatus	S236 KIT	525
Saw, asphalt automatic	B040	118
Saw, concrete specimens	C350T	358
Saw, rock and masonry	C348T	358
Saw, wire for trimming soil specimens	S124	471, 595
Saybolt, viscometers	B087	154
Scales	V057	578
SCC self compacting concrete	C171	330
Schmidt test hammers	C382	368

Scoop stainless steel, EN 12350/1	V185-03	333, 595	Softening point apparatus Wilhelmi	B072-20	143
Scoops, aluminium models	V183 / V184	332, 523, 595	Softening point, bitumen	B072	150
Scoops, stainless steel models	V185	595	Softmatic	B070N1	151
Scraper	S240-01	523	Software CBR test	S218N	18, 499, 503
Scratch hardness test	A087	47	Software elastic modulus on concrete	C125N	284
Screw pump, triaxial	S345	551	Software elastic modulus on mortar	E190N	430
Seismograph	S079	468	Software elastic modulus on rocks	A150N	68, 69, 70
Semi-Circular Bend System	S205N	126-129, 321, 416, 500-507	Software for servostrain	C109-10N	259, 281, 448
Servo-Plus Evolution, automatic control	C104N	224-228	Software for tensile test on steel	H009N	449
Servo-Strain, load/displacement/strain	C104-10N	282, 283	Software for unconfined test, soil	S218-01N	133, 499, 503
Setting time and consistency of cement	E055N / E044N	389, 390	Software OedoLab connect	S262-12N	533-535
Setting time of concrete	C213	335	Software OedoLab report	S260-05N	528, 531
Settling and swelling ratio, mortar	E036 KIT	387	Software ShearLab connect	S277-41N	541, 542
Settling of bitumen emulsions	B075-01	152	Software ShearLab report	S277-40N	537, 539
Shaker for sieves, high capacity	A061N	42, 43	Software TestLab	/	170
Shaker, End-Over-End	A117	60, 473, 475	Software TriaxLab connect & reports	S335-10N	544, 554
Shakers for sieves, electromagnetic	A059-01 KIT	40	Software UTM2	A150N / S224-21N	18
Shakers, sand equivalent	S160N	51, 478	Soil colour chart	S133N	469
Shape gauge, aggregates	A072	45	Soil hydrometers	V172	474, 592
Shear apparatus direct/residual, soil	S276 KIT/S276-02N	536, 540	Soil prospecting kit	S052 KIT	461
Shear box assembly, rocks	A129	67	Soil samplers	S053, S084 KIT	461, 463
Shear box compactor, asphalt	B039A	110	Soil: moulds	S195-01	491
Shear boxes	S282	538	Solubility of bituminous binders	B075-05	152
Shear rheometer, bitumen	B085-07N	157	Solution for sand equivalent test	S158-09	50, 476, 477
Shear vane devices, pocket for soil	S057 / S075	460, 464	Solvent recovery still	B021	81
Shearlab	S276 KIT	536	Soundness of building lime	E081-10	399
Sheartronic, high performance	S276-02N	540	Soundness of cement: autoclave	E070	396
Shovel	V196	595	Soundness of hydrated lime	E082	398
Shrinkage limit set and mould BS, soil	S175, S176	481	Soundness: Le Chatelier	E066	398, 399
Shrinkage of cement/mortar	E075	396	Soxhelet, extractor	B061 KIT	82
Shrinkage of concrete	C365	362	Soxhelet, extractor modified method	B016-20 KIT	82
Sieve conical EN 15366	B024-05	164	Spacer discs	S200-03	489
Sieve flakiness	A049 KIT	32	Spatulas	V192	481, 595
Sieve grids (bar), flakiness	A048N KIT	32	Specific gravity frame	V085	582
Sieve shaker, high capacity	A061N	42, 43	Specific gravity Gay-Lussac bottles	V108	479, 584
Sieve shakers	A060-01	44	Specific gravity, cement	E014	385
Sieve trays 457x660 mm	A061-07	43	Speedy moisture testers	A025 KIT	29
Siever, air jet	A058-05N	38, 51, 478	Splitter, asphalt	B007	85
Sieves	A052-....	33, 34	Splitters for aggregates, sand	A062	31
Sieves, wet washing	A045	36	Splitting tensile test devices, concrete	C100	314
Silica evaporating dish	V114-10	79, 588	Splitting tensile test, asphalt	B047-02	121, 123, 127, 131, 511
Silica gel	V300-15	30, 479, 601	Splitting tensile test, rock	S205N	126-129, 321, 416, 500-507
Siphon can apparatus	A084	53	Spoon	V186	523, 595
Skid tester	A113	56, 168, 324	Sprayed concrete, test on	C090-14	295, 306
Slabs and kerbs device	C091-13	293, 295, 309, 315	Spray-Test, free and time flow determination	C181	330, 332, 333
Slake durability apparatus	A130	65	Stability mould Marshall	B046N	121-127, 131
Slaking vessel, lime EN 459-2	E035	386	Stability verification	C155N	325
Sleeves, metal	V220-02	600	Stabilized soil strength	S195-01	491
Slump cone, Abrams	C178 KIT	332	Stands, metal	V219	600
Slump flow table, concrete	C192 KIT	333	Static elastic modulus, concrete	C130N	287
Slurry, cohesion test	B053-10	136	Static testing system, STS-25	B225	208
Smartracker	B038A	114-117	Steam bath	E081-10	399
Soaking tank	S201-05	489	Steel, test on	H001A	434-439
Sodium hexametaphosphate	V300-23	474, 601	"Stiffening time of cement"	"E083-10"	400
Sodium hydroxide	V300-24	60, 469, 601	Still water	V211	599
Sodium sulfate	V300-25	601			

Stirrer for blue methylene test	S157-01	52, 475
Stirrer for particle size analysis of soils	S156-01 KIT	474
Stirrer/heater, magnetic	B073-01	150, 472, 596
Stirring rods	V147	586
Stock solution	S158-09	50, 476, 477
Stop watch	V170	50, 476, 592
Storage stability of asphalt emulsions	B063-05	143
Straight edge, MOT	B099 KIT	166
Strain gauge load cells	S337-31	129, 503, 505, 548
Strain gauges, concrete	C360 KIT	359
Strain gauges, single use, concrete	C125-10	69, 285, 431
Strain transducers	S336-15	129, 505, 549
Strain, ductility, concrete	C104-10N	282, 283
Strength index, rocks	A125N	64, 323
STS-25 static testing system	B225	208
Submersible load cells	S337-02	548
Sulphate test strips	A019-03	28, 472
Sulphur capping method	C290-01	351
Survey, resistivity measuring instrument	S077	468
Surveymaster, moisture meter	C374	364
Swelling and settling ratio	E036 KIT	387

<b>T</b>	<b>Mod.</b>	<b>Page</b>
Table vibrators, concrete	C278	344
Table, flow of concrete	C208	338
Table, flow of mortar	E086 KIT E090-01 KIT	401
Tag closed/open viscometers	B092 KIT	155
Tamping bar	C261	343
Tanks curing, concrete	C302 KIT	346
Tar (Redwood) viscometers	B084-01 KIT	153
Telescopic tubular sensor	C405-10	377
Temperature measurement	V150	590
Temperature monitoring	C216	338
Temperature/humidity cabinet	C313N	26, 348
Temperature/humidity equipment	C309-10	347
Tensile machine for steel, servo-controlled hydraulic grips	H001A	434-439
Tensile splitting device, asphalts	B047-02	121, 123, 127, 131, 511
Tensile splitting, concrete	C100	314
Tensile steel testing machines	H001A	434-439
Tensile test on mortar briquettes	S205-05N	416, 452, 500-507
Tensile/compression machines	H010	446
TestLab software	/	170
Texture surface apparatus	B099-10	164
TFOT oven	B064 KIT	149
Thermal properties of aggregates	A103-10	61
Thermal shock resistance	A023-01N	25, 63
Thermohygrograph	V168	589
Thermo-hygrometer	V165	410, 592
Thermometer, four channel, concrete	C216	338
Thermometer, infrared	V155	590
Thermometers	V150	590
Thermometers, armoured	V162	591
Thermostats, concrete curing	C302-01	346

Thickness gauge	A070	45
Thin-Film and loss on heating determination, asphalt	B064 KIT	149
Thin-Film ovens	B066M KIT	148
Tiles, test on	C095	323
Tilt Test	A122-10	66, 86
Timing device	V171	592
Tins, metallic	V122	481, 594
Tongs, crucible	V174	161, 593
Tool kit	V222	600
Tools for tests on soil	S240-01	523
Top loading digital balances	V070-02	581
Toughness determination, concrete	C090-16	303, 305
Transducers, linear vertical displacement for geotechnical test	S336-11	528, 540, 549
Transducers, pressure for soil	C116-01N	318
Transducers, pressure, for geotechnical test	S336-50	552
Transfer dish	B057-03	139, 140
Transverse/deformation test	S205-13	506
Travelling beam device	B098N	165
Trays, mixing	V182	343, 594
Trays, screen	A061-07	43
Triaxial cells	S305	503, 546, 563
Triaxial equipment	S301N	544, 545
Triaxial tests on rock, Hoeck cells	A136	71
Triaxial tests	/	543
Triaxlab Automated System	S301-01	561-563
Triaxlab Automated System, Cyclic	B220-03 KIT	567
Tribometer-Abrasimeter	A112	59
Trimmer, soil lathe	S120	471
Trimming knife	S125	471, 595
Trimming/cut off machine for concrete cores	C377-05	354
Triple beam balance	V016	578
TRL dynamic cone penetrometer	S051	460
Trolley	V224	600
Trowels	V187	343, 595
TSRST, multi station thermal asphalt system	B282-10	207
Tubing, rubber	V230	600
Two-Three frames, combined	C092	310
Two-way hydraulic valve	C115-01	318

<b>U</b>	<b>Mod.</b>	<b>Page</b>
Ultrasonic "cross-hole" test system	C373-10N	367
Ultrasonic cleansing bath	A104N	37
Ultrasonic pulse velocity, concrete	C369N	63, 371
Unbonded capping pads and retainers	C107-09	316, 350
Unconfined compression tester, soil	S131 KIT	492
Unconfined test program	S218-01N	133, 499, 50
Uniaxial splitting, rock	S205N	126, 321, 500-507
Unit weight measurers, concrete	C199	337
Unit weight measures	C200	337
Unitracker wheel tracking	B038	112
Unitronic 200 kN universal multipurpose frame	S206N	130, 322, 508-513



Unitronic 50 kN universal multipurpose frame	S205N	126, 321, 500-507
Universal digital tester for load cells	C138N	146, 326, 448
Universal flexural and transverse machine, concrete	C095N / C093-02N	296, 308
Universal multispeed load frames, soil/bitumen	S212N/S216 KIT	124, 494-496
Universal servo-controlled testing machines, steel	H001A	434-439
Universal tensile/compression machine steel/ concrete	H010	446
Universal testing machines, servo-controlled electromechanical, steel	H004N / H008N	442-449
U-shape box, confined flowability	C173	330

V	Mod.	Page
Vacuum degassing Oven	B091M-01	159
Vacuum pumps	V203	83, 526, 597
Vacuum pycnometer 10 litres, bitumen	B067N	84
Valve, automatic hydraulic	C115N	318
Vane shear, pocket for soil	S057	460
Vaporiser, curing rooms	C311-01	347, 350
Vaseline oil	S328	546
VDO, Vacuum Degassing Oven	B091M-01	159
Vebé consistometer	C183	331
Verification of force transfer	C155N	325
Vernier calipers	V175	593
V-Funnel flow time	C171	330
Vialit, binder adhesion tester	B053	136
Vibrating compaction hammer, soil, bitumen	S197N1	97, 490
Vibrating machine mortar cubes 70,7 mm	E132	409
Vibrating table, Vebé	C184N	331
Vibrating tables	C278, C281N	344
Vibrators, poker	C272	345
Vibro-deaerator	A059-02 KIT	84
Vicat apparatus, manual	E055N	389
Vicatronic, automatic Vicat apparatus	E044N	390
Viscometer bath	B088N	162
Viscometer, Marsh funnel for cement	E037	388
Viscometers Asphalt Institute	B088-34	163
Viscometers, BS-IP-RF flow reverse	B088-80	163
Viscometers, Cannon Fenske	B088-50	163
Viscometers, Cannon Manning	B088-20	163
Viscometers, Engler	B080	153
Viscometers, Pensky-Martens	B094 KIT	155
Viscometers, Redwood /TAR/BRTA	B084-01 KIT	153
Viscometers, Saybolt	B087	154
Viscometers, Tag closed/open	B092 KIT	155
Viscometers, Zeitfuchs cross-arm	B088-70	163
Void content of fine aggregate	A071-10	37
Void content of dry filler	A124	53
Void content of aggregates	A069	31
Voltage stabilizer	V208-10	598
Volume change, burette (triaxial)	S358	553
Volume gauge instrument (triaxial)	S338N	553
Volumeter for aggregates	A086	53
Volumetric flasks, glass	V109	584

W	Mod.	Page
Walz consistometer	C188	334
Warm air dryer	V201	598
Wash bottles	V120	587
Washing sieves	A045	36
Watch glass	V115	585
Watch, stop	V170	50, 476, 592
Water bath for penetrometer, bitumen	B058	139, 142
Water bath with cooling device, digital	B052-02	123, 135, 410
Water bath, aggregates	E136 / E139	410
Water bath, soil	E136 / E139	410
Water bath: Le Chatelier	E064N	398
Water baths, curing of cement	E136 / E139	410
Water baths, Marshall	B051	134, 135
Water flowing sieves device, cement	E016	385
Water impermeability tester, concrete	C435	380
Water in bituminous materials	B076	147
Water level indicator, soil	S061	463
Water permeability one-coat, mortar	E035-10	394
Water permeability testers, concrete	C430	379
Water refrigerator	E141	347, 411
Water retention apparatus, cement	E039-01	387
Water sensitivity, bitumen	B052-02	123, 135, 410
Water stills	V211	599
Water test set for concrete	C220	335
Water vapour permeability	E082-11N	399
Wax paraffin	V300-19	28, 88, 395, 601
Wax, melting pot	A106	28, 88, 351, 464
Weather station	V148	589
Weighting bottles	V110	585
Weights for balances	V036	579
Weights, slotted for oedometer and shear test machines	S273 KIT	530, 553 537
Welded wire nets test	H003-14	441
Wet sieving pan+lid, stainless steel	A046	36
Wet washing sieves	A045	36
Whatman paper	V218-01	601
Wheel tracking apparatus, asphalt	B038	112
Wheelbarrow	V226	600
Wheeltracker, Hamburg	B038A	114-117
Wilhelmi, softening point apparatus	B072-20	143
Windsor pin penetrometer	C410-10	376
Windsor probe	C410	376
Wire strands extensometer	H003-18	441
Workability apparatus, cement	E081	399
Workability apparatus, concrete	C189	334
Workable life and correction time of fresh mortar	E083-10	400

Y	Mod.	Page
Yield of lime	E035	386

Z	Mod.	Page
Zeitfuchs cross-arm viscometers	B088-70	163

AASHTO	Page
AASHTO M320	157
AASHTO M332	157
AASHTO PP75	89
AASHTO R28	159
AASHTO T100	54, 479
AASHTO T107	396
AASHTO T119	332
AASHTO T126	342, 343, 345, 351
AASHTO T127	385
AASHTO T131	389, 390
AASHTO T132	408, 416, 417, 506
AASHTO T133	385
AASHTO T134	484
AASHTO T137	385
AASHTO T142	30
AASHTO T152	336
AASHTO T153	384
AASHTO T154	389
AASHTO T162	402, 404
AASHTO T164A	80
AASHTO T166	88
AASHTO T176	50, 51, 476-478
AASHTO T179	149
AASHTO T180	484, 486
AASHTO T19	337
AASHTO T191	524
AASHTO T193	486, 488, 492, 493, 503, 511
AASHTO T197	335
AASHTO T201	163
AASHTO T202	162, 462, 464
AASHTO T205	523
AASHTO T208	492, 503, 507, 513
AASHTO T209	85
AASHTO T21	60, 469
AASHTO T215	526
AASHTO T216	528
AASHTO T217	473
AASHTO T22	229-278, 316, 350, 446
AASHTO T23	342, 343, 345, 346, 351
AASHTO T235	536
AASHTO T237	49
AASHTO T240	148
AASHTO T245	96-97, 121-122, 127, 131, 134, 504, 511
AASHTO T256	166, 167
AASHTO T260	365
AASHTO T27	31
AASHTO T277	366
AASHTO T283	121, 123, 127, 131, 133, 504, 511
AASHTO T300	145
AASHTO T301	145
AASHTO T307	187
AASHTO T307-9	567
AASHTO T308	79
AASHTO T310	466
AASHTO T312	98, 100, 103
AASHTO T313	157
AASHTO T314-12	208

AASHTO T315	157
AASHTO T316	157, 160
AASHTO T321	184, 193
AASHTO T322	184
AASHTO T324	114, 115, 116
AASHTO T331	89
AASHTO T336-11	370
AASHTO T342	186
AASHTO T344	105
AASHTO T350	157
AASHTO T378	188
AASHTO T40	142
AASHTO T47	149
AASHTO T48	154
AASHTO T49	138, 140, 141
AASHTO T51	144, 145
AASHTO T53	150, 151
AASHTO T54	153
AASHTO T55	147
AASHTO T59	143
AASHTO T72	154
AASHTO T73	155
AASHTO T78	147
AASHTO T84	54, 582
AASHTO T85	88, 582
AASHTO T851	316, 350
AASHTO T86	461, 462
AASHTO T87	31
AASHTO T88	474
AASHTO T89	480
AASHTO T90	481
AASHTO T92	481
AASHTO T96	46
AASHTO T97	290-295, 308, 315, 322, 512
AASHTO T99	484, 486
AASHTO TP10	190
AASHTO TP105-13	208
AASHTO TP107-14	191
AASHTO TP10-93	202, 208
AASHTO TP124	128, 189, 208, 505
AASHTO TP31	182
AASHTO TP33	37
AASHTO TP4	98
AASHTO TP53	79, 92
AASHTO TP79-09	188

ACI	Page
ACI 347	376

AG:PT	Page
AG:PT	184

ALP	Page
ALP A SIB T.4	123, 127, 131, 504, 511

AMAAC	Page
AMAAC Mex Protocol	116

API	Page
API 509	155
API recommended practice 13B-1 and 2	388

AS	Page
AS 1289	486
AS/NZS 2891.12.1	185
AS/NZS 2891.13.1	182

ASTM	Page
ASTM 03	184, 193
ASTM 303	56
ASTM 702	31
ASTM A370	434, 440, 449
ASTM A615	454
ASTM A615M	454
ASTM C1018	303, 305
ASTM C1040	466
ASTM C109	410, 411, 416-428, 315, 505, 513
ASTM C110	387
ASTM C114	365
ASTM C117	52
ASTM C1170-14	331
ASTM C1194	418, 422, 426, 428
ASTM C1202	366
ASTM C1231	316, 350
ASTM C124	338
ASTM C1252	37, 45
ASTM C1260	399
ASTM C127	23, 24, 54, 88, 582
ASTM C128	54, 582
ASTM C131	46, 86
ASTM C1314	246, 254, 266, 274
ASTM C136	23, 24, 31
ASTM C1362	334
ASTM C138	337
ASTM C1398	389
ASTM C140	246, 254, 266, 274
ASTM C141	389
ASTM C143	332
ASTM C151	396, 397
ASTM C1550	296, 298, 300, 302
ASTM C1567	399
ASTM C1609	283, 293, 303, 305
ASTM C1760	366
ASTM C183	385
ASTM C185	385
ASTM C186	395
ASTM C187	390
ASTM C188	385
ASTM C190	408, 410, 416, 417, 506
ASTM C191	389, 390, 410
ASTM C192	342, 345, 346, 351
ASTM C204	384
ASTM C215	370
ASTM C227	62, 399
ASTM C230	401

ASTM C231 type A and B	336
ASTM C266	389
ASTM C289	30, 55
ASTM C29	322, 337
ASTM C293	290-301, 308, 315, 321, 322, 506, 507, 512
ASTM C29-97	31
ASTM C305M	402, 404
ASTM C307	408, 416, 417, 506
ASTM C31	345, 346, 351
ASTM C348	408, 416, 417, 422-428, 505, 513
ASTM C349	296, 315, 416-418, 422-428, 505, 513
ASTM C360	334
ASTM C39	229-258, 262-278, 342, 343, 446
ASTM C40-11	60, 469
ASTM C403	335
ASTM C426	359
ASTM C438	396
ASTM C469	69, 284, 286, 287
ASTM C490	396, 397
ASTM C496	296, 314, 322, 512
ASTM C497	307
ASTM C511	410, 411
ASTM C597	371, 372
ASTM C617	351
ASTM C666	370
ASTM C671	61
ASTM C682	61
ASTM C684	347
ASTM C70	30, 322
ASTM C702	53
ASTM C78	290-301, 308, 315, 321, 322, 506, 507, 512
ASTM C803	376
ASTM C805	64, 368, 369,
ASTM C876	375
ASTM C88	61
ASTM C900	363
ASTM C91	387, 389
ASTM D1067	472, 599
ASTM D113	144, 145
ASTM D1186	88
ASTM D1194	514
ASTM D1195	514, 516-519
ASTM D1196	514, 516-519
ASTM D1310	155
ASTM D140	142
ASTM D1452	462
ASTM D1452	461
ASTM D1556	524
ASTM D1557	23, 24, 484, 486, 487
ASTM D1558	465
ASTM D1559	23, 24, 121, 122, 127, 131-134, 504, 511
ASTM D1587	470
ASTM D1665	153
ASTM D1754	149
ASTM D1856	81, 83
ASTM D1883	133, 470, 486, 488, 492, 493, 503, 511
ASTM D2041	84, 85
ASTM D2042	152

ASTM D2166	133, 492, 503, 507, 513	ASTM D559	23, 24, 486
ASTM D2167	523	ASTM D56	155
ASTM D217	138, 141	ASTM D560	23, 24
ASTM D2170	162, 163	ASTM D5607	67
ASTM D2171	162	ASTM D5731	64
ASTM D2172	76, 78, 80, 83	ASTM D5873	64
ASTM D2196	160	ASTM D5874-02	490
ASTM D2-33	47	ASTM D6	149
ASTM D2419	50, 51, 476, 477, 478	ASTM D6084	144, 145
ASTM D2434	526	ASTM D6307	79, 92
ASTM D2435	528	ASTM D6521	159
ASTM D2435-80	531, 533, 534	ASTM D6648	157
ASTM D244	143, 147	ASTM D6752	89
ASTM D2573	460, 464	ASTM D6758	467
ASTM D2664	68, 70, 285	ASTM D6760-02	367
ASTM D2726	88	ASTM D6857	89
ASTM D2850	503, 543, 561, 567	ASTM D6925	98, 100, 103
ASTM D2850-03a	554	ASTM D6926	95-97, 127
ASTM D2872	148	ASTM D6927	121, 122, 124, 127, 131-134, 511
ASTM D2937	463	ASTM D6928	49
ASTM D2938	71	ASTM D6931	121
ASTM D2950	466	ASTM D6938	466
ASTM D3080	536, 539, 542	ASTM D6951-3	460
ASTM D3143	155	ASTM D698	23, 24, 470, 484, 486, 787
ASTM D3148	68, 70, 285	ASTM D70	146, 585
ASTM D36	150, 151	ASTM D7012	68, 70
ASTM D3667	503	ASTM D7063	89
ASTM D3877	528	ASTM D7115	105
ASTM D3910	136	ASTM D7175	157
ASTM D3999	567	ASTM D7181	543, 554, 561, 567
ASTM D402	147	ASTM D7227	89
ASTM D4123	182	ASTM D7313-07a	190, 208
ASTM D420	462	ASTM D7369	184
ASTM D420	461	ASTM D7428	49
ASTM D422	474	ASTM D7460	184
ASTM D4253	522	ASTM D7698	467
ASTM D4254	522	ASTM D7870	89
ASTM D427	481	ASTM D7981-15	110
ASTM D430	385	ASTM D8044	128, 208, 505
ASTM D4318	480, 481	ASTM D8079	107
ASTM D4402	157, 160	ASTM D854	54, 479, 584
ASTM D4429	492	ASTM D88	154
ASTM D4543	65, 352	ASTM D92	154
ASTM D4546	528	ASTM D93	155
ASTM D4644	65	ASTM D95	147
ASTM D4647	525	ASTM E 2835-11	521
ASTM D4767	543, 561, 567	ASTM E11	33, 34, 43
ASTM D4767-95	554	ASTM E23	456
ASTM D4791	45	ASTM E290	441
ASTM D490	153	ASTM E303	56, 168
ASTM D4944	473	ASTM E4	442, 446
ASTM D4965-03	166, 167	ASTM E74	326, 327
ASTM D5	138, 140, 141	ASTM E8	434, 440
ASTM D5311	567	ASTM E965	164
ASTM D5404	84	ASTM G57	468
ASTM D5407	68, 70, 285	ASTM WK26816	192, 208, 210
ASTM D558	23, 24, 484		
ASTM D5581	96, 97, 121-125, 127, 131-134, 504, 511		

BS	Page
BS (DD)	79
BS 1191	398, 400
BS 131	456
BS 1377	487, 503
BS 1377:1	24
BS 1377:2	31, 54, 60, 138, 140, 141, 473, 475, 479-482
BS 1377:3	28, 468, 472, 599
BS 1377:4	97, 465, 470, 484-490, 492, 493, 503, 511
BS 1377:5	525, 526, 528, 531, 533, 534
BS 1377:7	492, 503, 507, 513, 536, 542, 561, 567
BS 1377:8	543, 554, 561, 567
BS 1377:9	463, 492, 514-519, 525
BS 1610	229-258, 326, 446
BS 1881	217, 396, 397
BS 1881:101	595
BS 1881:102	332
BS 1881:103	333
BS 1881:108	342, 343, 344
BS 1881:112	347
BS 1881:114	337, 582
BS 1881:115	262-280, 325
BS 1881:117	322, 512
BS 1881:118	290, 294, 308, 315, 321, 322, 507, 512
BS 1881:121	286
BS 1881:14	54
BS 1881:201	375
BS 1881:202	368, 369
BS 1881:203	371, 372
BS 1881:204	374
BS 1881:206	359
BS 1881:207	363, 376, 406
BS 1881:209	370
BS 1881:5	397
BS 1888:121	284
BS 1924	487
BS 1924:1	23, 24, 31
BS 1924:2	97, 470, 484, 488-492, 525
BS 1990	486
BS 1994	486
BS 2000	149, 150, 151, 153
BS 3892	505
BS 410	33, 34, 35,
BS 4359:2	384
BS 4550	315, 390, 409, 418-428
BS 4551-1	387, 401
BS 5911	307
BS 598	470
BS 598:102	83
BS 598:107	94, 121, 122, 127, 131, 133, 499
BS 598:110	112
BS 600	516, 517, 518, 519
BS 6073	246, 247, 254, 255, 266, 267, 274, 275, 396, 397
BS 6073-1	292, 294, 308
BS 6463	398
BS 6463-4	387
BS 6576	473
BS 6717	59

BS 7263	292, 294, 308
BS 7976	56, 57, 168
BS 812	31, 47, 52-54, 337, 479
BS 812:1	31
BS 812:102	62
BS 812:105.1	32, 45
BS 812:110	53
BS 812:114	58, 168
BS 812:117	28, 472
BS 812:124	61
BS 812:2	54, 582
BS 812-113	59
BS 890	398

CEN ISO	Page
CEN ISO-TC 178	59
CEN ISO-TS 17892-06	482
CEN ISO-TS 17892-11	526, 527
CEN ISO-TS 17892-12	482
CEN ISO-TS 17892-5	533

CNR	Page
CNR 134	127, 131, 504, 511
CNR 63	31
CNR 64	31
CNR 69	486
CNR N.100	143
CNR N.101	147
CNR N.102	153
CNR N.105	58, 168
CNR N.109	48
CNR N.113	45
CNR N.123	53
CNR N.133	83
CNR N.141	166
CNR N.146	514-519
CNR N.22	463, 523, 524
CNR N.27	51, 476-478
CNR N.29	486
CNR N.34	46
CNR N.35	151
CNR N.4	60
CNR N.50	149
CNR N.62	31
CNR N.69	484, 487
CNR N.80	61
CNR N.81	142
CNR N.92	514-519
CNR N.95	45
CNR N.98	142
CNR N.99	143
CNR UNI 10009	486-488, 492, 493, 503, 511

D.M.	Page
D.M. 14/1/1988	454
D.M. 3/6/68	385

DIN	Page
DIN 1045	374
DIN 1048	69, 284-286, 333, 334, 336, 368, 369, 380
DIN 1060	387, 408
DIN 1164	390, 397, 408, 418-428, 505, 513
DIN 1164-5	402, 404
DIN 1164-7	402
DIN 1168	389, 390, 393
DIN 1196	390
DIN 12039	54
DIN 18127	484-486
DIN 18134	514
DIN 1996-15	143
DIN 4030	335
DIN 4035	307
DIN 4094	460
DIN 4187-1	33-35
DIN 4226	45
DIN 51220	262-280, 326, 446
DIN 51302	325
DIN 51804	141
DIN 52011	150, 151
DIN 52108	58, 324
DIN 52210	138

DUTCH RAW	Page
DUTCH RAW	486

EN	Page
EN 10002	434, 440, 446
EN 10002-1	449
EN 10002-3	326, 327
EN 10045-1	456
EN 1008	335
EN 10080	434, 440
EN 101	63
EN 1015-11	416-428
EN 1015-12	363, 406, 407
EN 1015-19	399
EN 1015-21	394
EN 1015-3	401
EN 1015-4	400
EN 1015-7	386
EN 1015-9	400
EN 102	59
EN 10545-6	59
EN 10834	283
EN 1097-2	86
EN 1097-3	31
EN 1097-4	53
EN 1097-5	23, 24
EN 1097-6	54, 136, 337, 479, 582, 583
EN 1097-7	54
EN 1097-8	56, 58, 59, 168
EN 11039-2	303, 305
EN 11039-3	283
EN 1170-4	322, 506, 512
EN 12	504, 511

EN 12004	27, 349
EN 12004-2	506
EN 12272-1	136
EN 12272-3	136
EN 12274-3	136
EN 12274-4	136
EN 12274-5	136
EN 12350-1	333, 595
EN 12350-10	330
EN 12350-12	331
EN 12350-2	332
EN 12350-3	331
EN 12350-4	334
EN 12350-5	333
EN 12350-6	337
EN 12350-7	336
EN 12350-8	330, 332
EN 12350-9	330
EN 12390-1	339, 342, 343
EN 12390-13	284
EN 12390-14	286
EN 12390-2	26, 65, 328, 329, 344-348, 352
EN 12390-3	351
EN 12390-4	262-280, 325, 442, 490
EN 12390-5	290-301, 308, 315, 321, 322, 441, 506, 507, 512
EN 12390-6	296, 314, 322, 512
EN 12390-7	54, 88, 337, 582
EN 12390-8	380
EN 12390-9	26, 348
EN 12504-2	368, 369
EN 12504-3	363
EN 12504-4	371, 372
EN 12592	152
EN 12593	146
EN 12595	163
EN 12596	162
EN 12607-1	148
EN 12607-2	149
EN 12607-3	152
EN 12617-4	396, 397
EN 12697	582
EN 12697-1	76, 78, 80-82
EN 12697-1 clause B.1.1	82
EN 12697-1 clause B.1.2	82
EN 12697-1 clause B.1.3	82
EN 12697-1 clause B.3.1	83
EN 12697-1 clause C	25, 79
EN 12697-10	94, 97, 98, 100, 103, 490
EN 12697-11	86
EN 12697-12	122, 123
EN 12697-13	88
EN 12697-17	46, 86
EN 12697-18	88
EN 12697-20	87
EN 12697-22	112, 114, 115
EN 12697-23	121-125, 127, 131-133, 497-499, 504, 511
EN 12697-24 Annex A	185

EN 12697-24 Annex D	184, 193	EN 1338	56, 58, 59, 296, 314, 322, 324, 512
EN 12697-24 Annex E	182	EN 1339	58, 59, 296, 297, 300, 301, 324
EN 12697-25 Test Method A	183	EN 13395-2	394
EN 12697-25 Test Method B	187	EN 13398	144, 145
EN 12697-26 Annex A	185	EN 1340	58, 59, 296, 297, 300, 301, 315, 324
EN 12697-26 Annex B	184, 193	EN 1340-4	292, 294, 308
EN 12697-26 Annex D	191	EN 1341	56, 58, 59, 168, 324
EN 12697-26 Annex E	191	EN 13412	284, 286, 430
EN 12697-27	164	EN 1342	56, 58, 59, 168, 324
EN 12697-3	84	EN 1343	58, 59, 168
EN 12697-30	94	EN 1344	59
EN 12697-31	98, 100, 103, 105	EN 13450	48
EN 12697-32	97, 490	EN 1348	27, 349, 363, 406, 407
EN 12697-33	106, 107	EN 13589	144, 145
EN 12697-34	122, 125, 127, 131-134, 499, 504,511	EN 1367-1	26, 27, 61, 348, 349
EN 12697-35	92	EN 1367-2	61
EN 12697-39	79	EN 1367-4	62, 397
EN 12697-40	164	EN 1367-5	63
EN 12697-43	46, 86	EN 13687-2	363, 406
EN 12697-44	128, 188, 505	EN 13702	157
EN 12697-46	190, 202	EN 13703	145
EN 12697-5	84	EN 13748-2	58, 324
EN 12697-6	88	EN 13880-2	141
EN 12697-9	97, 490	EN 13880-3	141
EN 12808-2	59	EN 13892-3	58, 324
EN 12808-4	396, 397	EN 13963	363, 406
EN 12808-5	408	EN 14157	58, 59, 324
EN 12846-01	153	EN 1426	138, 140, 141
EN 12846-02	153	EN 1427	150, 151
EN 12847	147, 152	EN 1428	147
EN 12848	147	EN 1429	147
EN 12849	152	EN 1430	143
EN 13036-1	164	EN 1431	143
EN 13036-4	56, 57, 168	EN 1436	56
EN 13036-7	166	EN 14487-1	283
EN 13055-1 method 1 and 2	45	EN 14488-3	283, 303, 305
EN 13075-1	142	EN 14488-5	283, 295, 296, 298, 300, 302, 303, 306
EN 13108	25, 79	EN 14496	363, 406
EN 13108-6	87	EN 14580	68, 70, 285
EN 13266-4	97	EN 14617-4	59
EN 13279-2	389, 390, 393, 401	EN 14651	303, 305
EN 13286 -47	503, 511	EN 14651-05	283
EN 13286-2	470, 484, 485, 487	EN 14769	159
EN 13286-4	488, 490	EN 14770	157
EN 13286-41	422, 423, 426, 490	EN 14771	157
EN 13286-43	284, 286	EN 15037	295, 309, 321, 322
EN 13286-46	465	EN 15037-2	293, 506, 513
EN 13286-47	133, 470, 486-489, 492, 493, 499	EN 15037-3	293, 506, 513
EN 13286-5	522	EN 15366	164
EN 13286-53	491	EN 154	63
EN 13294	400	EN 1542	363, 406
EN 13295	364	EN 15630-1	434, 440, 446
EN 13302	160	EN 15630-3	434, 440
EN 13303	149	EN 16659	157
EN 13357	153	EN 1871	143
		EN 1916	307
		EN 1926	68, 70, 285,
		EN 196	296

EN 196-1	26, 315, 348, 402, 404, 408-411, 416-419, 422-428, 505, 513
EN 196-2	25, 394
EN 196-21	25, 394
EN 196-3	389, 390, 398, 402, 404
EN 196-6	384, 385
EN 196-7	385
EN 196-8	395, 411
EN 196-9	395
EN 1997-2	60
EN 206	335
EN 22592	154
EN 22719	155
EN 413-2	386, 399, 400, 402, 404
EN 445	387, 388
EN 451-2	385
EN 459-1	398
EN 459-2	25, 386, 387, 394, 399-402, 404,
EN 480-1	402, 404
EN 480-2	389, 390
EN 480-4	337
EN 491	507
EN 50081-1	434
EN 538	507
EN 58	142
EN 7500-1	434, 440, 442, 446
EN 772-1	246, 247, 254, 255, 266, 267, 274, 275
EN 932-5	23, 24, 40, 42, 61
EN 933-10	38, 51, 478
EN 933-11	52
EN 933-2	33, 34, 35, 43
EN 933-3	31, 32, 55
EN 933-4	45
EN 933-5	45, 422, 423, 426
EN 933-6	45, 55
EN 933-7	45
EN 933-8	50, 51, 476-478
EN 933-9	52, 475, 587

EN ISO	Page
EN ISO 10545-7	63
EN ISO 148-1	456
EN ISO 15630-1	454
EN ISO 376	326, 327
EN ISO 3838	146, 585
EN ISO 679	408-411, 418-428, 505, 513
EN ISO 6892	442
EN ISO 6892-1	434, 440, 446
EN ISO 7438	454
EN ISO 9597	398

ERMCO-EFNARC	Page
ERMCO-EFNARC	330

GOST	Page
GOST 11505-75	145
GOST 26798-1	418-428
GOST 33138-2014	145

GOST 10180-2012	229...280
-----------------	-----------

IP	Page
IP 179	141
IP 184	153
IP 222	162
IP 34	155
IP 35	155
IP 36	154
IP 485	152
IP 487	152
IP 49	138
IP 494	142
IP 74-77	147

ISO	Page
ISO 1042	584
ISO 10545-6	59
ISO 178	449
ISO 2137	141
ISO 2431	388
ISO 2592	154
ISO 2719	155
ISO 3310-1	33, 34, 40-43
ISO 3310-2	33, 35, 43
ISO 3506-1	449
ISO 4624	363
ISO 527	449
ISO 565	33
ISO 604	449
ISO 6784	69, 284, 286
ISO 6872	31
ISO 898-1	449

ISRM	Page
ISRM	64, 67, 68, 285

ITALIAN HIGHWAY SYSTEM	Page
ITALIAN HIGHWAY SYSTEM	164

LCPC	Page
LCPC French Method	335

MPW BEGIUM	Page
MPW BEGIUM	164

NCAT	Page
NCAT (National Centre for Asphalt Technology)	79

NF	Page
NF P094-071-2	536
NF P15-413	408
NF P15-414	389, 390
NF P15-431	389, 390
NF P15-432	398
NF P15-433	396, 397
NF P15-434	397, 400



NF P15-451	505, 513
NF P18-054	479
NF P18-305	332
NF P18-358	388
NF P18-400	342, 343
NF P18-401	408
NF P18-407	322, 512
NF P18-408	314, 322, 512
NF P18-411	229-239, 246-280, 326, 370, 446
NF P18-416	351
NF P18-417	368, 369
NF P18-418	371, 372
NF P18-427	397
NF P18-452	334, 399
NF P18-507	388
NF P18-553	31
NF P18-558	54
NF P18-561	32
NF P18-564	45
NF P18-572	48
NF P18-573	46
NF P18-574	47
NF P18-575	58, 168
NF P18-576	48
NF P18-577	47
NF P18-858	363, 406
NF P94-048	30
NF P94-051	480, 481
NF P94-051-1	480
NF P94-052-1	482
NF P94-054	479
NF P94-061-2	523
NF P94-061-3	524
NF P94-066	486
NF P94-068	52, 475
NF P94-070	543, 554, 561,
NF P94-071-1	536, 539, 542,
NF P94-071-2	539, 542
NF P94-074	543, 554, 561,
NF P94-078	133, 484, 488, 492, 493, 499, 503, 511
NF P94-093	484, 486, 488
NF P94-100	491
NF P94-117-1	167, 516, 519
NF P98-216-1	164
NF P98-102	386
NF P98-200-2	166, 167, 519,
NF P98-230-2	491
NF P98-231-1	484, 488
NF P98-251-1	112, 131, 511,
NF P98-251-2	94, 121, 122, 127, 131-133, 499, 504, 511
NF P98-251-4	112, 131, 511
NF P98-274-1	136
NF T60-118	154
NF T66-003	147
NF T66-004	138, 140, 141
NF T66-005	153
NF T66-007	146
NF T66-008	150, 151

NF T66-011	149
NF T66-020	153
NF T66-022	143
NF T66-023	147
NF X11-504	33, 34
NF XP18-598	50, 51, 476-478
NF XP94-060-1	481

NLT	Page
NLT 123	147
NLT 154	54
NLT 177	53
NLT 320	136
NLT 354	32, 45

RILEM	Page
RILEM DGZFP B3	375
RILEM report N. 23	330
RILEM TC 154-EMC	375

SHRP	Page
SHRP M-002	98, 100

TEX	Page
TEX-248-F	192, 200, 208

TP BF	Page
TP BF-StB part B 8.3	521

UNE	Page
UNE 103-104	481
UNE 103-108	481
UNE 103300	24
UNE 103-405	528
UNE 103-501	486
UNE 103-502	488
UNE 103-602	528
UNE 127024	59
UNE 7050	33, 34
UNE 7072	147
UNE 7110	149
UNE 7111	150, 151
UNE 7112	147
UNE 7136	61
UNE 7255	486
UNE 7365	486
UNE 7371	524
UNE 7377	480
UNE 7391	514
UNE 80102	398
UNE 83115	48
UNE 83120	31, 55
UNE 83131	50, 51, 476-748
UNE 83180	52, 475
UNE 83305	322, 512

UNI	Page
UNI 10014	480, 481
UNI 10157	363
UNI 10174	375
UNI 10532	59
UNI 10766	66, 354
UNI 10834	283, 295, 306,
UNI 11044	330
UNI 11307	362
UNI 11604	62
UNI 2331	33, 34
UNI 2333	33, 34
UNI 2334	33, 35
UNI 4161	150, 151
UNI 556	453
UNI 558	441
UNI 559	441
UNI 564	441
UNI 6132	352
UNI 6326	326
UNI 6394-2	54
UNI 6555	362
UNI 6556	69, 284, 286
UNI 6782	400
UNI 7123	335
UNI 7676	434, 439, 445
UNI 8020-14	60
UNI 8147	362
UNI 8148	362
UNI 8520	31, 397
UNI 8520-10	61
UNI 8520-15	50-52, 475-478
UNI 8520-18	32
UNI 8520-19	46
UNI 8520-20	61
UNI 8520-22	30, 62, 399
UNI 8520-6	31
UNI 85209-22	30
UNI 8942-3	321
UNI 8996	394
UNI 8997	394
UNI 8998	394
UNI 9189	369
UNI 9416	595
UNI 9535	375
UNI 9536	363
UNI 9730-3	321
UNI 9730-3	296, 309, 321-323, 506, 513
UNI 9771	370
UNI CNR 10009	133, 499
UNI JGJ/T 152	375
UNI JSCE E 601	375
ZTV	Page
ZTV E-STB 2017	521

A	Page		Page
A005-01 KIT / A005-08 KIT	22	A053-...	33, 34
A006-01	22	A054	33
A006-08	22, 23	A055	33
A007	22	A056 / A056-07	36
A007-51 / A007-53	22	A057 / A056-07	36
A008-01 KIT / A008-07 KIT	23	A057-31 / A057-46	44
A008-51 / A008-54	23	A058	41
A009	28	A058-01	44
A010	24	A058-05N	38, 51 478
A010-01 / A010-13	24	A058-14N, A058-15N	38
A019-01 / A019-03	28, 472	A058-20 / A058-97	39
A021	30	A059	41
A021-01	30	A059-01 KIT / A059-04 KIT	40
A021-10N	30	A059-02 KIT	84
A022N	25, 79	A059-02A	85
A023-01N	25, 63	A059-21	41
A023-11N	25	A060-01	44
A024N	25, 394	A060-31 / A060-50	44
A025 KIT, A026 KIT	29	A061-03 / A061-06	42
A027-01, A027-11	29	A061-07 / A061-96	43
A028	29, 364, 473	A061-97	42
A028-01	29	A061-98	42
A028-02	29	A061N	42, 43
A028-11	29, 473	A062, A062-02	31
A028-12	29	A062-11 / A062-48	43
A029	30	A063, A063-02	31
A030	30	A064, A064-02	31
A031	33	A065 / A065-04	31
A031-01 / A031-37	35	A066, A066-02	31
A032	33	A067, A067-02	31
A032-01 / A032-37	35	A068 / A068-11	31
A033	33	A069 / A069-04	31
A035 / A036-01	30, 479, 586	A070	45
A037	33	A071	45
A037-01 / A037-38	35	A071-10	37
A038	33	A072, A072-10	45
A038-01 / A038-38	35	A073N	45
A039	30, 479, 586	A075-11, A075-12	46
A040, A040-01	30, 479, 586	A075N	46, 86
A043	33	A076-01 / A076-02	46
A045	36	A076-11	46
A045-02 / A045-06	36	A077, A077-01	48
A046	36	A078, A078Y	49
A046-02, A046-11	36	A078-01 / A078-03	49
A047	36	A078-11N / A078-16	48
A047-02 / A047-11	36	A079, A079-02	47
A048-01 / A048-22	32	A080 KIT, A080-01 KIT	47
A048-14	32, 48	A080-02 / A080-04	47
A048N KIT	32	A081-01	45, 282
A049 KIT	32	A081-02	45
A049-01 / A049-07	32	A082 / A086	53
A049-02	32, 58	A087	47
A050	33	A091	55
A051	33	A091-02	55
A052-....	33, 34	A091-10 / A091-12	55
A052-37	34, 50, 476	A092	55
A052-44	34, 50, 476	A093, A093-11	55
		A095, A095-01	64

A101, A101N	62
A101-01N / A101-11N	62
A103	61, 582
A103-01 / A103-03	61, 582
A103-10, A103-11	61
A104N, A104-01N	37
A104-02, A104-03	37
A105	60, 400
A106	28, 88, 351, 464
A106-01	28
A107, A107-11	62
A107-20 / A107-23	63
A108	60
A109	63
A110-01 / A110-20	57, 168
A111-11, A111-12	59
A111N	59
A112, A112-10	59
A112-01, A112-05	59
A112-11	59
A113	56, 168, 324
A113-01	56
A115	63
A116-11, A116-12	60, 473
A117	60, 473, 475
A121	64
A122, A122-01	63
A122-10	66, 86
A124, A124-01	53
A125-01	64, 323
A125-02	64
A125N	64, 323
A126	64
A128-02 / A128-13	58
A128N	58, 168
A129	67
A129-01 / A129-04	67
A129-02	67, 72
A130, A130-11	65
A131, A131-01	67
A132, A132-01	63
A136	71
A136-01 / A136-04	71
A136-05	72
A137	71, 72
A137-02 / A137-04	71
A137-05	72
A138	71
A138-02 / A138-04	71
A138-05	72
A139	70, 71
A139-02 / A139-04	71
A139-05	72
A140-01	71
A141	71
A141-01 / A141-04	71
A142N	72
A144	72, 550

A147	71
A150-01N	69
A150N	68, 69, 70
A615, A615M	455

<b>B</b>	<b>Page</b>
B003	76
B003-01 / B003-18	77
B005, B005-10	79
B007, B007-11	85
B008	78
B008-01 / B008-11	78
B010-11 / B010-16B	80
B011	80
B011-01, B011-10	80
B014, B014-01	81
B016	141
B016-10, B016-15	82
B016-20 KIT, B016-23	82
B017 KIT	82
B017-01 / B017-05	82, 582
B018, B018-10	83
B019 KIT	83
B019-01 / B019-04	83
B020 KIT	83
B020-01 / B020-05	83
B021	81
B022SP	52
B022-12	86
B022-20, B022-21	88
B024	164
B024-01 / B024-10	164
B025-08, B025-09L	91
B026-05N	92
B026N	92
B027	91, 465
B027-01L / B027-11L	91
B027-03	91, 465
B027L, B027LSP	91
B028-01	90
B028-03	90, 405, 465
B029-01 / B029-04	97
B029-01 KIT	97
B029N KIT	94
B030 KIT	97
B030-01N	94, 97
B030-01NF, B030-02N	94
B030-03 / B030-05	94, 97
B030-06, B030-08	97
B030N	94, 97
B031-01	94
B031N1, B031	94
B032 KIT	95
B032-01	96
B032-05	96
B032-11	96
B033-01N	95
B033-03	95, 96

B033-04	95	B054-01 / B054-04	144
B033-11N	94	B055	144
B033N	95	B055-10 / B055-26	145
B034N	95, 96	B055-27 KIT	146
B035-01N	96	B055-28 KIT	146
B035-11N	96	B055-30 / B055-35	146
B035-12N	95, 96	B056 KIT	140
B035-13	96	B056-01 KIT	141
B036	95	B056-02 KIT	141
B037	95	B056-09	139, 141
B038	112	B057 KIT	140
B038-09 / B038-20	109, 113	B057-01, B057-01L	140
B038-14	113	B057-02	140, 483
B038A	114-117	B057-03	139, 140
B039	106-109	B057-04	140
B039-02 / B039-23	109	B057-04N	139
B039A	110	B057-05	140
B039A-01 / B039A-05	111	B057-05N	139
B040	118	B057-06 / B057-07L	139, 140
B040-01 / B040-14	119	B057-08	139, 140, 591
B040-20, B040-20Y	120	B057-09	139, 141
B040-21 / B040-33	120	B058	139, 142
B040-22 KIT, B040-23 KIT	120	B058-01	139, 142
B041	98-104	B058M	139, 393
B041-01 / B041-18	103	B059-10 / B059-21	87
B041-19 / B041-35	104	B059M	138
B041-28	105	B059M-11	139, 393
B041-50 / B041-55	105	B060	142
B042 KIT	121, 498	B061 KIT	82
B043 KIT	122	B061-01 KIT	82
B043-01	127	B061-02, B061-03	82
B043-01N	122, 125, 127, 131, 133, 499, 504, 511	B063 KIT	143
B043-02N	123, 125, 127, 131, 133, 499, 504, 511	B063-01	143, 591
B043-03N	123, 127, 131, 504, 511	B063-05 / B063-11	143
B043-05N	129, 505	B064 KIT	149
B044-03	123	B064-01 KIT	149
B044N	133	B064-02, B064-02SP	149
B044N SET	132, 133, 498, 499	B064-03	148, 591
B045-13, B045-14	129, 505	B064-04	149, 158
B046-02	124, 125, 127, 131	B065	84, 152
B046-03	121, 124, 127, 131	B065-12 / B065-16	84
B046N	121, 124, 127, 131, 494, 504, 511	B066-02N	148
B047	121, 124, 494	B066-11	148
B047-01	121, 124, 494	B066M KIT	148
B047-02	121, 123, 127, 131, 504, 511	B066N KIT	148
B047-02S	121, 123	B067A	85
B047-03	121	B067N	84
B047-04	123, 127, 131, 504, 511	B068	89
B047-10, B047-11	123, 127, 131, 504, 511	B069 KIT	147
B051	134, 135	B069-11	147, 591
B051-01, B051-02	134	B070-11 / B070-17	151
B052	135, 601	B070N1	151
B052-01	135	B072	150
B052-02	123, 135, 410	B072-01	150, 591
B052-10	135	B072-01 / B072-07	150
B053	136	B072-02	143, 150, 591
B053-01 / B053-23	136	B072-03	150, 151
B054	144, 145	B072-20	143

B073-01	28, 150, 472, 596	B099 KIT, B099N	166
B073-02	143, 150, 596	B099-01N	166
B074	28, 150, 596	B099-10 / B099-17	164
B074-01	150	B100	166, 519
B075	147	B100-02	166
B075-01 / B075-08	152	B102	166, 167, 519
B076	147	B103-05 KIT	167
B076-21 / B076-24	147	B103-10	167, 516
B077 KIT	146	B111	165
B077-01	146	B114	89
B077-02	146, 591	B114-11, B114-12	89
B079-01	147	B115	89
B079N	81, 147	B200	196
B080	153	B200-01	188
B081	153	B200-02	186
B082-01 / B082-04	153, 591	B200-03	186, 188
B082-05 / B082-07	153	B200-04	197
B083-01 / B083-10	153	B200-05 / B200-08	186, 199
B083-07	153, 591	B200-09	197
B084-01 KIT	153	B200-10	188, 197
B084-02 KIT	153	B200-11, B200-12	191, 199
B085-05, B085-07N	157	B200-13, B200-13X	197
B085-21 / B085-26	160	B201 KIT	197
B085-29 / B085-40	161	B201-52	182-191, 197, 199
B086 KIT	154	B201-53	187, 188, 197
B086-02	154	B202	186, 188, 191, 197, 199
B086-10	154, 591	B202-01 / B202-03	186, 191, 199
B087	154	B202-04	191, 197
B087-01	154	B203	186, 188, 197
B087-11, B087-12	154	B204 KIT, B204-01 KIT	192, 198
B088-01N / B088-08N	162	B204-01	192, 198
B088-12	162, 591	B204-02, B204-03	192, 198, 201, 210
B088-13	162, 591	B204-11, B204-11X	201
B088-16N, B088-17N	162	B204-13	192, 198, 201, 210
B088-20 / B088-90	163	B204-14	210
B088N	162	B205	170, 173, 193, 198
B089	140, 154, 591	B205-01 / B205-03	173
B089-01 / B089-05	154, 591	B206	170, 173, 174
B089-06 / B089-08	154	B207-01 KIT	198
B090	142	B207-01, B207-02	198
B090-10 / B090-20	142	B208	129, 189, 198, 505
B091M, B091M1	158	B210 KIT	193
B091M-01	159	B210-01	193
B092 KIT	155	B210-02, B210-03	184, 194
B092-10, B092-11	155, 591	B212	184, 194
B093 KIT	155	B215	200
B094 KIT	155	B215-01	209
B094-01 KIT	155	B220-01 KIT, B220-02 KIT	174
B094-10	155, 591	B220-03 KIT	567
B095-01	131, 511	B220-04 KIT	569
B095-02 / B095-07	131	B220-11, B220-12	174
B096-01	131, 511	B220-14	569
B096-02 / B096-07	131	B221	194
B097	97	B225	208
B097-11N, B097-12N	97, 490	B225-01, B225-02H	209, 210
B098-01N, B098-03N	165	B225-02V, B225-03V	209
B098-05 / B098-13	165	B225-03H	209, 211
B098N	165	B225-04	209

B225-09, B225-10	211
B230	176
B231/B233	177, 179, 181
B240	178
B240-02 / B240-10	179
B250 KIT	182
B250-01	129, 182, 184, 188, 505
B250-03 / B250-05	182
B250-06 KIT	182
B250-07 KIT	175, 177, 179, 194, 209
B250-08, B250-09	182
B250-10 / B250-13	175, 177, 194
B251 KIT, B251-01	182
B251-51, B251-52	182
B253 KIT	184
B253-01	184, 198
B253-02	184
B253-03	184, 198
B253-04	186, 191
B253-05	186, 191
B253-53	184, 186, 188, 189, 191, 197-199
B254 KIT	188
B254-01	129, 188, 505
B254-02	129, 189, 198, 505
B254-02 KIT	189, 198, 505
B254-10	129, 189, 198, 505
B254-11 / B254-15	189
B254-12	129, 189
B254-51	129, 188 505
B255 KIT	186
B260 KIT	183
B260-01	183, 185
B260-02	183
B260-03, B260-04	185
B260-05 / B260-10	183
B261 KIT, B262 KIT	185
B261-01	183, 190-192
B261-02	191, 192
B261-03	191
B264 KIT	191
B270-01 / B270-06	187, 188
B270-12	174, 193, 194, 569
B270-15	187
B270-16	188
B270-17	187
B270-18	187, 197
B270-20, B270-21	199
B271 KIT, B272 KIT	187
B274 KIT	188
B280 KIT	185
B280-01, B280-02	185
B280-51 / B080-53	185
B282 KIT	190
B282-01 / B282-08	190
B282-02, B202-08	190, 207
B282-10 / B282-18	207
B284-01	190, 207
B290-01	182

B290-02	183, 185, 187-189, 210
B290-03	182
B290-04	184, 198
B290-05	185, 189, 192
B290-06	186, 189, 191, 192
B290-07	188, 189, 190, 207
B290-09	190
B290-12	190, 207
B290-16	189
B292-01	175, 177, 194
B293-01	187, 188
B293-02	187

C	Page
C020 / C024D	230
C024N, C025N	231
C025A	230
C036/C041A	234
C036F	260
C040N, C041N	235
C041-11	232, 236, 240
C051F	260
C053 / C056A	238
C055N, C056N	239, 310, 311
C056-11	240
C058-02 / C058-05A	242
C058-04N, C058-05N	243
C058F	260
C066F	260
C068 / C071A	250
C070N, C071N	251
C073F	260
C075 / C078A	246
C077N, C078N	247
C079-01F	260
C079-03 / C079-06A	254
C079-05N, C079-06N	255
C086-02N / C086-03N	258
C086-10, C086-11	259, 279
C087-11, C087-15	281
C087N, C087-01N	280
C088-10N, C088-11N	278
C088N, C088-01N	280
C089, C089-01	262
C089B, C089-01B	266
C089-02D	262
C089-02N, C089-04N	263
C089-06 / C089-10A	270
C089-06F	260
C089-08N, C089-10N	271
C089-15 / C089-19A	274
C089-15F	260
C089-17N, C089-19N	275
C089-21D, C089-22A	266
C089-21N, C089-22N	267
C089-22F	260
C089F	260
C090	288, 290

C090-01 / C090-03A	290	C104-51	70
C090-06	288	C104N	224-228
C090-06D / C090-07N	294	C105	313
C090-06F	260	C106	315
C090-12, C090-13	295	C106-10	420, 424
C090-13C	294	C107, C107-01	316
C090-14	295, 306	C107-09 / C107-29	316, 350
C090-14SP	302	C108N	219-221, 413
C090-15	293, 295, 299, 303, 305	C109-09N	289, 307
C090-16	303, 305	C109-10	221
C090-18	189, 190, 207, 303, 305	C109-10N	259, 281, 448
C090-19	306	C109-11	221
C090-20	303, 305	C109-11N	18
C090-21	295	C109-12	221
C090F	260	C109-12N	259, 281, 322, 512
C091	288	C109-14N	303, 305
C091-01F	260	C109-15	293, 295
C091-02D / C091-03N	292	C109-15N	282, 283, 298, 303
C091-10 / C091-14	293	C109-16	291, 293, 295, 309
C091-13	293, 295, 309, 315	C109-16N	18
C092-01	310	C109N	222-228, 414
C092-05, C092-06	311, 429	C110	320
C092-07	429	C110-01 / C110-14	320
C092-09	438, 447	C110-15	319
C092-11	310	C110-30	316
C092-15	311	C111	320
C093	289	C111-01	232, 236, 240
C093-02D / C093-03N	308	C111-02 / C111-50	320
C093-05N	289, 307	C111-05, C111-06	248, 252, 256
C093-11	293, 295, 299, 309, 321, 506, 513	C111-07	252
C094N	323	C111-12 / C111-15	264, 268, 272, 276
C095	323	C112-05 / C112-11	320
C095-05	321	C113	318
C095F	260	C114, C114-01	318
C095N	289, 296-299	C114-10N	318
C096	323	C115-01, C115N	318
C096F	260	C116-01N / C116-13N	318
C096N	289, 300-303	C116-09S	518, 519
C097-01, C097-08	313	C117	259, 268, 276, 279, 281
C098-01N	221	C118-03 / C118-14	317
C098N	219-221, 413	C121	317
C099-01	223	C121-01 / C121-10	317
C099N	223	C121-51	317
C100	314	C122	319
C100-01, C100-02	314, 512	C122-01 / C122-07	319
C101	314	C123	221
C101-01	314, 512	C123-01N	448
C102	314	C123N	69, 285, 431
C103	314, 512	C125-01N	285
C103-01, C103-02	314	C125-09 / C125-15	69, 285, 431
C104-01N	228	C125N	284
C104-02N	228	C126	317
C104-04	218, 228	C127-11	221, 420, 424, 427
C104-05	19, 227	C127N	221
C104-06	223	C128	313
C104-09	228	C129	324
C104-10N	282, 283	C129-01N, C129-02	324
C104-31, C104-31SP	283	C130-05	286, 287



C130N	287	C200 / C205-01	337
C131N1	287	C208, C208-01	338
C132-01N, C132N	287	C211	335
C133, C133-01	287	C213	335
C134, C134-10	69, 285, 286, 431	C214, C214-01	338
C138-05	146, 327	C216, C216-01	338
C138-10	146	C220	335
C138-11 / C138-14	327	C223	340
C138N	146, 326, 448	C223-01, C223-05	341
C140	327	C224	340
C140-01 / C140-09	327	C228, C228-01	341
C140-10	327, 448	C229	341
C142	326, 327	C230-01	341, 342
C142-01 / C142-08	327	C230-03, C230-05	341
C154, C154-01	325	C230L, C230N	340
C155-05	325	C231N1	341
C155-10N	325, 327	C232, C232N	340
C155N	325	C232-01	341
C161	329	C233-05	341
C162	329	C234-02, C234-03	341
C162-01, C162-02	329	C235, C235-01	341
C163	328	C237	341
C164, C164-01	328	C238	341
C165	328	C247	342
C165N	329	C247-01 / C347-03	342
C170	331	C248	342
C170-01	330	C248-01 / C248-05	342
C171, C171-11	330	C249, C249-01	342
C172	330	C250-10 / C250-17CER	339
C173	330	C253	343
C174-01N	331	C253-01 / C253-06	343
C174N	331	C254	342
C176-01	332	C254-01	342, 362
C178 KIT	332	C254-02 / C254-05	342
C178-01	332	C258	342
C179 KIT	332	C258-01 / C258-06	342
C179-01, C179-02	332	C259-05, C259-06	343
C180 KIT	332	C261 / C265	343
C180-01/C180-07	332, 333	C271-10N	345
C180-02	332, 333, 343	C271N	345
C181	330, 332, 333	C272, C272-10	345
C181-51	278	C274-01M / C274-03M	345
C181P	333	C274M, C274M KIT	345
C182 KIT	332	C278	344
C182P KIT	333	C278-01, C278-02	344
C183	331	C279	344
C184N, C184-10N	331	C279-01, C279-04	345
C185	333	C279-02	60, 345, 473
C186 / C190	334	C281-01 / C281-04	344
C192 KIT	333	C281-05	345
C192-01, C192-02	333	C281N	344
C194, C194-01	335	C282	344
C195, C195-01	336	C290-01 / C292-01	351
C196	336	C294-01 / C294-05	351
C197, C197-01	336	C296	351
C198	336	C298	65
C199	337	C299	65, 352
C199-10, C199-11	337	C299-10	352

C300-01/ C300-09N	352-353
C300-02	65, 352
C300-08	65, 353
C302 KIT, C302-10 KIT	346
C302-01	346
C302-11	347
C304	346
C304-01, C304-02	346
C305-01	347
C305M	404
C306-01 / C306-05	347
C306-03	87, 134, 347, 474, 475
C307	347
C309-10 / C309-14	347
C311-01	347, 350
C312-02 / C312-11	350
C313N, C313-01N	26, 348
C313-05N / C313-15N	27, 349
C316N	26, 348
C318-10	355
C318N	355
C319, C319-02	356
C322, C322-01	357
C324N	355
C330	357
C331, C331-02	356
C332	355
C339-01 / C339-05	120, 357
C344, C344-01	357
C345	357
C346 / C346-04	120, 357
C348T	358
C349T	358
C350-01T	358
C350-10/ C350-17	358
C350T	358
C351 / C353	358
C358-01 / C358-16	360
C358-21	361
C358-23N	361
C360 KIT / C363-03	359
C364	362
C365	362
C366-11, C366-12	362
C369N	63, 371
C370-02 / C370-10	371, 373
C372-10, C372-11	371, 373
C372M	372
C373-10N / C373-13	367
C374, C374-06	364
C375-01	365
C375-02N	364
C375-10 KIT	365
C375-11	365
C376	363
C376-01 / C376-15	363
C376N	363
C377 / C377-16	66, 354

C378N	366
C380, C380-01	368
C381	64, 368
C382 / C383-10	368
C386N	369
C390	64, 368
C393	370
C396-01N	375
C396N	374
C399	359
C403-01, C403-02	374
C403-10	376
C405-10	377
C405-15N	67, 361, 377, 518-520
C405-20 / C405-30	377
C405N	378
C406N	378
C407-02	378
C408 / C408-03	378
C410 / C410-10	376
C411-01N	374
C411N	375
C412-01	375
C414	375
C426	362
C430	379
C432-01 / C432-06	379
C433	379
C435 / C435-11	380

<b>E</b>	<b>Page</b>
E009 KIT	384
E010-01 / E010-08	384
E011N, E011-01	384
E014 /E025	385
E027, E027-01	386
E028	386
E028-01, E028-02	386
E029	385
E031, E031-01	387
E034 / E034-12	386
E035	386
E035-10	394
E036 KIT	387
E036-01, E036-02	387
E037 / E037-10	388
E038 / E038-12	388
E039-01	387
E042-01N, E042-02N	389, 393
E042-06N	393
E042N	389, 393
E043	393
E044-03N	392
E044-06	393
E044-11 / E044-13	392
E044-30	393
E044-40N	389, 393
E044-41, E044-45	393



H003-03 / H003-22	441
H003-99	440
H003N	440
H004N / H008N	442-449
H005-11 / H005-31	444, 452, 507, 513
H005-40 / H005-51	444
H007-11 / H007-44	444
H008-11 / H008-44	444
H009-01	313
H009-01EN	221
H009-01N	562
H009N	449
H010	446
H011N, H011-01N	446
H011-15	448
H012-01, H012-02	448
H013-01, H013-02	448
H014	439, 445, 448
H014-06 / H014-08	439, 445, 448
H014-09	439, 445
H014-10	439, 445, 448
H014-11, H014-12	439, 445
H017	450
H017-05	450
H017-10 / H017-60	451
H020	453
H021	453
H050	453
H052	453
H054	453
H057-10N, H057-11N	453
H057N	453
H060-03	456
H060N	456
H062	456
H062-01, H062-03	456
H065N, H065-01	454
H066-01 / H066-63	455
H067-01 / H067-04	455
H068-01 / H068-23	455

<b>S</b>	<b>Page</b>
S043-02N	504
S050	460
S051	460
S051-01	461
S051-10 / S051-12	460
S052 KIT	461
S052-01 / S052-05	461
S053, S053-04	461, 463
S054	461, 463
S057, S057-01	460
S058	466
S058-11, S058-12	466
S059	467
S059-01, S059-02	467
S059-10	467
S060	466

S061 / S061-02	463
S065 / S076-01	464
S077	468
S078-01	468
S079	468
S083 KIT	463
S083-01 / S083-03	463
S084 KIT	463
S084-01	463
S086	465
S088	465
S088-10	465
S092 KIT / S094 KIT	462
S092-01	461
S093-01	461
S094-01	461
S095	461, 462
S096	462
S096-03 / S096-06	462
S097	462
S097-03 / S097-06	462
S110	470
S110-01 / S110-04	470
S111	470
S112	470
S113-10 / S113-17	470
S114	97, 470, 48,5 489
S118	471
S120, S120-01	471
S122 / S122-21	471, 529
S122-08 / S122-12	471, 538
S122-13 / S122-16	471, 546
S122-21	471, 538
S123 / S123-05	471, 529
S123-08 / S123-12	471, 538
S123-13 / S123-16	471, 546
S123-17	471, 538
S124, S125	471, 595
S131 KIT	492
S131-11	492
S132-01	60, 86, 469, 585
S132-02	60, 469, 585
S132-03	52, 60, 469, 585
S132N	60, 469
S133N	469
S135 / S138	469
S140	472
S143 KIT	475
S144, S144-01	52, 475
S144-02 / S144/10	475
S147	54, 479
S148	54, 136, 479
S155 KIT	474
S155-01 / S155-11	474
S155S KIT	474
S156	474
S156-01 KIT / S156-13	474
S156-20	52

S157 KIT	52, 475	S200-11	330, 331, 408, 489
S157-01 / S157-04	52, 475	S200-12N	489
S157-05	52, 475, 587	S200-13N	489
S157-06	52, 142, 475	S200-14	97, 489, 601
S157-07 / S157-10	52, 475	S201 / S201-06	489
S157-20	52, 475	S202-03 / S202-10N	489
S158 KIT	50, 476	S202N	489
S158-01GN	51, 477	S203, S203-01	489
S158-01N	50, 51, 476, 477	S205-05N	416, 452, 500-507
S158-02 / S158-13	50, 476, 477	S205-07, S205-08N	416, 417, 506
S158-03N	50, 51, 476, 477	S205-09	452, 507
S158-20 KIT	50, 476	S205-11	322, 503
S159 KIT	50, 477	S205-13	506
S159-01KIT	50, 477	S205-13A / S205-13C	506
S159-11	50, 477	S205-14	506
S160N, S160-01N	51, 478	S205-15	321, 322, 506, 513
S161	51, 478	S205-16	322, 506, 512
S164N	417	S205-18	321, 322, 507, 512
S165 KIT	482	S205N	126-129, 321, 416, 500-507
S165-01 KIT	483	S206-21N	18, 131, 511
S165-02 KIT	483	S206-31	131, 511, 512
S166 KIT	482	S206-32	417, 513
S166-01 / S166-06	483	S206-33	513
S170	480	S206N	130-131, 322, 417, 452, 508-513
S170-01, S170-05	480	S209 KIT	493
S172, S172-01	480	S209-01	493
S173-01 / S173-09	480	S210 KIT	492
S175	481	S210-02	493
S175-03, S175-04	481	S211 KIT	493
S176	481	S211-10	493
S178	481	S212-01	492-494, 503, 511
S178-01 / S178-06	481	S212-03	492-494
S179	481	S212-05	124, 127, 131, 416, 494, 503-505, 511
S185	484	S212-08N, S212-09N	494, 503
S185-01	485, 527	S212A	496
S186	484	S212N	124, 494, 496
S187, S187-01	485	S213-05N	124, 494
S188, S188-01	485, 489	S214-05N KIT	125, 495
S188-02	485	S215A	125, 496
S189 / S194-04	484	S216 KIT	495
S194-09 / S194-11	485	S218-01N	133, 499, 503
S194-14 / S194-26	489	S218-02N	503
S195-01 / S195-28	491	S218N	18, 133, 499, 503
S196N	490	S220 KIT	492
S197-01N	97, 490	S220-01	492
S197N1	97, 490	S221, S222-01	492
S198-22, S198-23	487	S222 KIT	514
S199	486	S222-01	514, 515, 518
S199-06 / S199-14	486	S222-02, S222-02D	514, 515
S199-11, S199-12	487	S222-03	514, 515, 516, 517, 518, 519
S199T	487	S222D KIT	514
S199T1	487	S223 KIT	515
S199T2	487	S223-01	514
S200	488	S223-02	516
S200-01N	489, 490	S223-03	519
S200-02 / S200-08	489	S223D KIT	515
S200-09	485, 489, 527	S224 KIT	518
S200-10N	489	S224-01 KIT	518

S224-02 KIT	519	S272 / S272-05	529
S224-21N	67, 518, 519	S273 KIT	530, 537, 538, 553
S225 KIT	516	S273-01 / S273-08	530
S225-01	167, 516, 518	S273-01 KIT	530
S225-02	167, 516	S273-02 KIT	530
S225-02D	514, 516	S274 KIT	529
S225D KIT	516	S274-01 KIT / S274-11 KIT	529
S226 KIT	517	S275	72, 529
S226-01 / S226-03	519	S276 KIT	536
S226-05	514-519	S276-01	537
S226-06	515-519	S276-02	540
S226-09	519	S276-10	537
S226-12	514	S276-11	540
S226-13	167, 515, 516, 518	S277	536
S226-16	514-519	S277-20	537, 540
S226-50	519	S277-31	537, 540
S226D KIT	517	S277-32	537
S227-02	517, 519	S277-40N	537, 539
S227-03, S227-03D	517	S277-41N	541, 542
S228-05 / S228-15	521	S280-15, S280-16	537, 541
S228N	521	S281 / S285	538
S230 KIT	523	S286 KIT / S286-05 KIT	538
S230-01	523	S290	538
S231 KIT	524	S291, S291-01	538
S231-01 / S231-11	524	S301	544
S232 KIT	523	S301-01	561-563
S232-01	523	S301-02	545
S233 KIT	523	S301-05, S301-06	544
S233-01	523	S301N	544, 545
S234 KIT	524	S303	564
S234-01 / S234-13	524	S305	503, 546, 563
S234-10 KIT	524	S305-05	496, 549, 563
S235, S235-01	524	S306	546, 563
S236 KIT	525	S307	563, 569
S236-01 KIT	525	S307-01 / S307-24	569
S236-05 / S236-12	525	S310, S310-01	199, 546
S237 KIT	525	S310-02 / S310-04	546
S237-05 / S237-07	525	S311, S311-01	199, 546
S238-01N KIT	522	S311-02 / S311-04	546
S238-10 / S238-16	522	S311-03	187, 188, 197, 546
S238N KIT	522	S312 / S312-05	546
S240-01 / S240-05	523	S313 / S313-14	546
S244	525	S314 / S314-04	546
S245-01 / S245-03	526	S314-03	187, 546
S245-04	525, 526	S315 / S315-07	546
S246-01	526	S315-07	187, 546
S248	527	S316 / S316-04	546
S252 / S252-02	526, 527	S316-03	187, 546
S253 / S253-02	526, 527	S317 / S317-04	546
S260	528	S318 / S318-04	546
S260-05N	528, 531	S319 / S319-04	546
S260-13	530	S320 / S320-04	546
S262-05N	534	S321	546
S262-11	533, 541	S322	546
S262-12N	533-535	S325	72, 526, 546, 551
S262N	533	S326 / S331	546
S265, S265-01	530	S334	528, 559, 560
S268 / S268-05	529	S334-01	560

S334-11, S334-12	535, 560
S335-10N	544, 554
S335-15	129, 496, 505, 518, 519, 549, 553, 563
S336-11	287, 303, 305, 528, 533, 537, 540, 549
S336-12	537, 540, 549, 553
S336-13	549
S336-14	133, 283, 306, 496, 499, 518, 549, 553
S336-15	129, 505, 549
S336-16	549, 553
S336-17, S336-18	549
S336-22	548
S336-23	563
S336-30	528, 549, 552
S336-31	518, 519, 528, 537, 549, 552
S336-32	528, 549, 552
S336-41, S336-43	520, 530, 541, 549
S336-45	520, 541, 549
S336-47	520, 541, 549
S336-50, S336-51	552
S336-53	563, 565, 569
S336-55	552, 563, 565, 569
S337-02 / S337-05	548
S337-06	569
S337-21	548
S337-23	569
S337-31	129, 503, 505, 548
S337-32	129, 321, 416, 505, 513, 548
S337-33	129, 548
S337-34	127-133, 321, 416, 496, 503-507, 511, 548
S337-35	129, 548
S337-36	452, 507
S337-41	563
S337-43	563
S337-51	286, 361, 377, 503-513, 520, 528, 533, 548
S338-01 KIT	553
S338-05	553
S338N	553
S340	551
S342-01 / S342-05	551
S342-03	563, 565, 569
S345	551
S348	551
S349	563, 565, 569
S349-10	563, 565, 569
S350-01	551
S350-04	550
S350-05N	550
S350N	550
S351N	550, 598
S355	550, 563, 569
S355-01	526, 550
S356N	552
S358	553
S359	553
S370 serie	573
S370-01 / S370-12	573
S370-01S	548
S370-02	492, 573

S370-02S	494
S370-03 / S370-08	573
S370-03S	537, 548
S370-04S / S370-07S	548
S370-08S	124, 494
S370-09	492, 573
S370-10	492, 493, 573
S370-10S	124, 494, 548
S371 serie	573
S371-01 / S371-12	573
S371-01S / S371-10S	548
S372 serie	573
S372-01 / S372-12	573
S373-05	573
S374	124, 493, 494, 548, 573, 574
S374-01	493
S374-02	573
S375	287, 362, 574
S375-01	528, 574
S376	362, 378, 489, 492-494, 528, 537, 574
S377	378, 489, 492, 514-517, 537, 549, 553, 574
S377-31 / S337-35	548
S378	378, 574
S379	378, 549, 553, 574
S379-01	574
S380, S380-01	574
S382-01	362, 574
S382-13	62, 359, 362, 378, 397, 574
S383	378, 549, 574
S390	574

<b>V</b>	<b>Page</b>
V014 / V017	578
V023-01	30, 473, 579
V023-02, V023-03	579
V031	578
V034	578
V035-01 / V035-08	579
V036 / V040-01	579
V041	54, 88, 337, 582
V042	582
V051	578
V057	578
V059	578
V065-02, V065-03	579
V070-02 / V070-06	581
V071-07 / V071-11	581
V072-02	581
V072-06N	581
V072-09	581
V073-01 / V073-06	581
V074-12	581
V074-13	581
V075-02 / V075-06	581
V075-11	88, 581
V075-12	581
V075-12SP	400
V075-13	581

V075-20 / V075-22	581	V127	330, 587
V085	54, 88, 337, 582	V127-01, V127-02	587
V085-01	337, 582	V128	587
V086	582	V135	587
V098 / V098-07	583	V135-01, V135-02	587
V099 / V099-07	583	V136	587
V100	583	V136-01	50, 476, 477, 587
V100-01	481, 583	V136-02	587
V100-02 / V100-07	583	V138	586
V101 / V101-07	583	V140	588
V101-03	153, 583	V142 / V142-05	586
V101-04	53, 583	V143 / V143-08	586
V101-07	52, 583	V145-10, V145-11	587
V102 / V102-04	587	V147, V147-01	586
V103	54, 583	V148, V148-01	589
V103-01	54, 583	V150 / V153	590
V103-02	583	V154 / V154-02	88, 590
V104 / V104-07	583	V154-03 / V154-06	590
V104-03	474, 583	V155	590
V105 / V105-03	583	V160 / V160-06	591
V105-04 / V104-06	54, 583	V161-01	591
V105-08	583	V162, V162-01	591
V106 / V106-04	583	V163	591
V107 / V107-14	584	V164 / V164-03	591
V108	479, 584	V165	410, 592
V108-01 / V108-03	54, 479, 584	V166-01	592
V108-10 / V108-12	584	V167, V167-01	589
V109 / V109-09	584	V168 / V168-04	589
V110 / V110-03	585	V169	589
V111, V111-01	146, 585	V170	50, 476, 592
V112	588	V170-01	592
V112-01	471, 588	V171	592
V112-02 / V112-04	588	V172	474, 592
V112-05	594	V172-02	474, 592
V113	471, 588	V172-03	474, 475
V114 / V114-06	588	V172-03N	592
V114-03	481, 588	V172-04	592
V114-10	79, 588	V172-05	61, 592
V115, V115-01	585	V173-01	593
V116 / V116-03	594	V173-01CE	593
V117 / V117-05	588	V173-02	593
V118 / V118-03	587	V173-03	82, 83, 593
V119 / V119-03	585	V173-04	83, 593
V120 / V120-03	587	V173-05, V173-06	593
V121	50, 476, 477, 524, 587	V174	161, 593
V121-01	587	V175	593
V122	481, 594	V175-01	593
V122-01, V122-02	594	V175-02	88, 339, 593
V122-03, V122-04	481, 594	V175-02CER	339
V122-05	139, 140, 149, 159, 483, 594	V175-03	53, 339, 593
V122-06	139, 140, 159, 483, 594	V175-03CER	339
V122-07	594	V175-04	593
V122-08	140, 483, 594	V176	593
V122-11	594	V176-01	332, 333, 593
V123, V123-01	585	V176-02	50, 476, 477, 593
V124	585	V177, V177-01	593
V125 / V125-18	594	V178	593
V125-03	61, 523, 594	V178-01	332, 333, 343, 593



V178-03	593	V215-01N	472, 599
V179	36, 593	V215-02N	599
V179-01	593	V215-11 / V215-14	599
V179-02	36, 593	V218-01 / V218-12	601
V179-03	36, 593	V219, V219-01	600
V179-04	593	V220 / V220-05	600
V179-05	36, 59, 593	V222	600
V179-06	36, 593	V224, V224-01	600
V182	343, 594	V225	600
V182-01 / V182-13	594	V226	600
V183	523, 595	V230	600
V184	332, 333, 595	V230-01	600
V184-01	343, 595	V230-02	525, 600
V184-02 / V184-05	595	V230-03	84, 387, 526, 550, 563, 569, 597, 600
V185 / V185-02	595	V241	601
V185-03	333, 595	V300	601
V186	523, 595	V300-05	601
V186-01	351, 595	V300-15	30, 479, 586, 601
V187	343, 595	V300-16	601
V188	523, 595	V300-19	28, 88, 395, 601
V189	595	V300-23	474, 601
V192	481, 595	V300-24	60, 469, 601
V192-01 / V192-07	595	V300-25	601
V192-08	385, 595	V300-28	52, 475, 601
V193	523, 595	V300-29	52, 475, 601
V194	523, 595	V300-30	472, 601
V194-01	595		
V195	343, 523, 595		
V196	595		
V197	595		
V198	523, 595		
V199	523, 595		
V200	28, 82, 83, 596		
V200-01	596		
V200-01N	28, 596		
V200-02	28, 82, 83, 596		
V200-03N	28, 596		
V200-05	596		
V200-05N	28, 596		
V200-06N	28, 596		
V201, V201-01	598		
V202	479, 597		
V203	83, 526, 597		
V204	597		
V205	387, 550, 563, 569, 597		
V205-01	84, 597		
V205-02	597		
V205-10	83, 84, 387, 550, 563, 569, 597		
V205-11	597		
V205-12	84, 550, 563, 569, 597		
V206	136, 380, 598		
V206-01	411, 598		
V206-02	411, 598		
V207	104, 533, 541, 550, 598		
V208-05	598		
V208-10	598		
V211, V211-01	599		
V215	472, 599		